



U.S. Department  
of Transportation  
**Federal Aviation  
Administration**

# Instrument Flying Handbook



# **Instrument Flying Handbook**

**2001**

U.S. DEPARTMENT OF TRANSPORTATION  
**FEDERAL AVIATION ADMINISTRATION**  
Flight Standards Service



# Preface

This Instrument Flying Handbook is designed for use by instrument flight instructors and pilots preparing for instrument rating tests. Instructors may find this handbook a valuable training aid as it includes basic reference material for knowledge testing and instrument flight training. Other Federal Aviation Administration (FAA) publications should be consulted for more detailed information on related topics.

This handbook conforms to pilot training and certification concepts established by the FAA. There are different ways of teaching, as well as performing, flight procedures and maneuvers and many variations in the explanations of aerodynamic theories and principles. This handbook adopts selected methods and concepts for instrument flying. The discussion and explanations reflect the most commonly used practices and principles. Occasionally the word “must” or similar language is used where the desired action is deemed critical. The use of such language is not intended to add to, interpret, or relieve a duty imposed by Title 14 of the Code of Federal Regulations (14 CFR).

All of the aeronautical knowledge and skills required to operate in instrument meteorological conditions (IMC) are detailed. Chapters are dedicated to human and aerodynamic factors affecting instrument flight, the flight instruments, attitude instrument flying for airplanes, basic flight maneuvers used in IMC, attitude instrument flying for helicopters, navigation systems, the National Airspace System (NAS), the air traffic control (ATC) system, instrument flight rules (IFR) flight procedures, and IFR emergencies. Clearance shorthand and an integrated instrument lesson guide are also included.

This handbook supersedes Advisory Circular (AC) 61-27C, Instrument Flying Handbook, which was revised in 1980. Comments regarding this handbook should be sent to U.S. Department of Transportation, Federal Aviation Administration, Airman Testing Standards Branch, AFS-630, P.O. Box 25082, Oklahoma City, OK 73125.

The current Flight Standards Service airman training and testing material and subject matter knowledge codes for all airman certificates and ratings can be obtained from the Flight Standards Service web site at: <http://afs600.faa.gov>.

This publication may be purchased from the Superintendent of Documents, P.O. Box 371954, Pittsburgh, PA 15250-7954, or from the U.S. Government Printing Office (GPO) bookstores located in major cities throughout the United States.

AC 00-2, Advisory Circular Checklist, transmits the current status of FAA ACs and other flight information publications. This checklist is free of charge and may be obtained by sending a request to U.S. Department of Transportation, Subsequent Distribution Office, SVC-121.23, Ardmore East Business Center, 3341 Q 75th Avenue, Landover, MD 20785. The checklist is also available on the internet at: <http://www.faa.gov/abc/ac-chklst/actoc.htm>.

## Acknowledgments

This book was produced as a combined FAA and industry effort.



# Introduction

## **Is an Instrument Rating Necessary?**

The answer to this question depends entirely upon individual needs. Pilots who fly in familiar uncongested areas, stay continually alert to weather developments, and accept an alternative to their original plan, may not need an Instrument Rating. However, some cross-country destinations may take a pilot to unfamiliar airports and/or through high activity areas in marginal visual or instrument meteorological conditions (IMC). Under these conditions, an Instrument Rating may be an alternative to rerouting, rescheduling, or canceling a flight. Many accidents are the result of pilots who lack the necessary skills or equipment to fly in marginal visual meteorological conditions (VMC) or IMC conditions and attempt flight without outside references.

Pilots originally flew aircraft strictly by sight, sound, and feel while comparing the aircraft's attitude to the natural horizon. As aircraft performance increased, pilots required more in-flight information to enhance the safe operation of their aircraft. This information has ranged from a string tied to a wing strut, to development of sophisticated electronic flight information systems (EFIS) and flight management systems (FMS). Interpretation of the instruments and aircraft control have advanced from the "one, two, three" or "needle, ball and airspeed" system to the use of "attitude instrument flying" techniques.

Navigation began by using ground references with dead reckoning and has led to the development of electronic navigation systems. These include the automatic direction finder (ADF), very-high frequency omnidirectional range (VOR), distance measuring equipment (DME), tactical air navigation (TACAN), long range navigation (LORAN), global positioning system (GPS), instrument landing system (ILS), microwave landing system (MLS), and inertial navigation system (INS).

Perhaps you want an Instrument Rating for the same basic reason you learned to fly in the first place—because you like flying. Maintaining and extending your proficiency, once you have the rating, means less reliance on chance and more on skill and knowledge. Earn the rating—not because you might

need it sometime, but because it represents achievement and provides training you will use continually and build upon as long as you fly. But most importantly—it means greater safety in flying.

## **Instrument Rating Requirements**

A Private or Commercial pilot who operates an aircraft using an instrument flight rules (IFR) flight plan operates in conditions less than the minimums prescribed for visual flight rules (VFR), or in any flight in Class A airspace, must have an Instrument Rating and meet the appropriate currency requirements.

You will need to carefully review the aeronautical knowledge and experience requirements for the Instrument Rating as outlined in Title 14 of the Code of Federal Regulations (14 CFR) part 61. After completing the FAA Knowledge Test issued for the Instrument Rating, and all the experience requirements have been satisfied, you are eligible to take the practical test. The regulations specify minimum total and pilot in command time requirements. This minimum applies to all applicants—regardless of ability or previous aviation experience.

## **Training for the Instrument Rating**

A person who wishes to add the Instrument Rating to their pilot certificate must first make commitments of time, money, and quality of training. There are many combinations of training methods available. Self-study alone may be adequate preparation to pass the required FAA Knowledge Test for the Instrument Rating. Occasional periods of ground and flight instruction may provide the skills necessary to pass the required test. Or, individuals may choose a training facility that provides comprehensive aviation education and the training necessary to ensure the pilot will pass all the required tests and operate safely in the National Airspace System (NAS). The aeronautical knowledge may be administered by educational institutions, aviation-oriented schools, correspondence courses, and appropriately-rated instructors. Each person must decide for themselves which training program best meets their needs and at the same time maintain a high quality of training. Interested persons should make

inquiries regarding the available training at nearby airports, training facilities, in aviation publications, and through the Federal Aviation Administration (FAA) Flight Standards District Office (FSDO).

Although the regulations specify minimum requirements, the amount of instructional time needed is determined not by the regulation, but by the individual's ability to achieve a satisfactory level of proficiency. A professional pilot with diversified flying experience may easily attain a satisfactory level of proficiency in the minimum time required by regulation. Your own time requirements will depend upon a variety of factors, including previous flying experience, rate of learning, basic ability, frequency of flight training, type of aircraft flown, quality of ground school training, and quality of flight instruction, to name a few. The total instructional time you will need, and in general the scheduling of such time, is up to the individual most qualified to judge your proficiency—the instructor who supervises your progress and endorses your record of flight training.

You can accelerate and enrich much of your training by informal study. An increasing number of visual aids and programmed instrument courses are available. The best course is one that includes a well-integrated flight and ground school curriculum. The sequential nature of flying requires that each element of knowledge and skill be learned and applied in the right manner at the right time.

Part of your instrument training may utilize a flight simulator, flight training device, or a personal computer-based aviation training device (PCATD). This ground-based flight training equipment is a valuable tool for developing your instrument cross-check and learning procedures such as intercepting and tracking, holding patterns, and instrument approaches. Once these concepts are fully understood, you can then continue with in-flight training and refine these techniques for full transference of your new knowledge and skills.

Holding the Instrument Rating does not necessarily make you a competent weather pilot. The rating certifies only that you have complied with the minimum experience requirements, that you can plan and execute a flight under IFR, that you can execute basic instrument maneuvers, and that you have shown acceptable skill and judgment in performing these

activities. Your Instrument Rating permits you to fly into instrument weather conditions with no previous instrument weather experience. Your Instrument Rating is issued on the assumption that you have the good judgment to avoid situations beyond your capabilities. The instrument training program you undertake should help you not only to develop essential flying skills but also help you develop the judgment necessary to use the skills within your own limits.

Regardless of the method of training selected, the curriculum in appendix 2 provides guidance as to the minimum training required for the addition of an Instrument Rating to a Private or Commercial pilot certificate.

### **Maintaining the Instrument Rating**

Once you hold the Instrument Rating, you may not act as pilot in command under IFR or in weather conditions less than the minimums prescribed for VFR, unless you meet the recent flight experience requirements outlined in part 61. These procedures must be accomplished within the preceding 6 months and include six instrument approaches, holding procedures, and intercepting and tracking courses through the use of navigation systems. If you do not meet the experience requirements during these 6 months, you have another 6 months to meet these minimums. If the requirements still are not met, you must pass an instrument proficiency check, which is an in-flight evaluation by a qualified instrument flight instructor using tasks outlined in the instrument rating practical test standards (PTSs).

The instrument currency requirements must be accomplished under actual or simulated instrument conditions. You may log instrument flight time during the time for which you control the aircraft solely by reference to the instruments. This can be accomplished by wearing a view-limiting device such as a hood, flying an approved flight-training device, or flying in actual IMC.

It takes only one harrowing experience to clarify the distinction between minimum practical knowledge and a thorough understanding of how to apply the procedures and techniques used in instrument flight. Your instrument training is never complete; it is adequate when you have absorbed every foreseeable detail of knowledge and skill to ensure a solution will be available if and when you need it.

# Contents

<b>Chapter 1</b>	
<b>Human Factors</b> .....	<b>1-1</b>
Introduction .....	1-1
Sensory Systems for Orientation .....	1-1
Eyes .....	1-1
Ears .....	1-2
Nerves .....	1-3
Illusions Leading to Spatial Disorientation .....	1-3
Inner Ear .....	1-3
The Leans .....	1-3
Coriolis Illusion .....	1-3
Graveyard Spiral .....	1-3
Somatogravic Illusion .....	1-4
Inversion Illusion .....	1-4
Elevator Illusion .....	1-4
Visual .....	1-4
False Horizon .....	1-4
Autokinesis .....	1-4
Postural .....	1-4
Demonstrating Spatial Disorientation .....	1-5
Climbing While Accelerating .....	1-5
Climbing While Turning .....	1-5
Diving While Turning .....	1-5
Tilting to Right or Left .....	1-5
Reversal of Motion .....	1-5
Diving or Rolling Beyond the Vertical Plane .....	1-5
Coping with Spatial Disorientation .....	1-6
Optical Illusions .....	1-6
Runway Width Illusion .....	1-6
Runway and Terrain Slopes Illusion .....	1-6
Featureless Terrain Illusion .....	1-6
Water Refraction .....	1-6
Haze .....	1-7
Fog .....	1-7
Ground Lighting Illusions .....	1-7
How to Prevent Landing Errors	
Due to Visual Illusions .....	1-7
Vision Under Dim and Bright Illumination .....	1-8
Physiological and Psychological Factors .....	1-8
Stress .....	1-8
Medical Factors .....	1-9
Alcohol .....	1-10
Fatigue .....	1-10
IMSAFE Checklist .....	1-10
Aeronautical Decision Making .....	1-10
The DECIDE Model .....	1-12
Hazardous Attitudes and Antidotes .....	1-12
Crew/Cockpit Resource Management .....	1-13
Human Resources .....	1-13
Hardware .....	1-13
Information Workload .....	1-13
<b>Chapter 2</b>	
<b>Aerodynamic Factors</b> .....	<b>2-1</b>
Introduction .....	2-1
Review of Basic Aerodynamics .....	2-1
The Four Forces .....	2-1
Newton's First Law .....	2-1
Newton's Second Law .....	2-2
Newton's Third Law .....	2-2
Atmosphere .....	2-3
Standard Atmosphere .....	2-3
Pressure Altitude .....	2-3
Density Altitude .....	2-3
Lift .....	2-3
Pitch/Power Relationship .....	2-3
Drag Curves .....	2-4
Regions of Command .....	2-5
Control Characteristics .....	2-5
Speed Stability .....	2-5
Normal Command .....	2-5
Reversed Command .....	2-6
Trim .....	2-6
Slow-Speed Flight .....	2-6
Small Airplanes .....	2-6
Large Airplanes .....	2-7
Climbs .....	2-7
Acceleration in Cruise Flight .....	2-7
Turns .....	2-7
Rate of Turn .....	2-8
Radius of Turn .....	2-8
Coordination of Rudder and Aileron Controls .....	2-8
Load Factor .....	2-9
Effects of Icing .....	2-9



<b>Chapter 3</b>	
<b>Flight Instruments</b> .....	<b>3-1</b>
Introduction .....	3-1
Pitot-Static Systems .....	3-1
Position Error .....	3-3
Pitot-Static Instruments .....	3-3
Sensitive Altimeter .....	3-3
Principle of Operation .....	3-3
Altimeter Errors .....	3-4
Encoding Altimeter .....	3-6
Absolute Altimeter .....	3-6
Airspeed Indicators .....	3-7
Types of Airspeed .....	3-7
Airspeed Color Codes .....	3-8
Vertical Speed Indicators (VSI) .....	3-8
Compass Systems .....	3-9
Magnetic Compass .....	3-9
Compass Errors .....	3-10
Vertical Card Magnetic Compasses .....	3-13
Flux Gate Compass .....	3-14
Remote Indicating Compass .....	3-15
Gyroscopic Systems .....	3-16
Power Sources .....	3-16
Electrical Systems .....	3-16
Pneumatic Systems .....	3-16
Gyroscopic Instruments .....	3-18
Attitude Indicators .....	3-18
Heading Indicators .....	3-19
Turn Indicators .....	3-20
Turn-and-Slip Indicator .....	3-20
Turn Coordinator .....	3-21
Flight Director Systems .....	3-22
Horizontal Situation Indicator (HSI) .....	3-22
Attitude Director Indicator (ADI) .....	3-22
Instrument Systems Preflight Procedures .....	3-23
Before Engine Start .....	3-23
After Engine Start .....	3-24
Taxiing and Takeoff .....	3-24
Engine Shut Down .....	3-24

<b>Chapter 4</b>	
<b>Airplane Attitude Instrument Flying</b> .....	<b>4-1</b>
Introduction .....	4-1
Control and Performance Method .....	4-1
Control Instruments .....	4-1
Performance Instruments .....	4-2
Navigation Instruments .....	4-2
Procedural Steps .....	4-2
Attitude Control .....	4-3
Pitch Control .....	4-3
Bank Control .....	4-3
Power Control .....	4-3
Primary and Supporting Method .....	4-3
Pitch Instruments .....	4-3
Bank Instruments .....	4-3
Power Instruments .....	4-3

Fundamental Skills .....	4-5
Cross-Check .....	4-5
Selected Radial Cross-Check .....	4-5
Inverted-V Cross-Check .....	4-5
The Rectangular Cross-Check .....	4-5
Common Cross-Check Errors .....	4-6
Instrument Interpretation .....	4-6
Aircraft Control .....	4-7

<b>Chapter 5</b>	
<b>Airplane Basic Flight Maneuvers</b> .....	<b>5-1</b>
Introduction .....	5-1
Straight-and-Level Flight .....	5-1
Pitch Control .....	5-1
Attitude Indicator .....	5-1
Altimeter .....	5-4
Vertical Speed Indicator .....	5-6
Airspeed Indicator .....	5-6
Bank Control .....	5-7
Attitude Indicator .....	5-7
Heading Indicator .....	5-8
Turn Coordinator .....	5-9
Power Control .....	5-9
Power Settings .....	5-11
Airspeed Changes in Straight-and-Level Flight ...	5-12
Trim Technique .....	5-14
Common Errors in Straight-and-Level Flight .....	5-14
Pitch .....	5-14
Heading .....	5-15
Power .....	5-15
Trim .....	5-15
Straight Climbs and Descents .....	5-16
Climbs .....	5-16
Entry .....	5-16
Leveling Off .....	5-19
Descents .....	5-19
Entry .....	5-20
Leveling Off .....	5-20
Common Errors in Straight Climbs and Descents ...	5-22
Turns .....	5-22
Standard-Rate Turns .....	5-22
Turns to Predetermined Headings .....	5-23
Timed Turns .....	5-24
Compass Turns .....	5-25
Steep Turns .....	5-26
Climbing and Descending Turns .....	5-28
Change of Airspeed in Turns .....	5-28
Common Errors in Turns .....	5-29
Pitch .....	5-29
Bank .....	5-29
Power .....	5-30
Trim .....	5-30
Errors During Compass Turns .....	5-30
Approach to Stall .....	5-30

Unusual Attitudes and Recoveries .....	5-31	Common Errors During Turns .....	6-16
Recognizing Unusual Attitudes .....	5-31	Unusual Attitudes .....	6-16
Recovery From Unusual Attitudes .....	5-32	Common Errors During Unusual	
Nose-High Attitudes .....	5-32	Attitude Recoveries .....	6-17
Nose-Low Attitudes .....	5-32	Emergencies .....	6-17
Common Errors in Unusual Attitudes .....	5-33	Autorotations .....	6-17
Instrument Takeoff .....	5-33	Common Errors During Autorotations .....	6-17
Common Errors in Instrument Takeoffs .....	5-34	Servo Failure .....	6-17
Basic Instrument Flight Patterns .....	5-35	Instrument Takeoff .....	6-18
Racetrack Pattern .....	5-35	Common Errors During Instrument Takeoffs .....	6-18
Standard Procedure Turn .....	5-35		
80/260 Procedure Turn .....	5-35		
Teardrop Pattern .....	5-36		
Circling Approaches Pattern .....	5-36		
Pattern I .....	5-36		
Pattern II .....	5-36		
		<b>Chapter 7</b>	
<b>Chapter 6</b>		<b>Navigation Systems .....</b>	<b>7-1</b>
<b>Helicopter Attitude Instrument Flying .....</b>	<b>6-1</b>	Introduction .....	7-1
Introduction .....	6-1	Basic Radio Principles .....	7-1
Flight Instruments .....	6-1	How Radio Waves Propagate .....	7-1
Instrument Flight .....	6-1	Ground Wave .....	7-1
Instrument Cross-Check .....	6-1	Sky Wave .....	7-2
Instrument Interpretation .....	6-3	Space Wave .....	7-2
Aircraft Control .....	6-3	Disturbances to Radio Wave Reception .....	7-2
Straight-and-Level Flight .....	6-3	Nondirectional Radio Beacon (NDB) .....	7-3
Pitch Control .....	6-3	Description .....	7-3
Attitude Indicator .....	6-3	NDB Components .....	7-3
Altimeter .....	6-5	ADF Components .....	7-3
Vertical Speed Indicator .....	6-5	Function of ADF .....	7-4
Airspeed Indicator .....	6-5	Orientation .....	7-4
Bank Control .....	6-6	Station Passage .....	7-4
Attitude Indicator .....	6-6	Homing .....	7-4
Heading Indicator .....	6-7	Tracking .....	7-5
Turn Indicator .....	6-7	Intercepting Bearings .....	7-7
Common Errors During Straight-and-Level Flight .....	6-7	Operational Errors of ADF .....	7-7
Power Control During Straight-and-Level Flight .....	6-8	Very-High Frequency Omnidirectional Range (VOR) ...	7-8
Common Errors During Airspeed Changes .....	6-10	Description .....	7-8
Straight Climbs		VOR Components .....	7-9
(Constant Airspeed and Constant Rate) .....	6-10	Function of VOR .....	7-10
Entry .....	6-10	Orientation .....	7-10
Level-Off .....	6-11	Tracking TO and FROM the Station .....	7-11
Straight Descents		Course Interception .....	7-11
(Constant Airspeed and Constant Rate) .....	6-12	VOR Operational Errors .....	7-12
Entry .....	6-12	VOR Accuracy .....	7-12
Level-Off .....	6-12	VOR Receiver Accuracy Check .....	7-13
Common Errors During		VOT .....	7-13
Straight Climbs and Descents .....	6-13	Certified Checkpoints .....	7-13
Turns .....	6-13	Distance Measuring Equipment (DME) .....	7-13
Turns to a Predetermined Heading .....	6-14	Description .....	7-13
Timed Turns .....	6-14	DME Components .....	7-13
Change of Airspeed in Turns .....	6-14	Function of DME .....	7-14
Compass Turns .....	6-15	DME Arc .....	7-14
30° Bank Turn .....	6-15	Intercepting Lead Radials .....	7-16
Climbing and Descending Turns .....	6-15	DME Errors .....	7-17

Area Navigation (RNAV) .....	7-17
Description .....	7-17
VOR/DME RNAV .....	7-17
VOR/DME RNAV Components .....	7-17
Function of VOR/DME RNAV .....	7-18
VOR/DME RNAV Errors .....	7-19
Long Range Navigation (LORAN) .....	7-19
LORAN Components .....	7-20
Function of LORAN .....	7-20
LORAN Errors .....	7-20
System Errors .....	7-20
Operational Errors .....	7-20
Global Positioning System (GPS) .....	7-21
GPS Components .....	7-21
Function of GPS .....	7-22
GPS Substitution .....	7-22
IFR Flight Using GPS .....	7-24
GPS Instrument Approaches .....	7-25
GPS Errors .....	7-26
Inertial Navigation System (INS) .....	7-27
INS Components .....	7-27
INS Errors .....	7-27
Instrument Approach Systems .....	7-27
Description .....	7-27
Instrument Landing Systems (ILS) .....	7-27
ILS Components .....	7-29
Ground Components .....	7-29
ILS Airborne Components .....	7-32
ILS Function .....	7-33
ILS Errors .....	7-34
Marker Beacons .....	7-34
Operational Errors .....	7-35
Simplified Directional Facility (SDF) .....	7-35
Localizer Type Directional Aid (LDA) .....	7-35
Microwave Landing System (MLS) .....	7-35
Approach Azimuth Station .....	7-36
Elevation Guidance Station .....	7-36
Range Guidance Station .....	7-36
Flight Management Systems (FMS) .....	7-36
Description .....	7-36
Function of FMS .....	7-36
Head-up Display (HUD) .....	7-37
Description .....	7-37
Radar Navigation (Ground Based) .....	7-37
Description .....	7-37
Functions of Radar Navigation .....	7-38
Airport Surface Detection Equipment .....	7-39
Radar Limitations .....	7-39

<b>Chapter 8</b>	
<b>The National Airspace System .....</b>	<b>8-1</b>
Introduction .....	8-1
Airspace Classification .....	8-1
Special Use Airspace .....	8-3
Federal Airways .....	8-4
Other Routing .....	8-4
IFR En Route Charts .....	8-6
Airport Information .....	8-6
Chartered IFR Altitudes .....	8-7
Navigation Features .....	8-8
Types of NAVAIDs .....	8-8
Identifying Intersections .....	8-8
Other Route Information .....	8-8
Weather Information and	
Communication Features .....	8-11
U.S. Terminal Procedures Publications .....	8-11
Departure Procedures (DPs) .....	8-11
Standard Terminal Arrival Routes (STARs) .....	8-13
Instrument Approach Procedures Charts (IAPs) .....	8-13
Margin Identification .....	8-13
The Plan View .....	8-16
Course Reversal Elements in	
Plan View and Profile View .....	8-18
Procedure Turns .....	8-18
Holding in Lieu of Procedure Turn .....	8-19
Teardrop Procedure .....	8-19
Terminal Arrival Area (TAA) .....	8-19
The Profile View .....	8-20
Minimums and Notes .....	8-23
Airport Diagram .....	8-25
Inoperative Components .....	8-28
RNAV Instrument Approach Charts .....	8-28
<b>Chapter 9</b>	
<b>The Air Traffic Control System .....</b>	<b>9-1</b>
Introduction .....	9-1
Communication Equipment .....	9-1
Navigation/Communication (NAV/COM)	
Equipment .....	9-1
Radar and Transponders .....	9-3
Mode C (Altitude Reporting) .....	9-3
Communication Procedures .....	9-4
Communication Facilities .....	9-4
Automated Flight Service Stations (AFSS) .....	9-4
Air Traffic Control Towers .....	9-5
Terminal Radar Approach Control (TRACON) .....	9-6
Tower En Route Control (TEC) .....	9-9
Air Route Traffic Control Centers (ARTCC) .....	9-9
Center Approach/Departure Control .....	9-10
Control Sequence .....	9-11
Letters of Agreement (LOA) .....	9-11

<b>Chapter 10</b>	
<b>IFR Flight</b>	<b>10-1</b>
Introduction	10-1
Sources of Flight Planning Information	10-1
Aeronautical Information Manual (AIM)	10-1
Airport/Facility Directory (A/FD)	10-1
Notices to Airmen Publication (NTAP)	10-2
POH/AFM	10-2
IFR Flight Plan	10-2
Filing in Flight	10-3
Canceling IFR Flight Plans	10-3
Clearances	10-3
Examples	10-3
Clearance Separations	10-4
Departure Procedures (DPs)	10-5
Radar Controlled Departures	10-5
Departures from Airports	
Without an Operating Control Tower	10-7
En Route Procedures	10-7
ATC Reports	10-7
Position Reports	10-7
Additional Reports	10-8
Planning the Descent and Approach	10-8
Standard Terminal Arrival Routes (STARs)	10-8
Substitutes for Inoperative	
or Unusable Components	10-10
Holding Procedures	10-10
Standard Holding Pattern (No Wind)	10-10
Standard Holding Pattern (With Wind)	10-10
Holding Instructions	10-11
Standard Entry Procedures	10-11
Time Factors	10-13
DME Holding	10-13
Approaches	10-13
Compliance with Published Standard Instrument	
Approach Procedures	10-13
Instrument Approaches to Civil Airports	10-14
Approach to Airport Without	
an Operating Control Tower	10-14
Approach to Airport With an Operating	
Tower, With No Approach Control	10-14
Approach to an Airport With an Operating	
Tower, With an Approach Control	10-17
Radar Approaches	10-17
Surveillance Approach	10-18
Precision Approach	10-19

No-Gyro Approach Under Radar Control	10-19
Timed Approaches From a Holding Fix	10-19
Approaches to Parallel Runways	10-20
Side-Step Maneuver	10-20
Circling Approaches	10-20
IAP Minimums	10-21
Missed Approaches	10-22
Landing	10-22
Instrument Weather Flying	10-23
Flying Experience	10-23
Recency of Experience	10-23
Airborne Equipment and Ground Facilities	10-23
Weather Conditions	10-23
Turbulence	10-23
Structural Icing	10-24
Fog	10-25
Volcanic Ash	10-25
Thunderstorms	10-25
Wind Shear	10-26
VFR-On-Top	10-27
VFR Over-The-Top	10-27
Conducting an IFR Flight	10-27
Preflight	10-27
Departure	10-33
En Route	10-34
Arrival	10-35

<b>Chapter 11</b>	
<b>Emergency Operations</b>	<b>11-1</b>
Introduction	11-1
Unforecast Adverse Weather	11-1
Inadvertent Thunderstorm Encounter	11-1
Inadvertent Icing Encounter	11-2
Precipitation Static	11-2
Aircraft System Malfunctions	11-3
Alternator/Generator Failure	11-3
Instrument Failure	11-3
Pneumatic System Failure	11-4
Pitot/Static System Failure	11-4
Communication/Navigation	
System Malfunction	11-4
Loss of Situational Awareness (SA)	11-5

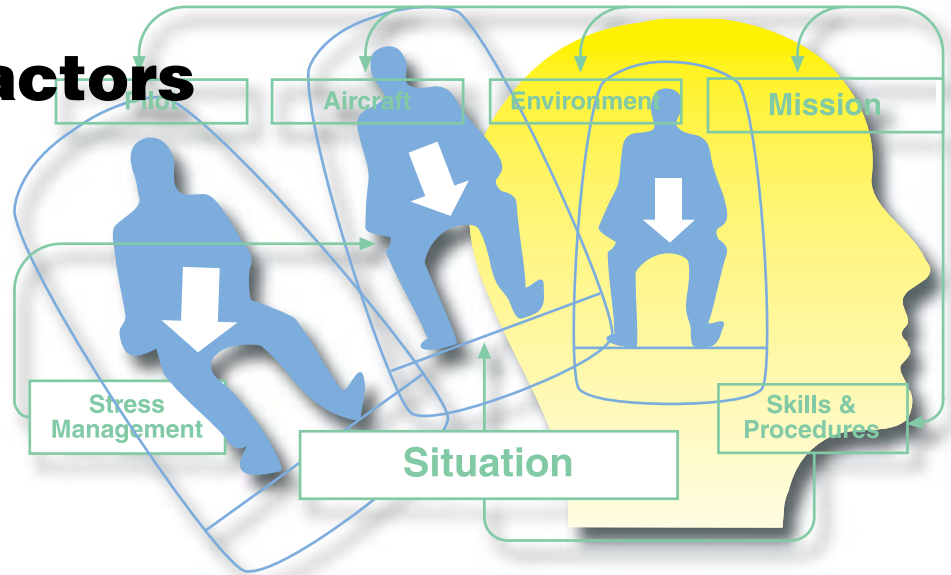
<b>Appendices</b>	
<i>Clearance Shorthand</i>	<b>Appendix 1-1</b>
<i>Instrument Training Lesson Guide</i>	<b>Appendix 2-1</b>

<b>Glossary</b>	<b>Glossary-1</b>
-----------------	-------------------

<b>Index</b>	<b>Index-1</b>
--------------	----------------



# Human Factors



## Introduction

**Human factors** is a broad field that studies the interaction between people and machines for the purpose of improving performance and reducing errors. As aircraft became more reliable and less prone to mechanical failure, the percentage of accidents related to human factors increased. Some aspect of human factors now accounts for over 80 percent of all accidents. Pilots who have a good understanding of human factors are better equipped to plan and execute a safe and uneventful flight.

Flying in instrument meteorological conditions (IMC) can result in sensations that are misleading to the body's sensory system. A safe pilot needs to understand these sensations and effectively counteract them. Instrument flying requires a pilot to make decisions using all available resources.

The elements of human factors covered in this chapter include sensory systems used for orientation, illusions in flight, physiological and psychological factors, medical factors, aeronautical decision making, and crew/cockpit resource management.

**Human factors:** A multidisciplinary field encompassing the behavioral and social sciences, engineering, and physiology, to consider the variables that influence individual and crew performance for the purpose of reducing errors.

## Sensory Systems for Orientation

**Orientation** is the awareness of the position of the aircraft and of oneself in relation to a specific reference point. Disorientation is the lack of orientation, and **spatial disorientation** specifically refers to the lack of orientation with regard to position in space and to other objects.

Orientation is maintained through the body's sensory organs in three areas: visual, vestibular, and postural. The eyes maintain visual orientation; the motion sensing system in the inner ear maintains vestibular orientation; and the nerves in the skin, joints, and muscles of the body maintain postural orientation. When human beings are in their natural environment, these three systems work well. However, when the human body is subjected to the forces of flight, these senses can provide misleading information. It is this misleading information that causes pilots to become disoriented.

### Eyes

During flight in visual meteorological conditions (VMC), the eyes are the major orientation source and usually provide accurate and reliable information. Visual cues usually prevail over false sensations from other sensory systems. When these visual cues are taken away, as they are in IMC, false sensations can cause the pilot to quickly become disoriented.

**Orientation:** Awareness of the position of the aircraft and of oneself in relation to a specific reference point.

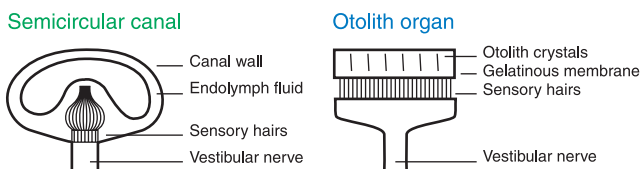
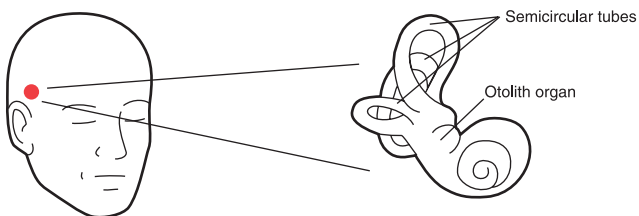
**Spatial disorientation:** The state of confusion due to misleading information being sent to the brain from various sensory organs, resulting in a lack of awareness of the aircraft position in relation to a specific reference point.

The only effective way to counter these false sensations is to recognize the problem, disregard the false sensations, and while relying totally on the flight instruments, use the eyes to determine the aircraft attitude. The pilot must have an understanding of the problem and the self-confidence to control the aircraft using only instrument indications.

### Ears

The inner ear has two major parts concerned with orientation, the semicircular canals and the otolith organs. [Figure 1-1] The semicircular canals detect angular acceleration of the body while the otolith organs detect linear acceleration and gravity. The semicircular canals consist of three tubes at right angles to each other, each located on one of the three axes: pitch, roll, or yaw. Each canal is filled with a fluid called endolymph fluid. In the center of the canal is the cupola, a gelatinous structure that rests upon sensory hairs located at the end of the **vestibular** nerves.

Our motion sensing system is located in each inner ear in the approximate position shown.

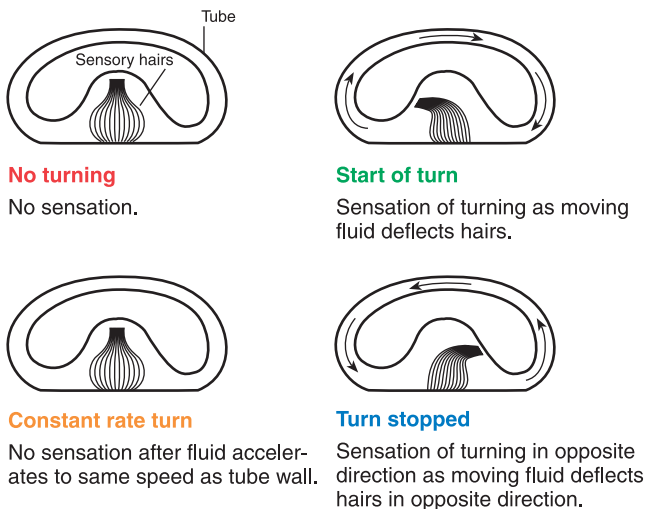
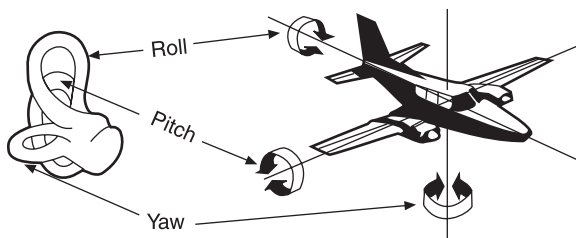


**Figure 1-1.** Inner ear orientation.

Figure 1-2 illustrates what happens during a turn. When the ear canal is moved in its plane, the relative motion of the fluid moves the cupola, which, in turn, stimulates the sensory hairs to provide the sensation of turning. This effect can be demonstrated by taking a glass filled with water and turning it slowly. The wall of the glass is moving, yet the water is not. If these sensory hairs were attached to the glass, they would be moving in relation to the water, which is still standing still.

**Vestibular:** The central cavity of the bony labyrinth of the ear, or the parts of the membranous labyrinth that it contains.

The semicircular tubes are arranged at approximately right angles to each other, in the roll, pitch, and yaw axes.

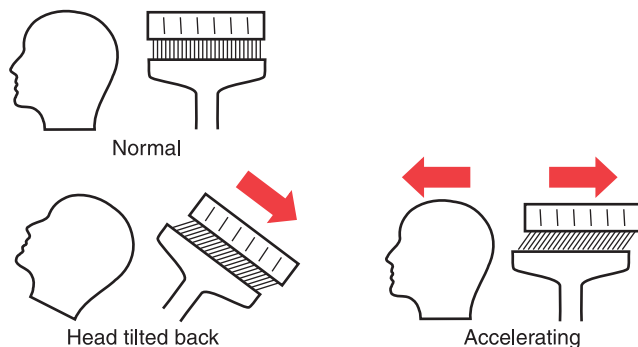


**Figure 1-2.** Angular acceleration.

The ear was designed to detect turns of a rather short duration. After a short period of time (approximately 20 seconds), the fluid accelerates due to friction between the fluid and the canal wall. Eventually, the fluid will move at the same speed as the ear canal. Since both are moving at the same speed, the sensory hairs detect no relative movement and the sensation of turning ceases. This can also be illustrated with the glass of water. Initially, the glass moved and the water did not. Yet, continually turning the glass would result in the water accelerating and matching the speed of the wall of the glass.

The pilot is now in a turn without any sensation of turning. When the pilot stops turning, the ear canal stops moving but the fluid does not. The motion of the fluid moves the cupola and therefore, the sensory hairs in the opposite direction. This creates the sensation of turning in the opposite direction even though the turn has stopped.

The otolith organs detect linear acceleration and gravity in a similar way. Instead of being filled with a fluid, a gelatinous membrane containing chalk-like crystals covers the sensory hairs. When the pilot tilts his/her head, the weight of these crystals causes this membrane to shift due to gravity and the sensory hairs detect this shift. The brain orients this new position to what it perceives as vertical. Acceleration and deceleration also cause the membrane to shift in a similar manner. Forward acceleration gives the illusion of the head tilting backward. [Figure 1-3]



**Figure 1-3.** *Linear acceleration.*

### Nerves

Nerves in the body’s skin, muscles, and joints constantly send signals to the brain, which signals the body’s relation to gravity. These signals tell the pilot his/her current position. Acceleration will be felt as the pilot is pushed back into the seat. Forces created in turns can lead to false sensations of the true direction of gravity, and may give the pilot a false sense of which way is up.

Uncoordinated turns, especially climbing turns, can cause misleading signals to be sent to the brain. Skids and slips give the sensation of banking or tilting. Turbulence can create motions that confuse the brain as well. Pilots need to be aware that fatigue or illness can exacerbate these sensations and ultimately lead to subtle incapacitation.

## Illusions Leading to Spatial Disorientation

The sensory system responsible for most of the illusions leading to spatial disorientation is the vestibular system in the inner ear. The major illusions leading to spatial disorientation are covered below.

### Inner Ear

#### *The Leans*

A condition called the **leans** can result when a banked attitude, to the left for example, may be entered too slowly to set in motion the fluid in the “roll” semicircular tubes. [Figure 1-2] An abrupt correction of this attitude can now set the fluid in motion, creating the illusion of a banked attitude to the right. The disoriented pilot may make the error of rolling the aircraft into the original left-banked attitude or, if level flight is maintained, will feel compelled to lean to the left until this illusion subsides.

#### *Coriolis Illusion*

The pilot has been in a turn long enough for the fluid in the ear canal to move at the same speed as the canal. A movement of the head in a different plane, such as looking at something in a different part of the cockpit, may set the fluid moving thereby creating the strong illusion of turning or accelerating on an entirely different axis. This is called **Coriolis illusion**. This action causes the pilot to think the aircraft is doing a maneuver that it is not. The disoriented pilot may maneuver the aircraft into a dangerous attitude in an attempt to correct the aircraft’s perceived attitude.

For this reason, it is important that pilots develop an instrument cross-check or scan that involves minimal head movement. Take care when retrieving charts and other objects in the cockpit—if you drop something, retrieve it with minimal head movement and be alert for the Coriolis illusion.

#### *Graveyard Spiral*

As in other illusions, a pilot in a prolonged coordinated, constant-rate turn, will have the illusion of not turning. During the recovery to level flight, the pilot will experience the sensation of turning in the opposite direction. The disoriented pilot may return the aircraft to its original turn. Because an

**Leans:** An abrupt correction of a banked attitude, entered too slowly to stimulate the motion sensing system in the inner ear, can create the illusion of banking in the opposite direction.

**Coriolis illusion:** An abrupt head movement, while in a prolonged constant-rate turn that has ceased stimulating the motion sensing system, can create the illusion of rotation or movement in an entirely different axis.



aircraft tends to lose altitude in turns unless the pilot compensates for the loss in lift, the pilot may notice a loss of altitude. The absence of any sensation of turning creates the illusion of being in a level descent. The pilot may pull back on the controls in an attempt to climb or stop the descent. This action tightens the spiral and increases the loss of altitude; hence, this illusion is referred to as a **graveyard spiral**. At some point, this could lead to a loss of control by the pilot.

### Somatogravic Illusion

A rapid acceleration, such as experienced during takeoff, stimulates the otolith organs in the same way as tilting the head backwards. This action creates the **somatogravic illusion** of being in a nose-up attitude, especially in situations without good visual references. The disoriented pilot may push the aircraft into a nose-low or dive attitude. A rapid deceleration by quick reduction of the throttle(s) can have the opposite effect, with the disoriented pilot pulling the aircraft into a nose-up or stall attitude.

### Inversion Illusion

An abrupt change from climb to straight-and-level flight can stimulate the otolith organs enough to create the illusion of tumbling backwards, or **inversion illusion**. The disoriented pilot may push the aircraft abruptly into a nose-low attitude, possibly intensifying this illusion.

### Elevator Illusion

An abrupt upward vertical acceleration, as can occur in an updraft, can stimulate the otolith organs to create the illusion of being in a climb. This is called **elevator illusion**. The disoriented pilot may push the aircraft into a nose-low attitude. An abrupt downward vertical acceleration, usually in a downdraft, has the opposite effect, with the disoriented pilot pulling the aircraft into a nose-up attitude.

### Visual

Two illusions that lead to spatial disorientation, the false horizon and autokinesis, are concerned with the visual system.

**Graveyard spiral:** The illusion of the cessation of a turn while actually still in a prolonged coordinated, constant-rate turn, which can lead a disoriented pilot to a loss of control of the aircraft.

**Somatogravic illusion:** The feeling of being in a nose-up or nose-down attitude, caused by a rapid acceleration or deceleration while in flight situations that lack visual reference.

**Inversion illusion:** The feeling that the aircraft is tumbling backwards, caused by an abrupt change from climb to straight-and-level flight while in situations lacking visual reference.

**Elevator illusion:** The feeling of being in a climb or descent, caused by the kind of abrupt vertical accelerations that result from up- or downdrafts.

### False Horizon

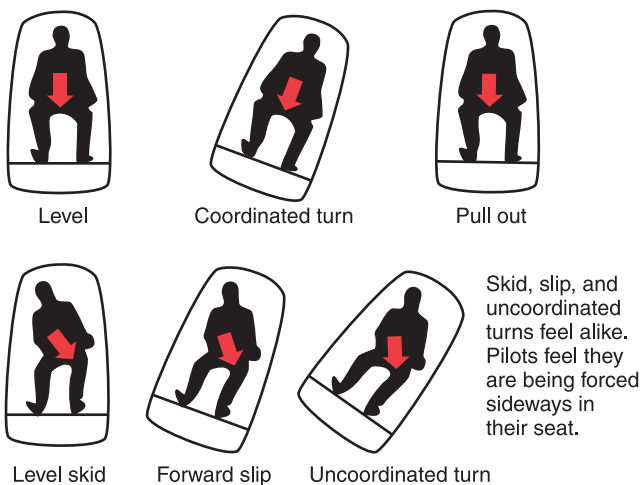
A sloping cloud formation, an obscured horizon, an aurora borealis, a dark scene spread with ground lights and stars, and certain geometric patterns of ground lights can provide inaccurate visual information, or **false horizon**, for aligning the aircraft correctly with the actual horizon. The disoriented pilot may place the aircraft in a dangerous attitude.

### Autokinesis

In the dark, a stationary light will appear to move about when stared at for many seconds. The disoriented pilot could lose control of the aircraft in attempting to align it with the false movements of this light, called **autokinesis**.

### Postural

The postural system sends signals from the skin, joints, and muscles to the brain that are interpreted in relation to the Earth's gravitational pull. These signals determine posture. Inputs from each movement update the body's position to the brain on a constant basis. "Seat of the pants" flying is largely dependent upon these signals. Used in conjunction with visual and vestibular clues, these sensations can be fairly reliable. However, because of the forces acting upon the body in certain flight situations, many false sensations can occur due to acceleration forces overpowering gravity. [Figure 1-4] These situations include uncoordinated turns, climbing turns, and turbulence.



**Figure 1-4.** Sensations from centrifugal force.

**False horizon:** Inaccurate visual information for aligning the aircraft caused by various natural and geometric formations that disorient the pilot from the actual horizon.

**Autokinesis:** Nighttime visual illusion that a stationary light is moving, which becomes apparent after several seconds of staring at the light.

## Demonstrating Spatial Disorientation

There are a number of controlled aircraft maneuvers a pilot can perform to experiment with spatial disorientation. While each maneuver will normally create a specific illusion, any false sensation is an effective demonstration of disorientation. Thus, even if there is no sensation during any of these maneuvers, the absence of sensation is still an effective demonstration in that it shows the inability to detect bank or roll. There are several objectives in demonstrating these various maneuvers.

1. They teach pilots to understand the susceptibility of the human system to spatial disorientation.
2. They demonstrate that judgments of aircraft attitude based on bodily sensations are frequently false.
3. They can help to lessen the occurrence and degree of disorientation through a better understanding of the relationship between aircraft motion, head movements, and resulting disorientation.
4. They can help to instill a greater confidence in relying on flight instruments for assessing true aircraft attitude.

A pilot should not attempt any of these maneuvers at low altitudes, or in the absence of an instructor pilot or an appropriate safety pilot.

### Climbing While Accelerating

With the pilot's eyes closed, the instructor pilot maintains approach airspeed in a straight-and-level attitude for several seconds, and then accelerates while maintaining straight-and-level attitude. The usual illusion during this maneuver, without visual references, will be that the aircraft is climbing.

### Climbing While Turning

With the pilot's eyes still closed and the aircraft in a straight-and-level attitude, the instructor pilot now executes, with a relatively slow entry, a well-coordinated turn of about 1.5 positive G (approximately 50° bank) for 90°. While in the turn, without outside visual references and under the effect of the slight positive G, the usual illusion produced is that of a climb. Upon sensing the climb, the pilot should immediately open the eyes and see that a slowly established, coordinated turn produces the same feeling as a climb.

### Demonstrating Spatial Disorientation—Safety Check

These demonstrations should never be conducted at low altitudes, or without an instructor pilot or appropriate safety pilot onboard.

### Diving While Turning

This sensation can be created by repeating the previous procedure, with the exception that the pilot's eyes should be kept closed until recovery from the turn is approximately one-half completed. With the eyes closed, the usual illusion will be that the aircraft is diving.

### Tilting to Right or Left

While in a straight-and-level attitude, with the pilot's eyes closed, the instructor pilot executes a moderate or slight skid to the left with wings level. The usual illusion is that the body is being tilted to the right.

### Reversal of Motion

This illusion can be demonstrated in any of the three planes of motion. While straight-and-level, with the pilot's eyes closed, the instructor pilot smoothly and positively rolls the aircraft to approximately a 45°-bank attitude while maintaining heading and pitch attitude. The usual illusion is a strong sense of rotation in the opposite direction. After this illusion is noted, the pilot should open the eyes and observe that the aircraft is in a banked attitude.

### Diving or Rolling Beyond the Vertical Plane

This maneuver may produce extreme disorientation. While in straight-and-level flight, the pilot should sit normally, either with eyes closed or gaze lowered to the floor. The instructor pilot starts a positive, coordinated roll toward a 30° or 40° angle of bank. As this is in progress, the pilot should tilt the head forward, look to the right or left, then immediately return the head to an upright position. The instructor pilot should time the maneuver so the roll is stopped just as the pilot returns his/her head upright. An intense disorientation is usually produced by this maneuver, with the pilot experiencing the sensation of falling downwards into the direction of the roll.

In the descriptions of these maneuvers, the instructor pilot is doing the flying, but having the pilot do the flying can also make a very effective demonstration. The pilot should close his/her eyes and tilt the head to one side. The instructor pilot tells the pilot what control inputs to perform. The pilot then attempts to establish the correct attitude or control input with eyes still closed and head still tilted. While it is clear the pilot has no idea of the actual attitude, he/she will react to what the senses are saying. After a short time, the pilot will become

disoriented and the instructor pilot then tells the pilot to look up and recover. The benefit of this exercise is the pilot actually experiences the disorientation while flying the aircraft.

## **Coping with Spatial Disorientation**

Pilots can take action to prevent illusions and their potentially disastrous consequences if they:

1. Understand the causes of these illusions and remain constantly alert for them.
2. Always obtain preflight weather briefings.
3. Do not continue flight into adverse weather conditions or into dusk or darkness unless proficient in the use of flight instruments.
4. Ensure that when outside visual references are used, they are reliable, fixed points on the Earth's surface.
5. Avoid sudden head movement, particularly during takeoffs, turns, and approaches to landing.
6. Remember that illness, medication, alcohol, fatigue, sleep loss, and mild hypoxia is likely to increase susceptibility to spatial disorientation.
7. Most importantly, become proficient in the use of flight instruments and rely upon them.

The sensations, which lead to illusions during instrument flight conditions, are normal perceptions experienced by pilots. These undesirable sensations cannot be completely prevented, but through training and awareness, pilots can ignore or suppress them by developing absolute reliance on the flight instruments. As pilots gain proficiency in instrument flying, they become less susceptible to these illusions and their effects.

## **Practice Makes Proficient**

Through training and awareness in developing absolute reliance on the instruments, pilots can reduce their susceptibility to disorienting illusions.

## **Optical Illusions**

Of the senses, vision is the most important for safe flight. However, various terrain features and atmospheric conditions can create **optical illusions**. These illusions are primarily associated with landing. Since pilots must transition from reliance on instruments to visual cues outside the cockpit for landing at the end of an instrument approach, it is imperative they are aware of the potential problems associated with these illusions, and take appropriate corrective action. The major illusions leading to landing errors are described below.

### **Runway Width Illusion**

A narrower-than-usual runway can create an illusion the aircraft is at a higher altitude than it actually is, especially when runway length-to-width relationships are comparable. [Figure 1-5A] The pilot who does not recognize this illusion will fly a lower approach, with the risk of striking objects along the approach path or landing short. A wider-than-usual runway can have the opposite effect, with the risk of leveling out high and landing hard, or overshooting the runway.

### **Runway and Terrain Slopes Illusion**

An upsloping runway, upsloping terrain, or both, can create an illusion the aircraft is at a higher altitude than it actually is. [Figure 1-5B] The pilot who does not recognize this illusion will fly a lower approach. Downsloping runways and downsloping approach terrain can have the opposite effect.

### **Featureless Terrain Illusion**

An absence of surrounding ground features, as in an overwater approach, over darkened areas, or terrain made featureless by snow, can create an illusion the aircraft is at a higher altitude than it actually is. This illusion, sometimes referred to as the "black hole approach," causes pilots to fly a lower approach than is desired.

### **Water Refraction**

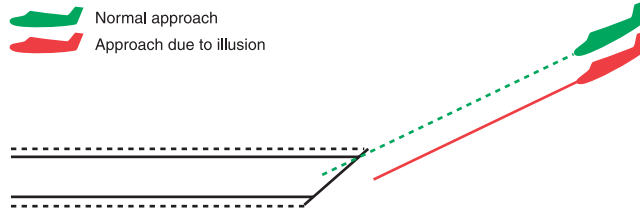
Rain on the windscreen can create an illusion of being at a higher altitude due to the horizon appearing lower than it is. This can result in the pilot flying a lower approach.

#### **Optical illusion:** *(in aircraft flight)*

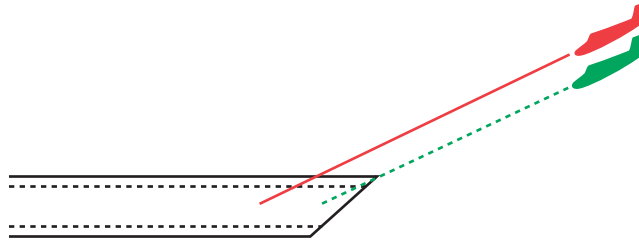
A misleading visual image of features on the ground associated with landing, which causes a pilot to misread the spatial relationships between the aircraft and the runway.

## A Runway width illusion

A narrower-than-usual runway can create an illusion that the aircraft is higher than it actually is, leading to a lower approach.

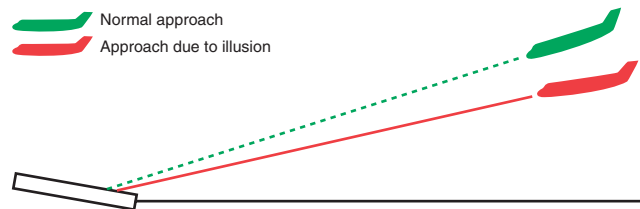


A wider-than-usual runway can create an illusion that the aircraft is lower than it actually is, leading to a higher approach.

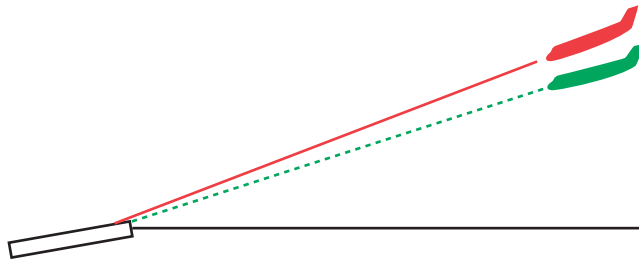


## B Runway slope illusion

An upsloping runway can create the illusion that the aircraft is higher than it actually is, leading to a lower approach.



A downsloping runway can create the illusion that the aircraft is lower than it actually is, leading to a higher approach.



**Figure 1-5.** Runway width and slope illusions.

## Haze

Atmospheric haze can create an illusion of being at a greater distance from the runway. As a result, the pilot will have a tendency to be high on the approach. Conversely, extremely clear air can give the pilot the illusion of being closer than he/she actually is, resulting in a long, low approach. The diffusion of light due to water particles can adversely affect depth perception. The lights and terrain features normally used to gauge height during landing become less effective for the pilot.

## Fog

Penetration of fog can create an illusion of pitching up. Pilots who do not recognize this illusion will often steepen the approach quite abruptly.

## Ground Lighting Illusions

Lights along a straight path, such as a road, and even lights on moving trains can be mistaken for runway and approach lights. Bright runway and approach lighting systems, especially where few lights illuminate the surrounding terrain, may create the illusion of less distance to the runway. The pilot who does not recognize this illusion will often fly a higher approach.

## How to Prevent Landing Errors Due to Visual Illusions

Pilots can take action to prevent these illusions and their potentially hazardous consequences if they:

1. Anticipate the possibility of visual illusions during approaches to unfamiliar airports, particularly at night or in adverse weather conditions. Consult airport diagrams and the *Airport/Facility Directory (A/FD)* for information on runway slope, terrain, and lighting.
2. Make frequent reference to the altimeter, especially during all approaches, day and night.
3. If possible, conduct aerial visual inspection of unfamiliar airports before landing.
4. Use **Visual Approach Slope Indicator (VASI)** or **Precision Approach Path Indicator (PAPI)** systems for a visual reference, or an electronic glide slope, whenever they are available.

**Visual Approach Slope Indicator (VASI):** A system of lights arranged to provide visual descent guidance information during the approach to the runway. A pilot on the correct glide slope will see red lights over white lights.

**Precision Approach Path Indicator (PAPI):** Similar to the VASI but consisting of one row of lights in two- or four-light systems. A pilot on the correct glide slope will see two white lights and two red lights.

5. Utilize the visual descent point (VDP) found on many nonprecision instrument approach procedure charts.
6. Recognize that the chances of being involved in an approach accident increase when some emergency or other activity distracts from usual procedures.
7. Maintain optimum proficiency in landing procedures.

## Vision Under Dim and Bright Illumination

Under conditions of dim illumination, aeronautical charts and aircraft instruments can become unreadable unless adequate cockpit lighting is available. In darkness, vision becomes more sensitive to light; this process is called **dark adaptation**. Although exposure to total darkness for at least 30 minutes is required for complete dark adaptation, a pilot can achieve a moderate degree of dark adaptation within 20 minutes under dim red cockpit lighting. Red light distorts colors, especially on aeronautical charts, and makes it very difficult for the eyes to focus on objects inside the aircraft. Pilots should use it only where optimum outside night vision capability is necessary. White cockpit lighting should be available when needed for map and instrument reading, especially under IMC conditions.

Dark adaptation is impaired by exposure to cabin pressure altitudes above 5,000 feet, carbon monoxide inhaled through smoking and from exhaust fumes, deficiency of Vitamin A in the diet, and by prolonged exposure to bright sunlight. Since any degree of dark adaptation is lost within a few seconds of viewing a bright light, pilots should close one eye when using a light to preserve some degree of night vision. During night flights in the vicinity of lightning, cockpit lights should be turned up to help prevent loss of night vision due to the bright flashes.

## Physiological and Psychological Factors

Several factors can affect the pilot, either physiologically or psychologically, to the point where the safety of a flight can be severely compromised. These factors are stress, medical, alcohol, and fatigue. Any of these factors, individually or in combination, can significantly degrade the pilot's decision-making or flying abilities, both in the flight planning phase and in flight.

**Dark adaptation:** Physical and chemical adjustments of the eye that make vision possible in relative darkness.

## Stress

**Stress** is the body's response to demands placed upon it. These demands can be either pleasant or unpleasant in nature. The causes of stress for a pilot can range from unexpected weather or mechanical problems while in flight, to personal issues totally unrelated to flying. Stress is an inevitable and necessary part of life; it adds motivation to life and heightens a pilot's response to meet any challenge. The effects of stress are cumulative, and there is a limit to a pilot's adaptive nature. This limit, the stress tolerance level, is based on a pilot's ability to cope with the situation.

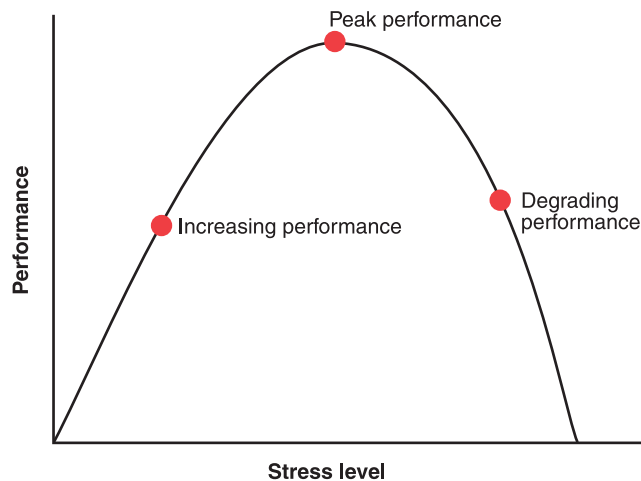
At first, some amount of stress can be desirable and can actually improve performance. Higher stress levels, particularly over long periods of time, can adversely affect performance. Performance will generally increase with the onset of stress, but will peak and then begin to fall off rapidly as stress levels exceed the ability to cope. [Figure 1-6A]

At the lower stress levels, boredom is followed by optimal performance at the moderate stress levels, then followed ultimately by overload and panic at the highest stress levels. At this point, a pilot's performance begins to decline and judgment deteriorates. Complex or unfamiliar tasks require higher levels of performance than simple or overlearned tasks. Complex or unfamiliar tasks are also more subject to the adverse effects of increasing stress than simple or familiar tasks. [Figure 1-6B]

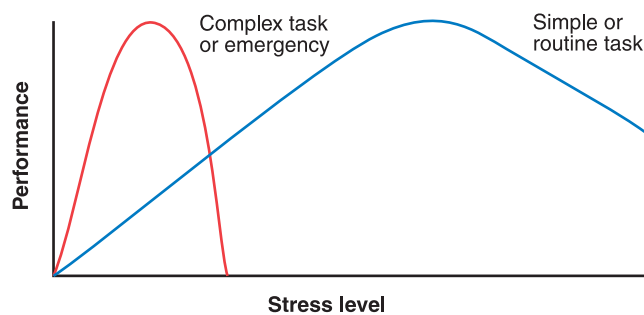
The indicators of excessive stress often show as three types of symptoms: (1) emotional, (2) physical, and (3) behavioral. These symptoms depend upon whether aggression is focused inward or outward. Individuals who typically turn their aggressive feelings inward often demonstrate the emotional symptoms of depression, preoccupation, sadness, and withdrawal. Individuals who typically take out their frustration on other people or objects exhibit few physical symptoms. Emotional symptoms may surface as overcompensation, denial, suspicion, paranoia, agitation, restlessness, defensiveness, excess sensitivity to criticism, argumentativeness, arrogance, and hostility. Pilots need to learn to recognize the symptoms of stress as they begin to occur within themselves.

**Stress:** The body's response to demands placed upon it.

## A Relationship between stress and performance



## B Stress and performance in complex and simple tasks



**Figure 1-6.** *Stress and performance.*

There are many techniques available that can help reduce stress in life or help people cope with it better. Not all of the following ideas may be the solution, but some of them should be effective.

1. Become knowledgeable about stress.
2. Take a realistic self-assessment.
3. Take a systematic approach to problem solving.
4. Develop a lifestyle that will buffer against the effects of stress.

5. Practice behavior management techniques.
6. Establish and maintain a strong support network.

Good cockpit stress management begins with good life stress management. Many of the stress-coping techniques practiced for life stress management are not usually practical in flight. Rather, pilots must condition themselves to relax and think rationally when stress appears. The following checklist outlines some methods of cockpit stress management.

1. Avoid situations that distract from flying the aircraft.
2. Reduce workload to reduce stress levels. This will create a proper environment in which to make good decisions.
3. If an emergency does occur, be calm. Think for a moment, weigh the alternatives, then act.
4. Become thoroughly familiar with the aircraft, its operation, and emergency procedures. Also, maintain flight proficiency to build confidence.
5. Know and respect personal limits.
6. Do not allow small mistakes to be distractions during flight; rather, review and analyze them after landing.
7. If flying adds stress, either stop flying or seek professional help to manage stress within acceptable limits.

## Medical Factors

A “go/no-go” decision is made before each flight. The pilot should not only preflight check the aircraft, but also his/herself before every flight. As a pilot you should ask yourself, “Could I pass my medical examination right now?” If you cannot answer with an absolute “yes,” then you should not fly. This is especially true for pilots embarking on flights in IMC. Instrument flying can be much more demanding than flying in VMC, and peak performance is critical for the safety of flight.

Pilot performance can be seriously degraded by both prescribed and over-the-counter medications, as well as by the medical conditions for which they are taken. Many medications, such as tranquilizers, sedatives, strong pain relievers, and cough-suppressants, have primary effects that may impair judgment, memory, alertness, coordination, vision, and the ability to make calculations. Others, such as

antihistamines, blood pressure drugs, muscle relaxants, and agents to control diarrhea and motion sickness, have side effects that may impair the same critical functions. Any medication that depresses the nervous system, such as a sedative, tranquilizer, or antihistamine, can make a pilot much more susceptible to hypoxia.

Title 14 of the Code of Federal Regulations (14 CFR) prohibits pilots from performing crewmember duties while using any medication that affects the faculties in any way contrary to safety. The safest rule is not to fly as a crewmember while taking any medication, unless approved to do so by the Federal Aviation Administration (FAA). If there is any doubt regarding the effects of any medication, consult an Aviation Medical Examiner (AME) before flying.

### **Alcohol**

14 CFR part 91 prohibits pilots from performing crewmember duties within 8 hours after drinking any alcoholic beverage or while under the influence. Extensive research has provided a number of facts about the hazards of alcohol consumption and flying. As little as one ounce of liquor, one bottle of beer, or four ounces of wine can impair flying skills and render a pilot much more susceptible to disorientation and **hypoxia**. Even after the body completely metabolizes a moderate amount of alcohol, a pilot can still be impaired for many hours. There is simply no way of increasing the metabolism of alcohol or alleviating a hangover.

### **Fatigue**

Fatigue is one of the most treacherous hazards to flight safety, as it may not be apparent to a pilot until serious errors are made. Fatigue can be either acute (short-term) or chronic (long-term). A normal occurrence of everyday living, acute fatigue is the tiredness felt after long periods of physical and mental strain, including strenuous muscular effort, immobility, heavy mental workload, strong emotional pressure, monotony, and lack of sleep. Acute fatigue is prevented by adequate rest, regular exercise, and proper nutrition. Chronic fatigue occurs when there is not enough time for a full recovery from repeated episodes of acute fatigue. Recovery from chronic fatigue requires a prolonged period of rest. In either case, unless adequate precautions are taken, personal performance could be impaired and adversely affect pilot judgment and decision making.

**Hypoxia:** A state of oxygen deficiency in the body sufficient to impair functions of the brain and other organs.

### **IMSAFE Checklist**

The following checklist, IMSAFE, is intended for a pilot's personal preflight use. A quick check of the items on this list can help the pilot make a good self-evaluation prior to any flight. If the answer to any of the checklist questions is yes, then the pilot should consider not flying.

**Illness**—Do I have any symptoms?

**Medication**—Have I been taking prescription or over-the-counter drugs?

**Stress**—Am I under psychological pressure from the job? Do I have money, health, or family problems?

**Alcohol**—Have I been drinking within 8 hours? Within 24 hours?

**Fatigue**—Am I tired and not adequately rested?

**Eating**—Have I eaten enough of the proper foods to keep adequately nourished during the entire flight?

### **Aeronautical Decision Making**

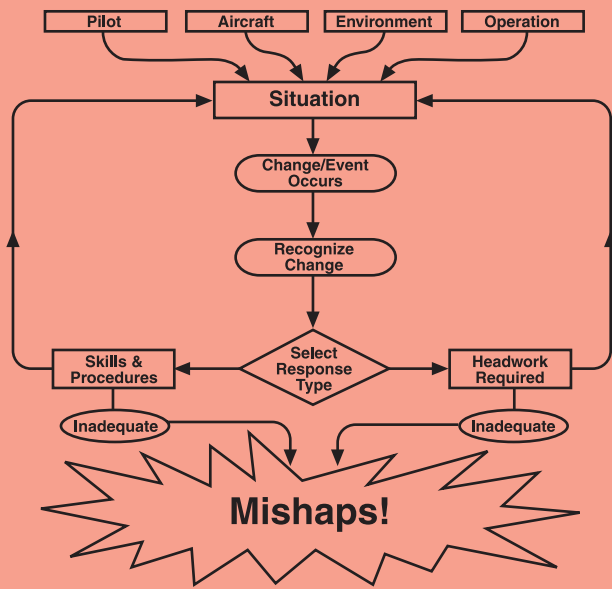
**Aeronautical decision making (ADM)** is a systematic approach to the mental process used by pilots to consistently determine the best course of action in response to a given set of circumstances. ADM builds upon the foundation of conventional decision making, but enhances the process to decrease the probability of pilot error. ADM provides a structure to analyze changes that occur during a flight and determine how these changes might affect a flight's safe outcome.

The ADM process addresses all aspects of decision making in the cockpit and identifies the steps involved in good decision making. These steps are:

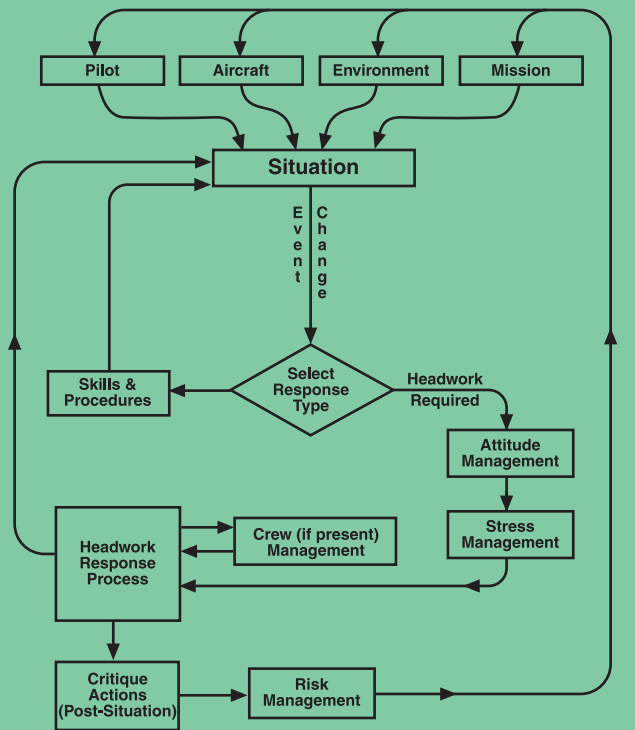
1. Identifying personal attitudes hazardous to safe flight.
2. Learning behavior modification techniques.
3. Learning how to recognize and cope with stress.
4. Developing risk assessment skills.
5. Using all resources.
6. Evaluating the effectiveness of one's ADM skills.

**Aeronautical decision making (ADM):** A systematic approach to the mental process used by pilots to consistently determine the best course of action in response to a given set of circumstances.

**Figure 1-7A**  
Conventional decision making process



**Figure 1-7B**  
Aeronautical decision making process



**Figure 1-7C**  
The DECIDE Model

1. **Detect.** The decision maker detects the fact that change has occurred.
2. **Estimate.** The decision maker estimates the need to counter or react to the change.
3. **Choose.** The decision maker chooses a desirable outcome (in terms of success) for the flight.
4. **Identify.** The decision maker identifies actions which could successfully control the change.
5. **Do.** The decision maker takes the necessary action.
6. **Evaluate.** The decision maker evaluates the effect(s) of his/her action countering the change.

**Figure 1-7.** Decision making.

In conventional decision making, the need for a decision is triggered by recognition that something has changed or an expected change did not occur. Recognition of the change, or nonchange, is a vital step in any decision making process. Not noticing the change in the situation can lead directly to a mishap. [Figure 1-7A] The change indicates that an appropriate response or action is necessary in order to modify

the situation (or, at least, one of the elements that comprise it) and bring about a desired new situation. Therefore, **situational awareness** is the key to successful and safe decision making. At this point in the process, the pilot is faced with a need to evaluate the entire range of possible responses to the detected change and to determine the best course of action.

**Situational awareness:** Knowing where you are in regard to location, air traffic control, weather, regulations, aircraft status, and other factors that may affect flight.



Figure 1-7B illustrates the ADM process, how this process expands conventional decision making, shows the interactions of the ADM steps, and how these steps can produce a safe outcome. Starting with the recognition of change, and following with an assessment of alternatives, a decision to act or not act is made, and the results are monitored. Pilots can use ADM to enhance their conventional decision making process because it: (1) increases their awareness of the importance of attitude in decision making; (2) teaches the ability to search for and establish relevance of information; (3) increases their motivation to choose and execute actions that ensure safety in the situational timeframe.

**The DECIDE Model**

A tool to use in making good aeronautical decisions is the DECIDE Model. [Figure 1-7C] The DECIDE Model is a six-step process intended to provide the pilot with a logical way of approaching decision making. The six elements of the DECIDE Model represent a continuous loop process to assist a pilot in the decision making when faced with a change in a situation that requires judgment. The model is primarily focused on the intellectual component, but can have an impact on the motivational component of judgment as well. If a pilot continually uses the DECIDE Model in all decision making, it becomes very natural and could result in better decisions being made under all types of situations.

**Hazardous Attitudes and Antidotes**

Research has identified five **hazardous attitudes** that can affect a pilot’s judgment, as well as antidotes for each of these five attitudes. ADM addresses the following:

1. Anti-authority (“Don’t tell me!”). This attitude is found in people who do not like anyone telling them what to do. They may be resentful of having someone tell them what to do or may regard rules, regulations, and procedures as silly or unnecessary. However, it is always your prerogative to question authority if you feel it is in error.
2. Impulsivity (“Do something quickly!”). This attitude is found in people who frequently feel the need to do something— anything— immediately. They do not stop to think about what they are about to do, they do not select the best alternative, and they do the first thing that comes to mind.

3. Invulnerability (“It won’t happen to me!”). Many people feel that accidents happen to others, but never to them. They know accidents can happen, and they know that anyone can be affected. They never really feel or believe that they will be personally involved. Pilots who think this way are more likely to take chances and increase risk.
4. Macho (“I can do it!”). Pilots who are always trying to prove that they are better than anyone else are thinking, “I can do it—I’ll show them.” Pilots with this type of attitude will try to prove themselves by taking risks in order to impress others. This pattern is characteristic in both men and women.
5. Resignation (“What’s the use?”). These pilots do not see themselves as being able to make a great deal of difference in what happens to them. When things go well, the pilot is apt to think it is due to good luck. When things go badly, the pilot may feel that someone is out to get them, or attribute it to bad luck. The pilot will leave the action to others, for better or worse. Sometimes, such pilots will even go along with unreasonable requests just to be a “nice guy.”

Hazardous attitudes, which contribute to poor pilot judgment, can be effectively counteracted by redirecting that hazardous attitude so that correct action can be taken. Recognition of hazardous thoughts is the first step toward neutralizing them. After recognizing a thought as hazardous, the pilot should label it as hazardous, then state the corresponding antidote. Antidotes should be memorized for each of the hazardous attitudes so they automatically come to mind when needed. Each hazardous attitude along with its appropriate antidote is shown in figure 1-8.

Hazardous Attitude	Antidote
Anti-authority: Don't tell me.	Follow the rules. They are usually right.
Impulsivity: Do something quickly.	Not so fast. Think first.
Invulnerability: It won't happen to me.	It could happen to me.
Macho: I can do it.	Taking chances is foolish.
Resignation: What's the use?	I'm not helpless. I can make a difference.

**Figure 1-8.** *The five antidotes.*

**Hazardous attitudes:** Five attitudes that contribute to poor pilot judgment while making decisions in flight: anti-authority, impulsivity, invulnerability, “macho,” and resignation.

## Crew/Cockpit Resource Management

**Crew/cockpit resource management (CRM)** is the effective use of all available resources; human resources, hardware, and information. While CRM is primarily focused on pilots operating in crew environments, many of the elements and concepts apply to single pilot operations.

### Human Resources

Human resources include all groups routinely working with pilots to ensure flight safety. These groups include, but are not limited to: weather briefers, flightline personnel, maintenance personnel, crewmembers, pilots, and air traffic personnel. Pilots must recognize the need to seek enough information from these sources to make a valid decision. After all of the necessary information has been gathered, the pilot's decision must be passed on to those concerned, such as other aircraft, air traffic controllers, crewmembers, and passengers. The pilot may have to request assistance from others and be assertive to safely resolve some situations.

CRM focuses on communication skills, teamwork, task allocation, and decision making. The single pilot needs to be able to effectively communicate with air traffic controllers, maintenance personnel, dispatchers, and other pilots. Key components of the communication process are inquiry, advocacy, and assertion.

Pilots should understand the need to seek further information from others until satisfied they have the proper information to make the best decision. Once a pilot has gathered all pertinent information and made the appropriate decision, the pilot needs to advocate the solution to others, such as air traffic controllers, to ensure the safe outcome of the flight. Pilots need to understand they must be assertive when seeking appropriate resolutions to problems they face.

### Hardware

Equipment in many of today's aircraft includes automated flight and navigation systems. These automatic systems, while providing relief from many routine cockpit tasks, present a different set of problems for pilots. Information from these systems needs to be continually monitored to ensure proper situational awareness.

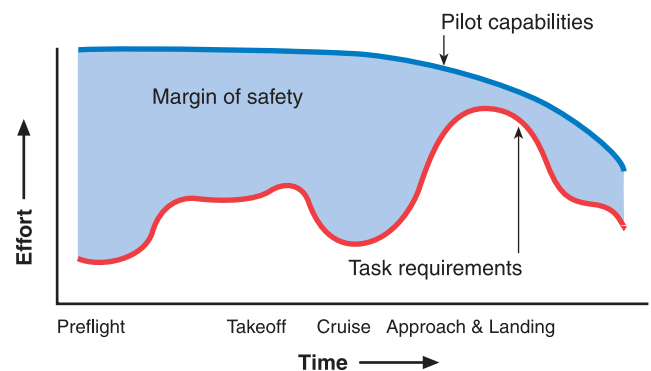
**Crew/cockpit resource management (CRM):** The effective use of all available resources — human resources, hardware, and information.

## Information Workload

Workloads need to be properly managed. The pilot flying in IMC is faced with many tasks, each with a different level of importance to the outcome of the flight. For example, a pilot preparing to execute an instrument approach to an airport needs to review the approach chart, prepare the aircraft for the approach and landing, complete checklists, obtain information from Automatic Terminal Information Service (ATIS) or air traffic control (ATC), and set the navigation radios and equipment.

The pilot who effectively manages his/her workload will complete as many of these tasks as early as possible to preclude the possibility of becoming overloaded by last minutes changes and communication priorities in the later, more critical stages of the approach. Figure 1-9 shows the margin of safety is at the minimum level during this stage of the approach. Routine tasks that have been delayed until the last minute can contribute to the pilot becoming overloaded and stressed, resulting in an erosion of performance.

By planning ahead, a pilot can effectively reduce workload during critical phases of flight. If a pilot enters the final phases of the instrument approach unprepared, the pilot should recognize the situation, abandon the approach, and try it again after becoming better prepared. Effective resource management includes recognizing hazardous situations and attitudes, decision making to promote good judgment and headwork, and managing the situation to ensure the safe outcome of the IFR flight.



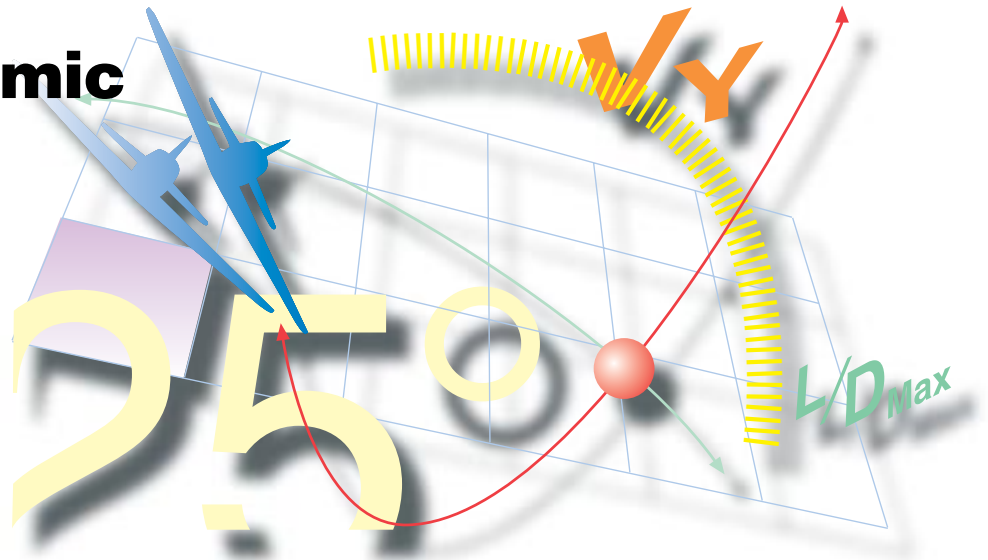
**Figure 1-9.** *The margin of safety.*

### Keys to Communication

**Inquiry**—gather pertinent information.  
**Advocacy**—promote a solution or decision.  
**Assertion**—seek resolution with firm determination.



# Aerodynamic Factors



## Introduction

This chapter outlines the factors affecting aircraft performance as a result of aerodynamics, including a review of basic aerodynamics, the atmosphere, and the effects of icing. Pilots need an understanding of these factors for a sound basis for prediction of aircraft response to control inputs, especially with regard to instrument approaches, while holding, and when operating at reduced airspeed in instrument meteorological conditions (IMC). Although these factors are important to the visual flight rules (VFR) pilot, they must be even more thoroughly understood by the pilot operating under instrument flight rules (IFR). Instrument pilots rely strictly on instrument indications to precisely control the aircraft; therefore, they must have a solid understanding of basic aerodynamic principles in order to make accurate judgments regarding aircraft control inputs.

## Review of Basic Aerodynamics

As an instrument pilot, you must understand the relationship and differences between the aircraft's **flightpath**, **angle of attack**, and pitch attitude. Also, it is crucial to understand how the aircraft will react to various control and power changes because the environment in which instrument pilots fly has inherent hazards not found in visual flying. The basis for this understanding is found in the four forces and Newton's laws.

**Flightpath:** The line, course, or track along which an aircraft is flying or is intended to be flown.

**Angle of attack:** The acute angle formed between the chord line of an airfoil and the direction of the air that strikes the airfoil.

## The Four Forces

The four basic forces acting upon an aircraft in flight are: lift, weight, thrust, and drag. The aerodynamic forces produced by the wing create lift. A byproduct of lift is **induced drag**. Induced drag combined with **parasite drag** (which is the sum of form drag, skin friction, and interference drag) produce the total drag on the aircraft. Thrust must equal total drag in order to maintain speed.

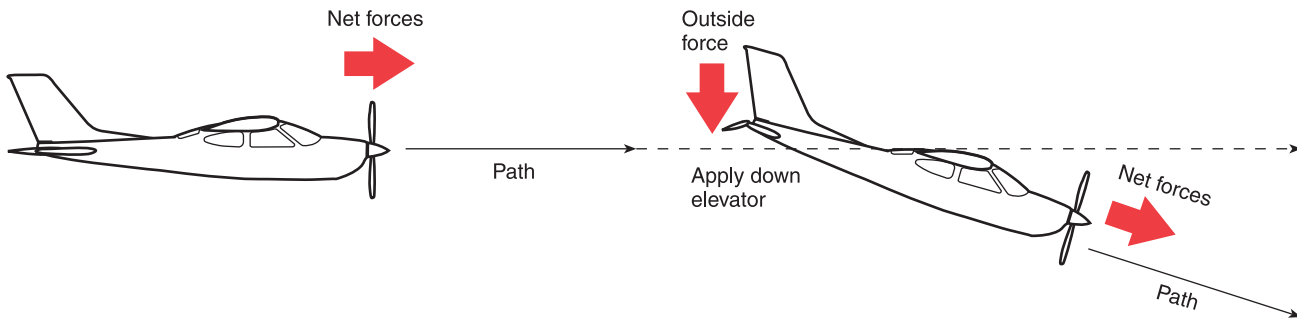
Lift must overcome the total weight of the aircraft, which is comprised of the actual weight of the aircraft plus the tail-down force used to control the aircraft's pitch attitude. Understanding how the aircraft's thrust/drag and lift/weight relationships affect its flightpath and airspeed is essential to proper interpretation of the aircraft's instruments, and to making proper control inputs.

## Newton's First Law

Newton's First Law of Motion is the Law of Inertia, which states that a body in motion will remain in motion, in a straight line, unless acted upon by an outside force. Two outside forces are always present on an aircraft in flight: gravity and drag. Pilots use pitch and thrust controls to counter these forces to maintain the desired flightpath. If a pilot reduces power while in straight-and-level flight, the aircraft will slow. A reduction of lift will cause the aircraft to begin a descent. [Figure 2-1]

**Induced drag:** Caused by the same factors that produce lift, its amount varies inversely with airspeed. As airspeed decreases, the angle of attack must increase, and this increases induced drag.

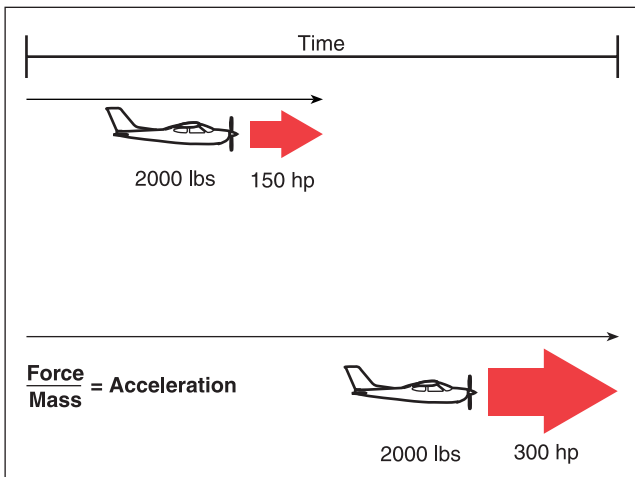
**Parasite drag:** Caused by the friction of air moving over the structure, its amount varies directly with the airspeed. The higher the airspeed, the greater the parasite drag.



**Figure 2-1.** Newton's First Law of Motion: the Law of Inertia.

### Newton's Second Law

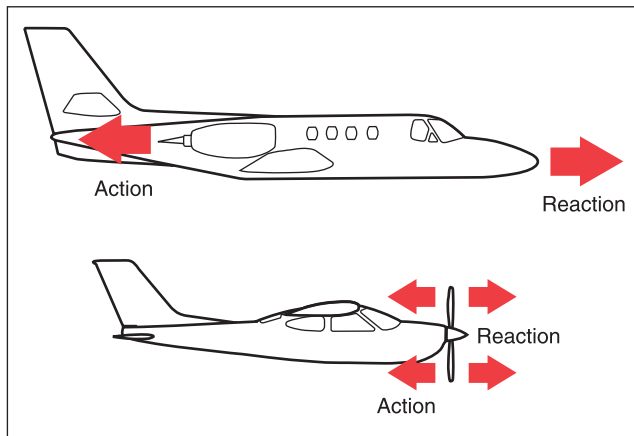
Newton's Second Law of Motion is the Law of Momentum, which states that a body will accelerate in the same direction as the force acting upon that body, and the acceleration will be directly proportional to the net force and inversely proportional to the mass of the body. This law governs the aircraft's ability to change flightpath and speed, which are controlled by attitude (both pitch and bank) and thrust inputs. Speeding up, slowing down, entering climbs or descents, and turning are examples of accelerations that pilots control in everyday flight. [Figure 2-2]



**Figure 2-2.** Newton's Second Law of Motion: the Law of Momentum.

### Newton's Third Law

Newton's Third Law of Motion is the Law of Reaction, which states that for every action there is an equal and opposite reaction. As shown in figure 2-3, the *action* of the jet engine's thrust or the pull of the propeller lead to the *reaction* of the aircraft's forward motion. This law is also responsible for a portion of the lift that is produced by a wing, by the downward deflection of the airflow around it. This downward force of the **relative wind** results in an equal but opposite (upward) lifting force created by the airflow over the wing.



**Figure 2-3.** Newton's Third Law of Motion: the Law of Reaction.

**Relative wind:** The direction from which the wind meets an airfoil.

## Atmosphere

Air density is a result of the relationship between temperature and pressure. This relationship is such that density is inversely related to temperature and directly related to pressure. For a constant pressure to be maintained as temperature increases, density must decrease, and vice versa. For a constant temperature to be maintained as pressure increases, density must increase, and vice versa. These relationships provide a basis for understanding instrument indications and aircraft performance.

### Standard Atmosphere

The International Civil Aviation Organization (ICAO) established the ICAO Standard Atmosphere as a way of creating an international standard for reference and computations. Instrument indications and aircraft performance specifications are derived using this standard as a reference. Because the standard atmosphere is a derived set of conditions that rarely exist in reality, pilots need to understand how deviations from the standard affect both instrument indications and aircraft performance.

In the standard atmosphere, sea level pressure is 29.92" Hg and the temperature is 15 °C (59 °F). The standard lapse rate for pressure is approximately a 1" Hg decrease per 1,000 feet increase in altitude. The standard lapse rate for temperature is a 2 °C (3.6 °F) decrease per 1,000 feet increase, up to the tropopause. Since all aircraft performance is compared and evaluated in the environment of the standard atmosphere, all aircraft performance instrumentation is calibrated for the standard atmosphere. Because the actual operating conditions rarely, if ever, fit the standard atmosphere, certain corrections must apply to the instrumentation and aircraft performance.

### Pressure Altitude

There are two measurements of the atmosphere that pilots must understand: pressure altitude and density altitude. Pressure altitude is the height above the standard datum pressure (29.92" Hg) and is used for standardizing altitudes for **flight levels (FL)** and for calculations involving aircraft performance. If the altimeter is set for 29.92" Hg, the altitude indicated is the pressure altitude.

### Standard Atmosphere

ICAO Standard Atmosphere at sea level is 15 °C and 29.92" Hg. Most small aircraft manuals use this as a reference for their performance charts.

**Flight level (FL):** A measure of altitude used by aircraft flying above 18,000 feet.

### Density Altitude

Density altitude is pressure altitude corrected for nonstandard temperatures, and is used for determining aerodynamic performance in the nonstandard atmosphere. Density altitude increases as the density decreases. Since density varies directly with pressure, and inversely with temperature, a wide range of temperatures may exist with a given pressure altitude, which allows the density to vary. However, a known density occurs for any one temperature and pressure altitude combination. The density of the air has a significant effect on aircraft and engine performance. Regardless of the actual altitude an aircraft is operating, its performance will be as though it were operating at an altitude equal to the existing density altitude.

### Lift

Lift always acts in a direction perpendicular to the relative wind and to the lateral axis of the aircraft. The fact that lift is referenced to the wing, not to the Earth's surface, is the source of many errors in learning flight control. Lift is not always "up." Its direction relative to the Earth's surface changes as you maneuver the aircraft.

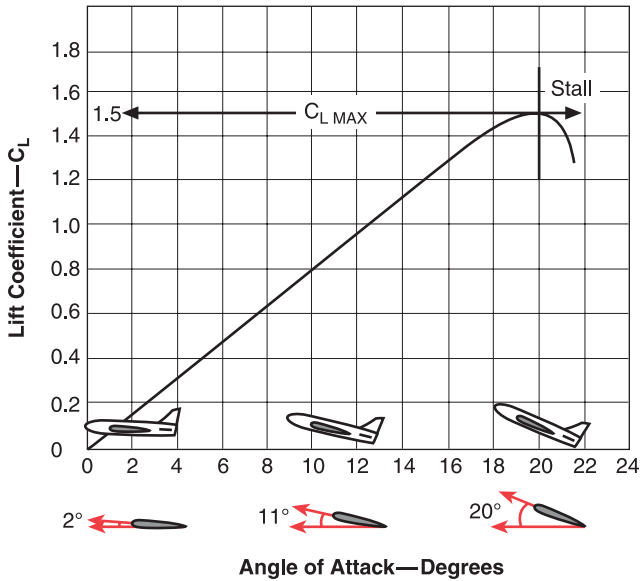
The magnitude of the force of lift is directly proportional to the density of the air, the area of the wings, and the airspeed. It also depends upon the type of wing and the angle of attack. Lift increases with an increase in angle of attack up to the stalling angle, at which point it decreases with any further increase in angle of attack. In conventional aircraft, lift is therefore controlled by varying the angle of attack (attitude) and thrust.

### Pitch/Power Relationship

An examination of figure 2-4 provides insight into the relationship between pitch and power when it comes to controlling flightpath and airspeed. In order to maintain a constant lift, when the airspeed is reduced, the pitch must be increased. The pilot controls pitch through the elevators, which in effect controls the angle of attack. When back pressure is applied on the elevator control, the tail lowers and the nose rises, thus increasing the wing's angle of attack and lift.

### Safety Reminder

As density altitude increases, performance decreases—be aware on hot days at high altitudes.



**Figure 2-4.** Relationship of lift to angle of attack.

Thrust is controlled by using the throttle to establish or maintain desired airspeeds. The most precise method of controlling flightpath is to use pitch control while simultaneously using power (thrust) to control airspeed. In order to maintain a constant lift, a change in pitch will require a change in power, and vice versa.

If you want the aircraft to accelerate while maintaining altitude, thrust must be increased to overcome drag. As the aircraft speeds up, lift is increased. To keep from gaining

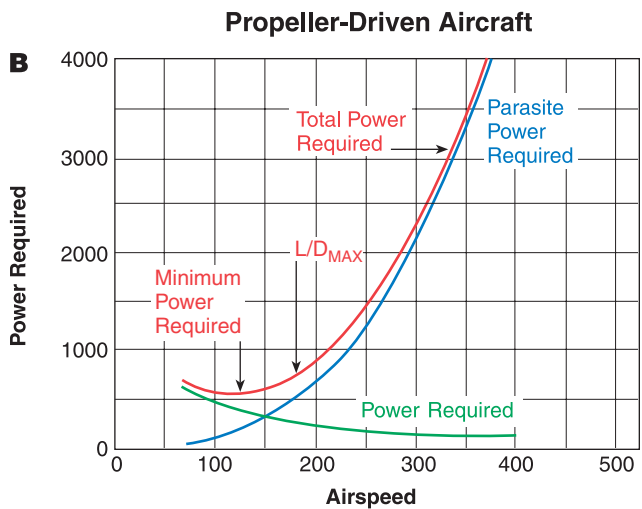
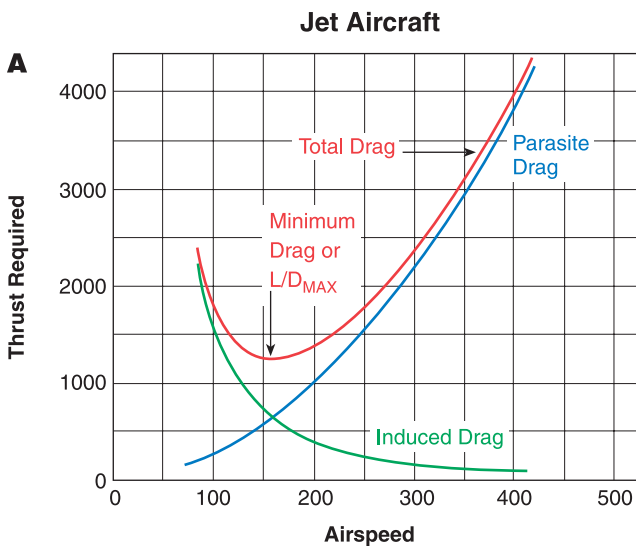
altitude, you must lower the pitch to reduce the angle of attack. If you want the aircraft to decelerate while maintaining altitude, thrust must be decreased. As the aircraft slows down, lift is reduced. Then you must increase the pitch in order to increase the angle of attack and maintain altitude.

## Drag Curves

When induced drag and parasite drag are plotted on a graph, the total drag on the aircraft appears in the form of a “drag curve.” [Figure 2-5] Graph A of figure 2-5 shows a curve based on thrust versus drag, which is primarily used for jet aircraft. Graph B of figure 2-5 is based on power versus drag, and it is used for propeller-driven aircraft. This chapter focuses on power versus drag charts for propeller-driven aircraft.

Understanding the drag curve can provide valuable insight into the various performance parameters and limitations of the aircraft. Because power must equal drag to maintain a steady airspeed, the curve can be either a drag curve or a “power-required curve.” The power-required curve represents the amount of power needed to overcome drag in order to maintain a steady speed in level flight.

The propellers used on most reciprocating engines achieve peak propeller efficiencies in the range of 80 to 88 percent. As airspeed increases, the propeller efficiency will increase until it reaches its maximum. Any airspeed above this maximum point will cause a reduction in propeller efficiency. An engine that produces 160 horsepower will have only about 80 percent of that power converted into available horsepower, approximately 128 horsepower. This is the reason the thrust- and power-available curves change with speed.

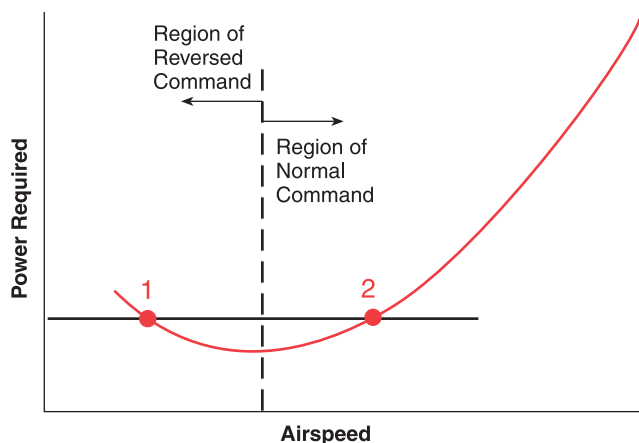


**Figure 2-5.** Thrust and power required curves.

## Regions of Command

The drag curve also illustrates the two **regions of command**: the region of normal command, and the region of reversed command. The term “region of command” refers to the relationship between speed and the power required to maintain or change that speed. “Command” refers to the input the pilot must give in terms of power or thrust to maintain a new speed.

The “region of normal command” occurs where power must be added to increase speed. This region exists at speeds higher than the minimum drag point primarily as a result of parasite drag. The “region of reversed command” occurs where additional power is needed to maintain a slower airspeed. This region exists at speeds slower than the minimum drag point ( $L/D_{MAX}$  on the thrust-required curve, figure 2-5) and is primarily due to induced drag. Figure 2-6 shows how one power setting can yield two speeds, points 1 and 2. This is because at point 1 there is high induced drag and low parasite drag, while at point 2 there is high parasite drag and low induced drag.



**Figure 2-6.** *Regions of command.*

### Control Characteristics

Most flying is conducted in the region of normal command: for example, cruise, climb, and maneuvers. The region of reversed command may be encountered in the slow-speed phases of flight during takeoff and landing; however, for most

**Regions of command:** The relationship between speed and the power required to maintain or change that speed in flight.

**Static longitudinal stability:** The aerodynamic pitching moments required to return the aircraft to the equilibrium angle of attack.

general aviation aircraft, this region is very small and is below normal approach speeds.

Flight in the region of normal command is characterized by a relatively strong tendency of the aircraft to maintain the trim speed. Flight in the region of reversed command is characterized by a relatively weak tendency of the aircraft to maintain the trim speed. In fact, it is likely the aircraft will exhibit no inherent tendency to maintain the trim speed in this area. For this reason, you must give particular attention to precise control of airspeed when operating in the slow-speed phases of the region of reversed command.

Operation in the region of reversed command does not imply that great control difficulty and dangerous conditions will exist. However, it does amplify errors of basic flying technique—making proper flying technique and precise control of the aircraft very important.

## Speed Stability

### Normal Command

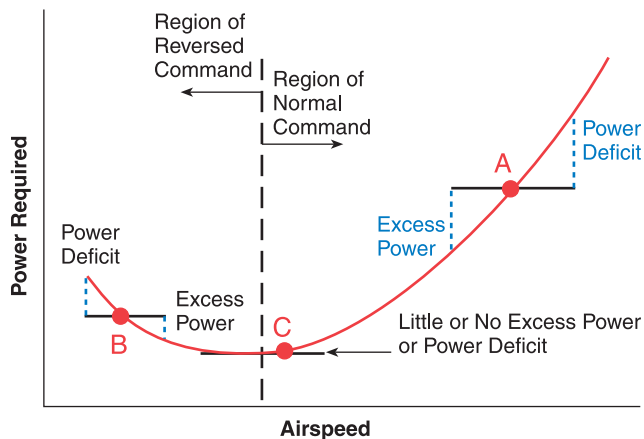
The characteristics of flight in the region of normal command are illustrated at point A on the curve in figure 2-7. If the aircraft is established in steady, level flight at point A, lift is equal to weight, and the power available is set equal to the power required. If the airspeed is increased with no changes to the power setting, a power deficiency exists. The aircraft will have the natural tendency to return to the initial speed to balance power and drag. If the airspeed is reduced with no changes to the power setting, an excess of power exists. The aircraft will have the natural tendency to speed up to regain the balance between power and drag. Keeping the aircraft in proper trim enhances this natural tendency. The **static longitudinal stability** of the aircraft tends to return the aircraft to the original trimmed condition.

An aircraft flying in steady, level flight at point C is in equilibrium. [Figure 2-7] If the speed were increased or decreased slightly, the aircraft would tend to remain at that speed. This is because the curve is relatively flat and a slight change in speed will not produce any significant excess or deficiency in power. It has the characteristic of neutral stability; the aircraft’s tendency is to remain at the new speed.

### Slow Airspeed Safety Hint

**Be sure to add power before pitching up while at slow airspeeds to prevent losing airspeed.**





**Figure 2-7.** Regions of speed stability.

### Reversed Command

The characteristics of flight in the region of reversed command are illustrated at point B on the curve in figure 2-7. If the aircraft is established in steady, level flight at point B, lift is equal to weight, and the power available is set equal to the power required. When the airspeed is increased greater than point B, an excess of power exists. This causes the aircraft to accelerate to an even higher speed. When the aircraft is slowed to some airspeed lower than point B, a deficiency of power exists. The natural tendency of the aircraft is to continue to slow to an even lower airspeed.

This tendency toward instability happens because the variation of excess power to either side of point B magnifies the original change in speed. Although the static longitudinal stability of the aircraft tries to maintain the original trimmed condition, this instability is more of an influence because of the increased induced drag due to the higher angles of attack in slow-speed flight.

### Trim

A trim tab is a small, adjustable hinged surface, located on the trailing edge of the aileron, rudder, or elevator control surface. It is used to maintain balance in straight-and-level flight and during other prolonged flight conditions so the pilot does not have to hold pressure on the controls. This is accomplished by deflecting the tab in the direction opposite to that in which the primary control surface must be held.

### Reversed Logic

In the region of reversed command, as you slow down you require more power.

The force of the airflow striking the tab causes the main control surface to be deflected to a position that will correct the unbalanced condition of the aircraft.

Because the trim tabs use airflow to function, trim is a function of speed. Any change in speed will result in the need to retrim the aircraft. A properly trimmed aircraft seeks to return to the original speed before the change. Therefore, it is very important for instrument pilots to keep the aircraft in constant trim. This will reduce the workload significantly and allow pilots to tend to other duties without compromising aircraft control.

### Slow-Speed Flight

Anytime you are flying near the stalling speed or the region of reversed command, such as in final approach for a normal landing, the initial part of a go-around, or maneuvering in slow flight, you are operating in what is called slow-speed flight. It is characterized by high angles of attack and in many cases, the need for flaps or other high-lift devices.

### Small Airplanes

Most small airplanes maintain a speed well in excess of 1.3 times  $V_{SO}$  on an instrument approach. An airplane with a stall speed of 50 knots ( $V_{SO}$ ) has a normal approach speed of 65 knots. However, this same airplane may maintain 90 knots ( $1.8 V_{SO}$ ) while on the final segment of an instrument approach. The landing gear will most likely be extended at the beginning of the descent to the minimum descent altitude, or upon intercepting the glide slope of the instrument landing system. The pilot may also select an intermediate flap setting for this phase of the approach. The airplane at this speed will have good positive speed stability, as represented by point A on figure 2-7. Flying at this point, you can make slight pitch changes without changing power settings, and accept minor speed changes knowing that when the pitch is returned to the initial setting, the speed will return to the original setting. This reduces your workload.

You would usually slow down to a normal landing speed when on a relatively short final. When you slow the airplane to 65 knots,  $1.3 V_{SO}$ , the airplane will be close to point C. [Figure 2-7] At this point, precise control of the pitch and power becomes more crucial for maintaining the correct speed. Pitch and power coordination is necessary because

the speed stability is relatively neutral—the speed tends to remain at the new value and not return to the original setting. In addition to the need for more precise airspeed control, you would normally change the aircraft’s configuration by adding landing flaps. This configuration change means you must guard against unwanted pitch changes at a low altitude.

If you allow the speed to slow several knots, the airplane could enter the region of reversed command. At this point, the airplane could develop an unsafe sink rate and continue to lose speed if you do not take prompt, corrective action. Proper pitch and power coordination is critical in this region due to speed instability and the tendency of increased divergence from the desired speed.

### Large Airplanes

Pilots of larger airplanes with higher stall speeds may find the speed they maintain on the instrument approach is near  $1.3 V_{SO}$ , putting them near point C (in figure 2-7) the entire time the airplane is on the final approach segment. In this case, precise speed control is necessary throughout the approach. It may be necessary to overpower or underpower in relation to the target power setting in order to quickly correct for airspeed deviations.

For example, a pilot is on an instrument approach at  $1.3 V_{SO}$ , a speed near  $L/D_{MAX}$ , and knows that a certain power setting will maintain that speed. The airplane slows several knots below the desired speed because of a slight reduction in the power setting. The pilot increases the power slightly, and the airplane begins to accelerate, but at a slow rate. Because the airplane is still in the “flat part” of the drag curve, this slight increase in power will not cause a rapid return to the desired speed. The pilot may need to increase the power higher than normally needed to maintain the new speed, allow the airplane to accelerate, then reduce the power to the setting that will maintain the desired speed.

### Climbs

The ability for an aircraft to climb depends upon an excess power or thrust over what it takes to maintain equilibrium. Excess power is the available power over and above that required to maintain horizontal flight at a given speed. Although the terms power and thrust are sometimes used interchangeably (erroneously implying they are synony-

mous), distinguishing between the two is important when considering climb performance. **Work** is the product of a force moving through a distance and is usually independent of time. **Power** implies work rate or units of work per unit of time, and as such is a function of the speed at which the force is developed. **Thrust** also a function of work, means the force which imparts a change in the velocity of a mass.

For a given weight of the aircraft, the angle of climb depends on the difference between thrust and drag, or the excess thrust. When the excess thrust is zero, the inclination of the flightpath is zero, and the aircraft will be in steady, level flight. When thrust is greater than drag, the excess thrust will allow a climb angle depending on the amount of excess thrust. When thrust is less than drag, the deficiency of thrust will induce an angle of descent.

### Acceleration in Cruise Flight

Aircraft accelerate in level flight because of an excess of power over what is required to maintain a steady speed. This is the same excess power used to climb. When you reach the desired altitude and lower the pitch to maintain that altitude, the excess power can now accelerate the aircraft to its cruise speed. Reducing power too soon after level-off will result in a longer period of time to accelerate.

### Turns

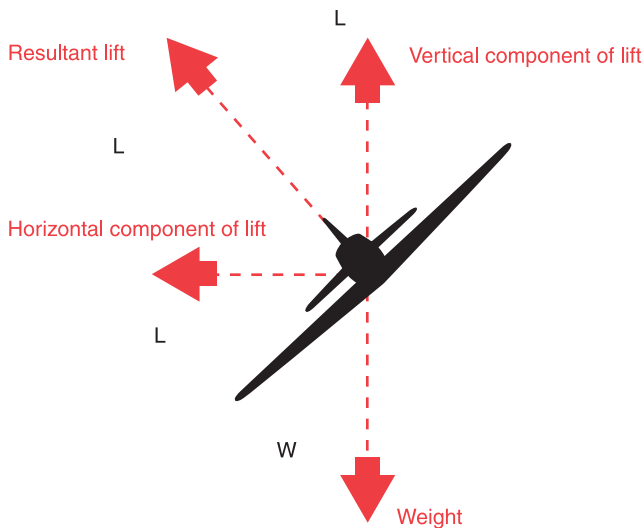
Like any moving object, an aircraft requires a sideward force to make it turn. In a normal turn, this force is supplied by banking the aircraft in order to exert lift inward as well as upward. The force of lift is separated into two components at right angles to each other. [Figure 2-8] The upward-acting lift and the opposing weight together become the vertical lift component. The horizontally-acting lift and its opposing centrifugal force are the horizontal lift component, or centripetal force. This horizontal lift component is the sideward force that causes an aircraft to turn. The equal and opposite reaction to this sideward force is centrifugal force, which is merely an apparent force as a result of inertia.

The relationship between the aircraft’s speed and bank angle to the rate and radius of turns is important for instrument pilots to understand. You can use this knowledge to properly estimate bank angles needed for certain rates of turn, or for figuring how much to lead when intercepting a course.

**Work:** A physical measurement of force used to produce movement.

**Power (mechanical):** Work done in a period of time.

**Thrust (aerodynamic force):** The forward aerodynamic force produced by a propeller, fan, or turbojet engine as it forces a mass of air to the rear, behind the aircraft.



**Figure 2-8.** Forces in a turn.

### Rate of Turn

The rate of turn, normally measured in degrees per second, is based upon a set bank angle at a set speed. If either one of these elements changes, then the rate of turn will change. If the aircraft increases its speed without changing the bank angle, then the rate of turn will decrease. Likewise, if the speed decreases without changing the bank angle, the rate of turn will increase.

Changing the bank angle without changing speed will also cause the rate of turn to change. Increasing the bank angle without changing speed will increase the rate of turn, while decreasing the bank angle will reduce the rate of turn.

The standard rate of turn, 3° per second, is used as the main reference for bank angle. Therefore, you must understand how the angle of bank will vary with speed changes, such as slowing down for holding or an instrument approach. Figure 2-9 shows the turn relationship with reference to a constant bank angle or a constant airspeed, and the effects on rate of turn and radius of turn.

### Radius of Turn

The radius of turn will vary with changes in either speed or bank. If the speed is increased without changing the bank angle, the radius of turn will increase, and vice versa. If the

speed is constant, increasing the bank angle will reduce the radius of turn, while decreasing the bank angle will increase the radius of turn. This means that intercepting a course at a higher speed will require more distance, and therefore, require a longer lead. If the speed is slowed considerably in preparation for holding or an approach, a shorter lead is needed than that required for cruise flight.

### Coordination of Rudder and Aileron Controls

Anytime ailerons are used, **adverse yaw** is produced. This yaw causes the nose of the aircraft to initially move in the direction opposite of the turn. Correcting for this yaw with rudder, when entering and exiting turns is necessary for precise control of the airplane when flying on instruments. You can tell if the turn is coordinated by checking the ball in the turn-and-slip indicator or the turn coordinator.

As you bank the wings to enter the turn, a portion of the wing's vertical lift becomes the horizontal component; therefore, without an increase in back pressure, the aircraft will lose altitude during the turn. The loss of vertical lift can be offset by increasing the pitch in one-half bar width increments. Trim may be used to relieve the control pressures; however, if used, it will have to be removed once the turn is complete.

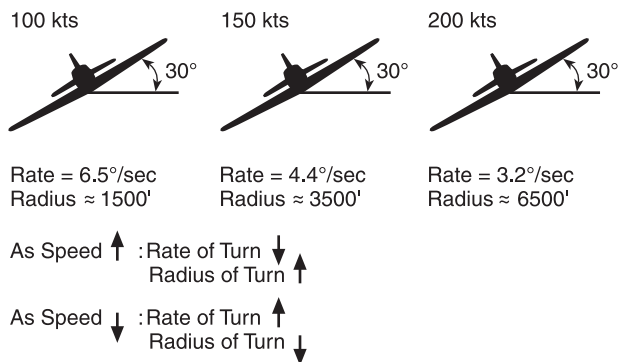
In a slipping turn, the aircraft is not turning at the rate appropriate to the bank being used, and the aircraft falls to the inside of the turn. The aircraft is banked too much for the rate of turn, so the horizontal lift component is greater than the centrifugal force. A skidding turn results from excess of centrifugal force over the horizontal lift component, pulling the aircraft toward the outside of the turn. The rate of turn is too great for the angle of bank, so the horizontal lift component is less than the centrifugal force.

The ball instrument indicates the quality of the turn, and should be centered when the wings are banked. If the ball is out of its **cage** on the side toward the turn, the aircraft is slipping and you should add rudder pressure on that side to increase the rate of turn, and adjust the bank angle as required. If the ball is out of its cage on the side away from the turn, the aircraft is skidding and rudder pressure toward the turn should be relaxed or the bank angle increased. If the aircraft is properly rigged, the ball should be in the center when the wings are level; use rudder and/or aileron trim if available.

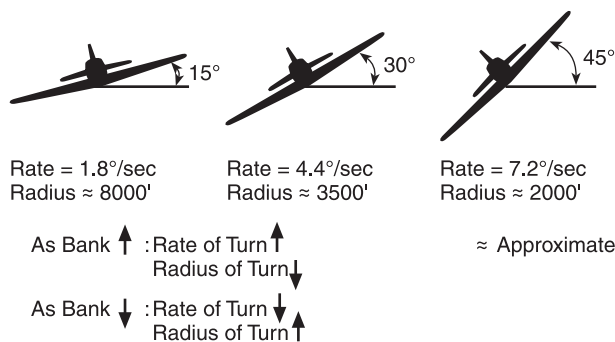
**Adverse yaw:** A flight condition at the beginning of a turn in which the nose of the aircraft starts to move in the direction opposite the direction the turn is being made.

**Cage:** The black markings on the ball instrument indicating its neutral position.

### Constant 30° Bank Angle



### Constant Speed of 150 Knots



**Figure 2-9. Turns.**

The increase in induced drag (caused by the increase in angle of attack necessary to maintain altitude) will result in a minor loss of airspeed if the power setting is not changed. Accept this loss of airspeed—an attempt to maintain airspeed may divert your attention at a critical time.

## Load Factor

Any force applied to an aircraft to deflect its flight from a straight line produces a stress on its structure; the amount of this force is termed **load factor**. A load factor is the ratio of the aerodynamic force on the aircraft to the gross weight of the aircraft (e.g., lift/weight). For example, a load factor of 3 means the total load on an aircraft’s structure is three times its gross weight. When designing an aircraft, it is necessary to determine the highest load factors that can be expected in normal operation under various operational situations. These “highest” load factors are called “limit load factors.”

Aircraft are placed in various categories, i.e., normal, utility, and acrobatic, depending upon the load factors they are designed to take. For reasons of safety, the aircraft must be designed to withstand certain maximum load factors without any structural damage.

The specified load may be expected in terms of aerodynamic forces, as in turns. In level flight in undisturbed air, the wings are supporting not only the weight of the aircraft, but centrifugal force as well. As the bank steepens, the horizontal

lift component increases, centrifugal force increases, and the load factor increases. If the load factor becomes so great that an increase in angle of attack cannot provide enough lift to support the load, the wing stalls. Since the stalling speed increases directly with the square root of the load factor, you should be aware of the flight conditions during which the load factor can become critical. Steep turns at slow airspeed, structural ice accumulation, and vertical gusts in turbulent air can increase the load factor to a critical level.

## Effects of Icing

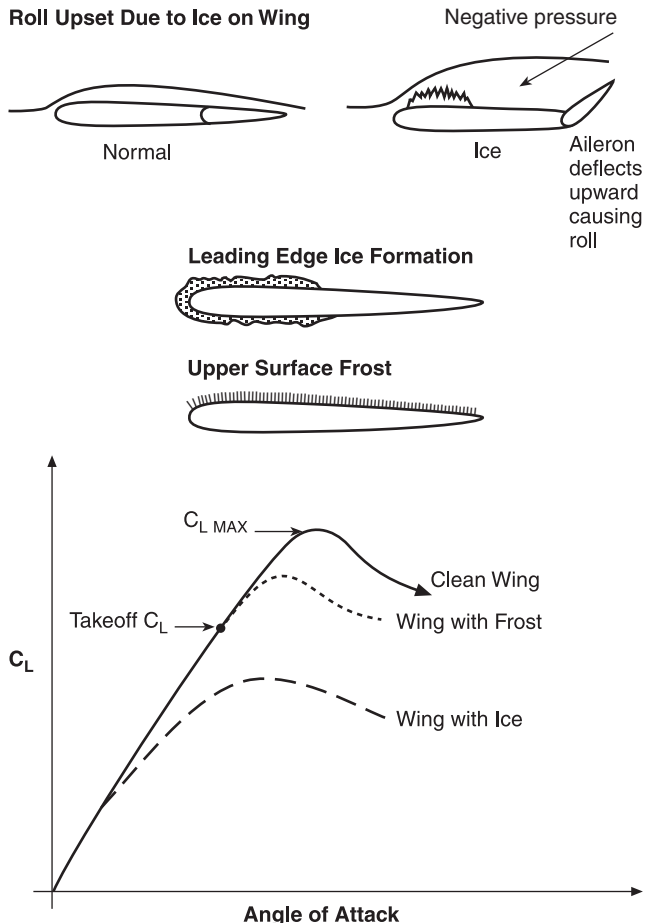
One of the hazards to flight is aircraft icing. Pilots should be aware of the conditions conducive to icing, the types of icing, the effects of icing on aircraft control and performance, and the use and limitations of aircraft deice and anti-ice equipment.

Structural icing refers to the accumulation of ice on the exterior of the aircraft; induction icing affects the powerplant operation. Significant structural icing on an aircraft can cause aircraft control and performance problems. To reduce the probability of ice buildup on the unprotected areas of the aircraft, you should maintain at least the minimum airspeed for flight in sustained icing conditions. This airspeed will be listed in the Pilot’s Operating Handbook/Airplane Flight Manual (POH/AFM).

**Load factor:** Lift to weight ratio.

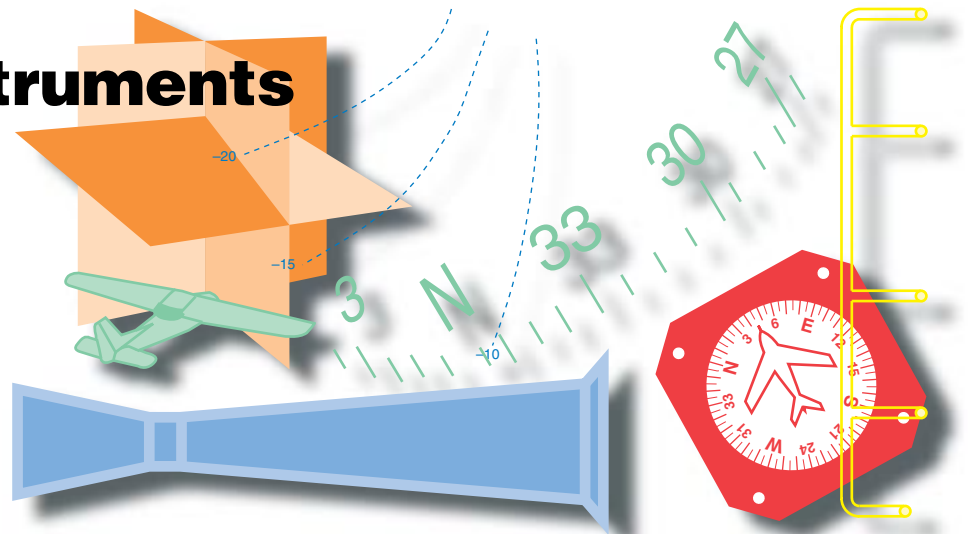
The most hazardous aspect of structural icing is its aerodynamic effects. [Figure 2-10] Ice can alter the shape of an airfoil, which can cause control problems, change the angle of attack at which the aircraft stalls, and cause the aircraft to stall at a significantly higher airspeed. Ice can reduce the amount of lift an airfoil will produce and greatly increase drag. It can partially block or limit control surfaces which will limit or make control movements ineffective. Also, if the extra weight caused by ice accumulation is too great, the aircraft may not be able to become airborne and, if in flight, the aircraft may not be able to maintain altitude. Any accumulation of ice or frost should be removed before attempting flight.

Another hazard of structural icing is the possible uncommanded and uncontrolled roll phenomenon, referred to as roll upset, associated with severe in-flight icing. Pilots flying aircraft certificated for flight in known icing conditions should be aware that severe icing is a condition outside of the aircraft's certification icing envelope. Roll upset may be caused by airflow separation (aerodynamic stall) which induces self-deflection of the ailerons and loss of or degraded roll-handling characteristics. These phenomena can result from severe icing conditions without the usual symptoms of ice accumulation or a perceived aerodynamic stall.



**Figure 2-10.** Effect of ice and frost on lift.

# Flight Instruments



## Introduction

Aircraft became a practical means of transportation when accurate flight instruments freed the pilot from the necessity of maintaining visual contact with the ground. Safety was enhanced when all pilots with private or higher ratings were required to demonstrate their ability to maintain level flight and make safe turns without reference to the outside horizon.

The basic flight instruments required for operation under visual flight rules (VFR) are an airspeed indicator, an altimeter, and a magnetic direction indicator. In addition to these, operation under instrument flight rules (IFR) requires a gyroscopic rate-of-turn indicator, a slip-skid indicator, a sensitive altimeter adjustable for barometric pressure, a clock displaying hours, minutes, and seconds with a sweep-second pointer or digital presentation, a gyroscopic pitch-and-bank indicator (artificial horizon), and a gyroscopic direction indicator (directional gyro or equivalent).

Aircraft that are flown in instrument meteorological conditions (IMC) are equipped with instruments that provide attitude and direction reference, as well as radio navigation instruments that allow precision flight from takeoff to landing with limited or no outside visual reference.

The instruments discussed in this chapter are those required by Title 14 of the Code of Federal Regulations (14 CFR) part 91, and are organized into three groups: pitot-static instruments, compass systems, and gyroscopic instruments. The chapter concludes with a discussion of how to preflight these systems for IFR flight.

## Pitot-Static Systems

Three basic pressure-operated instruments are found in most aircraft instrument panels. These are the sensitive altimeter, airspeed indicator (ASI), and vertical speed indicator (VSI). All three receive the pressures they measure from the aircraft pitot-static system.

Flight instruments depend upon accurate sampling of the ambient atmospheric pressure to determine the height and speed of movement of the aircraft through the air, both horizontally and vertically. This pressure is sampled at two or more locations outside the aircraft by the pitot-static system.

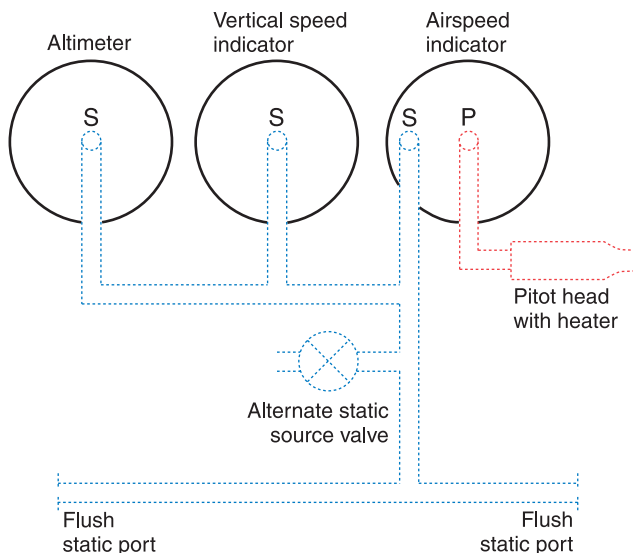
The pressure of the static, or still air, is measured at a flush port where the air is not disturbed. On some aircraft, this air is sampled by static ports on the side of the electrically heated **pitot-static head**, such as the one in figure 3-1. Other aircraft pick up the **static pressure** through flush ports on the side of

**Pitot-static head:** A combination pickup used to sample pitot pressure and static air pressure.

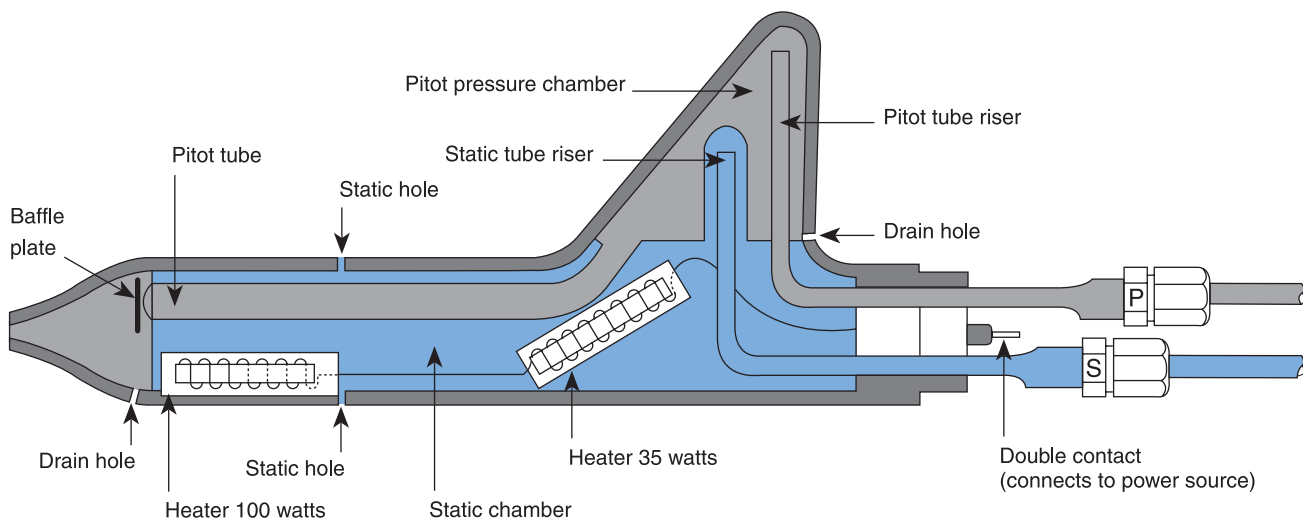
**Static pressure:** Pressure of the air that is still, or not moving, measured perpendicular to the surface of the aircraft.

the fuselage or the vertical fin. These ports are in locations proven by flight tests to be in undisturbed air, and they are normally paired, one on either side of the aircraft. This dual location prevents lateral movement of the aircraft from giving erroneous static pressure indications. The areas around the static ports may be heated with electric heater elements to prevent ice forming over the port and blocking the entry of the static air.

**Pitot pressure**, or impact air pressure, is taken in through an open-end tube pointed directly into the relative wind flowing around the aircraft. The pitot tube connects to the airspeed indicator, and the static ports deliver their pressure to the airspeed indicator, altimeter, and VSI. If the static ports should ice over, or in any other way become obstructed, the pilot is able to open a static-system alternate source valve to provide a static air pressure source from a location inside the aircraft. [Figure 3-2] This may cause an inaccurate indication on the pitot-static instrument. Consult the Pilot's Operating Handbook/Airplane Flight Manual (POH/AFM) to determine the amount of error.



**Figure 3-2.** A typical pitot-static system.



**Figure 3-1.** A typical electrically heated pitot-static head.

**Pitot pressure:** Ram air pressure used to measure airspeed.

## Position Error

The static ports are located in a position where the air at their surface is as undisturbed as possible. But under some flight conditions, particularly at a high angle of attack with the landing gear and flaps down, the air around the static port may be disturbed to the extent that it can cause an error in the indication of the altimeter and airspeed indicator. Because of the importance of accuracy in these instruments, part of the certification tests for an aircraft is a check of **position error** in the static system.

The POH/AFM contains any corrections that must be applied to the airspeed for the various configurations of flaps and landing gear.

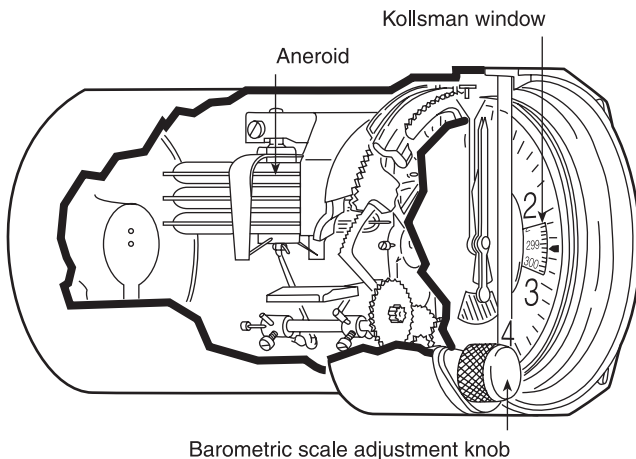
## Pitot-Static Instruments

### Sensitive Altimeter

A sensitive altimeter is an aneroid barometer that measures the absolute pressure of the ambient air and displays it in terms of feet or meters above a selected pressure level.

#### Principle of Operation

The sensitive element in a sensitive altimeter is a stack of evacuated, corrugated bronze aneroid capsules like those shown in figure 3-3. The air pressure acting on these aneroids tries to compress them against their natural springiness, which tries to expand them. The result is that their thickness changes as the air pressure changes. Stacking several aneroids increases the dimension change as the pressure varies over the usable range of the instrument.



**Figure 3-3.** Sensitive altimeter components.

**Position error:** Error in the indication of the altimeter, ASI, and VSI caused by the air at the static system entrance not being absolutely still.

Below 10,000 feet, a striped segment is visible. Above this altitude, a mask begins to cover it, and above 15,000 feet, all of the stripes are covered. [Figure 3-4]

Another configuration of the altimeter is the drum-type, like the one in figure 3-5. These instruments have only one pointer that makes one revolution for every 1,000 feet. Each number represents 100 feet, and each mark represents 20 feet. A drum, marked in thousands of feet, is geared to the mechanism that drives the pointer. To read this type of altimeter, first look at the drum to get the thousands of feet, and then at the pointer to get the feet and hundreds of feet.



**Figure 3-4.** Three-pointer altimeter.



**Figure 3-5.** Drum-type altimeter.



A sensitive altimeter is one with an adjustable barometric scale that allows you to set the reference pressure from which the altitude is measured. This scale is visible in a small window, called the **Kollsman window**. The scale is adjusted by a knob on the instrument. The range of the scale is from 28.00 to 31.00" Hg, or 948 to 1,050 millibars.

Rotating the knob changes both the barometric scale and the altimeter pointers in such a way that a change in the barometric scale of 1" Hg changes the pointer indication by 1,000 feet. This is the standard pressure lapse rate below 5,000 feet. When the barometric scale is adjusted to 29.92" Hg, or 1,013.2 millibars, the pointers indicate the pressure altitude. When you wish to display indicated altitude, adjust the barometric scale to the local altimeter setting. The instrument then indicates the height above the existing sea level pressure.

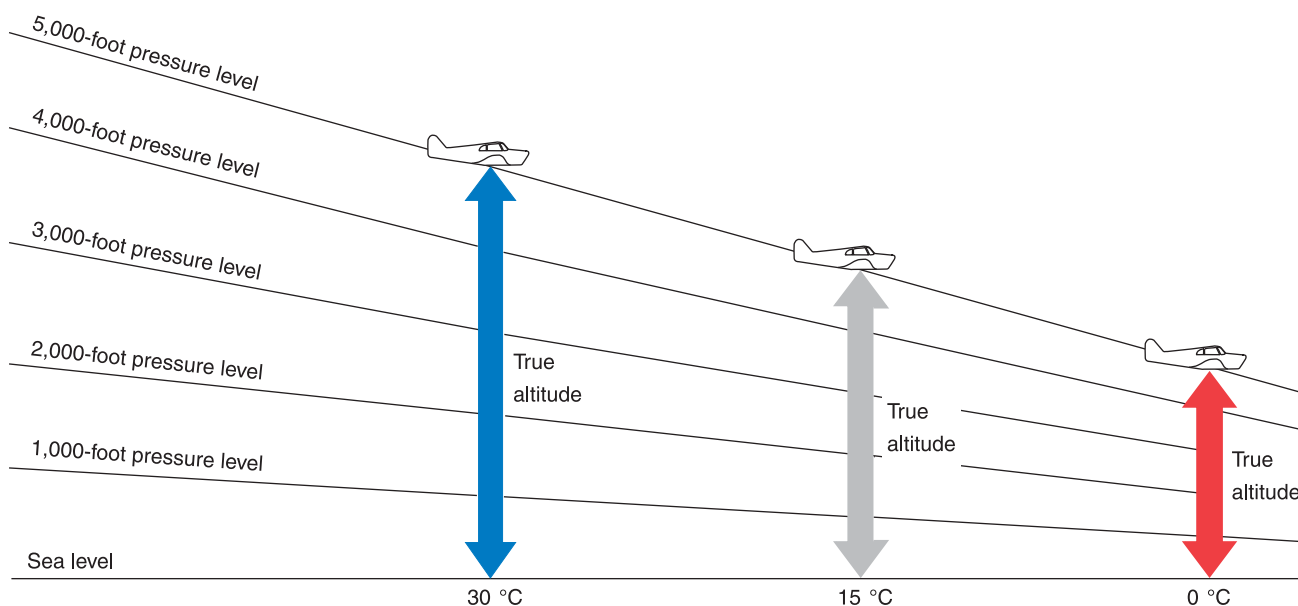
### Altimeter Errors

A sensitive altimeter is designed to indicate standard changes from standard conditions, but most flying involves errors caused by nonstandard conditions, and you must be able to modify the indications to correct for these errors. There are two types of errors: mechanical and inherent.

A preflight check to determine the condition of an altimeter consists of setting the barometric scale to the altimeter setting transmitted by the local automated flight service station (AFSS). The altimeter pointers should indicate the surveyed elevation of the airport. If the indication is off more than 75 feet from the surveyed elevation, the instrument should be referred to a certificated instrument repair station for recalibration. Differences between ambient temperature and/or pressure will cause an erroneous indication on the altimeter.

Figure 3-6 shows the way nonstandard temperature affects an altimeter. When the aircraft is flying in air that is warmer than standard, the air is less dense and the pressure levels are farther apart. When the aircraft is flying at an indicated altitude of 5,000 feet, the pressure level for that altitude is higher than it would be in air at standard temperature, and the aircraft will be higher than it would be if the air were cooler.

If the air is colder than standard, it is denser, and the pressure levels are closer together. When the aircraft is flying at an indicated altitude of 5,000 feet, its true altitude is lower than it would be if the air were warmer.



**Figure 3-6.** Effects of nonstandard temperature on an altimeter.

**Kollsman window:** A barometric scale window of a sensitive altimeter.

## ICAO Cold Temperature Error Table

The cold temperature induced altimeter error may be significant when considering obstacle clearances when temperatures are well below standard. Pilots may wish to increase their minimum terrain clearance altitudes with a corresponding increase in ceiling from the normal minimum when flying in extreme cold temperature conditions. Higher altitudes may need to be selected when flying at low terrain clearances. Some flight management systems (FMS) with air data computers may implement a capability to compensate for cold temperature errors. Pilots flying with these systems should ensure they are aware of the conditions under which the system will automatically compensate. If compensation is applied by the FMS or manually, ATC must be informed that the aircraft is not flying the assigned altitude. Otherwise, vertical separation from other aircraft may be reduced creating a potentially hazardous situation. The following table, derived from ICAO standard formulas, shows how much error can exist when the temperature is extremely cold. To use the table, find the reported temperature in the left column, then read across the top row to the height above the airport/reporting station (e.g.: subtract the airport elevation from the altitude of the final approach fix). The intersection of the column and row is the amount of possible error.

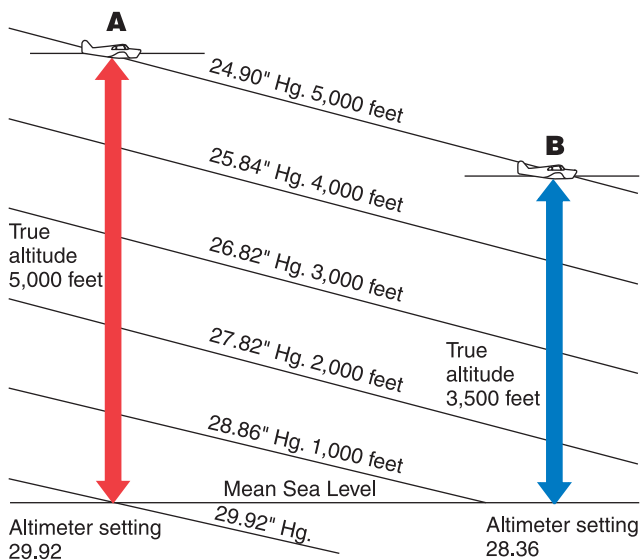
Example:  $-10^{\circ}$  Celsius and the FAF is 500 feet above the airport elevation. The reported current altimeter setting may place the aircraft as much as 50 feet below the altitude indicated by the altimeter.

		Height above Airport in Feet													
		200	300	400	500	600	700	800	900	1000	1500	2000	3000	4000	5000
Reported Temp C°	+10	10	10	10	10	20	20	20	20	20	30	40	60	80	90
	0	20	20	30	30	40	40	50	50	60	90	120	170	230	280
	-10	20	30	40	50	60	70	80	90	100	150	200	290	390	490
	-20	30	50	60	70	90	100	120	130	140	210	280	420	570	710
	-30	40	60	80	100	120	130	150	170	190	280	380	570	760	950
	-40	50	80	100	120	150	170	190	220	240	360	480	720	970	1210
	-50	60	90	120	150	180	210	240	270	300	450	590	890	1190	1500

**Figure 3-7.** Cold temperature corrections chart.

Extreme differences between ambient and standard temperature must be taken into consideration to prevent controlled flight into terrain (CFIT). [Figure 3-7]

Any time the barometric pressure lapse rate differs from the standard of 1" Hg per thousand feet in the lower elevations, the indicated altitude will be different from the true altitude. For example, figure 3-8 shows an airplane at point A flying in air in which conditions are standard — the altimeter setting is 29.92" Hg. When the altimeter indicates 5,000 feet, the true altitude is also 5,000 feet.



**Figure 3-8.** Effects of nonstandard pressure on an altimeter.

The airplane then flies to point B, where the pressure is lower than standard, and the altimeter setting is 28.36" Hg, but the pilot does not change the altimeter to this new altimeter setting. When the altimeter shows an indicated altitude of 5,000 feet, the true altitude, or the height above mean sea level, is only 3,500 feet.

The fact that the altitude indication is not always true lends itself to the memory aid, "When flying from hot to cold, or from a high to a low, look out below."

**Memory Aid:**

When flying from hot to cold, or from a high to a low, look out below!

**Encoding Altimeter**

It is not sufficient in the airspace system for only the pilot to have an indication of the aircraft's altitude; the air traffic controller on the ground must also know the altitude of the aircraft. To provide this information, the aircraft may be equipped with an encoding altimeter.

When the ATC **transponder** is set to Mode C, the **encoding altimeter** supplies the transponder with a series of pulses identifying the flight level (in increments of 100 feet) at which the aircraft is flying. This series of pulses is transmitted to the ground radar where they appear on the controller's scope as an alphanumeric display around the return for the aircraft. The transponder allows the ground controller to identify the aircraft under his/her control and to know the pressure altitude at which each is flying.

A computer inside the encoding altimeter measures the pressure referenced from 29.92" Hg and delivers this data to the transponder. When the pilot adjusts the barometric scale to the local altimeter setting, the data sent to the transponder is not affected. 14 CFR part 91 requires the altitude transmitted by the transponder to be within 125 feet of the altitude indicated on the instrument used to maintain flight altitude.

**Absolute Altimeter**

The absolute altimeter, also called a radar or radio altimeter, measures the height of the aircraft above the terrain. It does this by transmitting a radio signal, either a frequency-modulated continuous-wave or a pulse to the ground, and accurately measuring the time used by the signal in traveling from the aircraft to the ground and returning. This transit time is modified with a time delay and is converted inside the indicator to distance in feet.

Most absolute altimeters have a provision for setting a decision height/decision altitude (DH/DA) or a minimum descent altitude (MDA) so that when the aircraft reaches this height above ground, a light will illuminate and/or an aural warning will sound. Absolute altimeters are incorporated into ground proximity warning systems (GPWS) and into some flight directors.

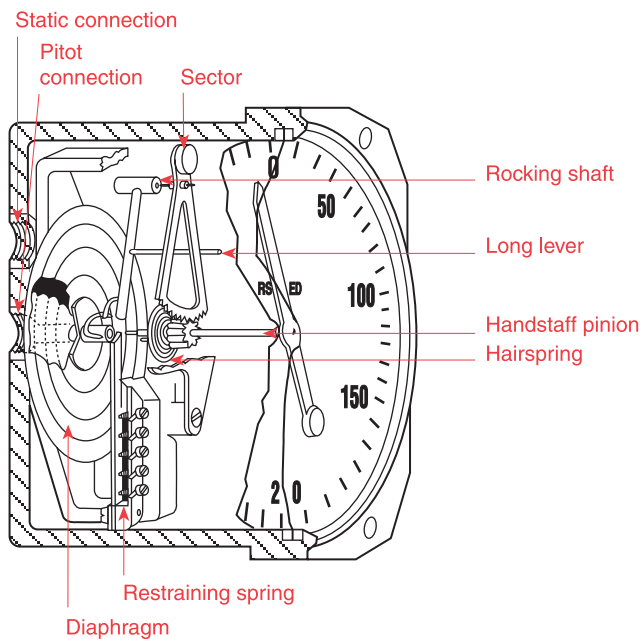
**Transponder:** The airborne portion of the ATC radar beacon system.

**Encoding altimeter:** A sensitive altimeter that sends signals to the ATC transponder, showing the pressure altitude the aircraft is flying.

## Airspeed Indicators

An airspeed indicator is a differential pressure gauge that measures the dynamic pressure of the air through which the aircraft is flying. Dynamic pressure is the difference in the ambient static air pressure and the total, or ram, pressure caused by the motion of the aircraft through the air. These two pressures are taken from the pitot-static system.

The mechanism of the airspeed indicator in figure 3-9 consists of a thin, corrugated phosphor-bronze aneroid, or diaphragm, that receives its pressure from the pitot tube. The instrument case is sealed and connected to the static ports. As the pitot pressure increases, or the static pressure decreases, the diaphragm expands, and this dimensional change is measured by a rocking shaft and a set of gears that drives a pointer across the instrument dial. Most airspeed indicators are calibrated in knots, or nautical miles per hour; some instruments show statute miles per hour, and some instruments show both.



**Figure 3-9.** Mechanism of an airspeed indicator.

### Types of Airspeed

Just as there are many types of altitude, there are many types of airspeed: indicated airspeed (IAS), calibrated airspeed (CAS), equivalent airspeed (EAS), and true airspeed (TAS).

#### Indicated Airspeed

Indicated airspeed is shown on the dial of the instrument, uncorrected for instrument or system errors.

#### Calibrated Airspeed

Calibrated airspeed is the speed the aircraft is moving through the air, which is found by correcting IAS for instrument and position errors. The POH/AFM has a chart or graph to correct IAS for these errors and provide the correct CAS for the various flap and landing gear configurations.

#### Equivalent Airspeed

Equivalent airspeed is CAS corrected for compression of the air inside the pitot tube. Equivalent airspeed is the same as CAS in standard atmosphere at sea level. As the airspeed and pressure altitude increase, the CAS becomes higher than it should be and a correction for compression must be subtracted from the CAS.

#### True Airspeed

True airspeed is CAS corrected for nonstandard pressure and temperature. True airspeed and CAS are the same in standard atmosphere at sea level. But under nonstandard conditions, TAS is found by applying a correction for pressure altitude and temperature to the CAS.

Some aircraft are equipped with true airspeed indicators that have a temperature-compensated aneroid bellows inside the instrument case. This bellows modifies the movement of the rocking shaft inside the instrument case so the pointer shows the actual TAS.

The true airspeed indicator provides both true and indicated airspeed. These instruments have the conventional airspeed mechanism, with an added subdial visible through cutouts in the regular dial. A knob on the instrument allows you to rotate the subdial and align an indication of the outside air temperature with the pressure altitude being flown. This alignment causes the instrument pointer to indicate the true airspeed on the subdial. [Figure 3-10]

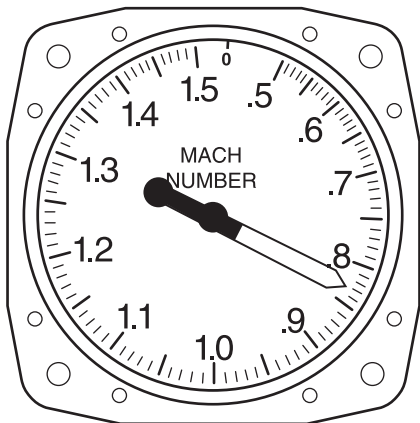


**Figure 3-10.** A true airspeed indicator allows the pilot to correct indicated airspeed for nonstandard temperature and pressure.

### Mach Number

As an aircraft approaches the speed of sound, the air flowing over certain areas of its surface speeds up until it reaches the speed of sound, and shock waves form. The indicated airspeed at which these conditions occur changes with temperature. Therefore airspeed, in this case, is not entirely adequate to warn the pilot of the impending problems. Mach number is more useful. Mach number is the ratio of the true airspeed of the aircraft to the speed of sound in the same atmospheric conditions. An aircraft flying at the speed of sound is flying at Mach 1.0.

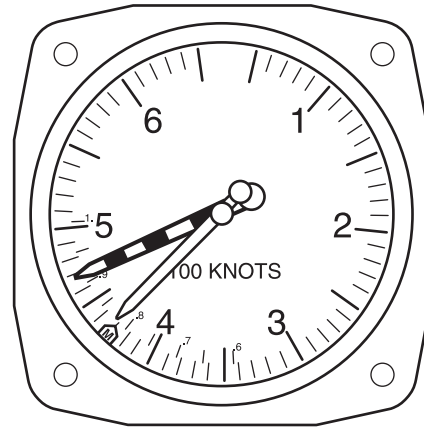
Most high-speed aircraft are limited as to the maximum Mach number they can fly. This is shown on a Machmeter as a decimal fraction. [Figure 3-11] For example, if the Machmeter indicates .83 and the aircraft is flying at 30,000 feet where the speed of sound under standard conditions is 589.5 knots, the airspeed is 489.3 knots. The speed of sound varies with the air temperature, and if the aircraft were flying at Mach .83 at 10,000 feet where the air is much warmer, its airspeed would be 530 knots.



**Figure 3-11.** A Machmeter shows the ratio of the speed of sound to the true airspeed the aircraft is flying.

### Maximum Allowable Airspeed

Some aircraft that fly at high subsonic speeds are equipped with maximum allowable airspeed indicators like the one in figure 3-12. This instrument looks much like a standard airspeed indicator, calibrated in knots, but has an additional pointer, colored red, checkered, or striped. The maximum airspeed pointer is actuated by an aneroid, or altimeter mechanism, that moves it to a lower value as air density decreases. By keeping the airspeed pointer at a lower value than the maximum pointer, the pilot avoids the onset of transonic shock waves.



**Figure 3-12.** A maximum allowable airspeed indicator has a movable pointer that indicates the never-exceed speed, which changes with altitude to avoid the onset of transonic shock waves.

### Airspeed Color Codes

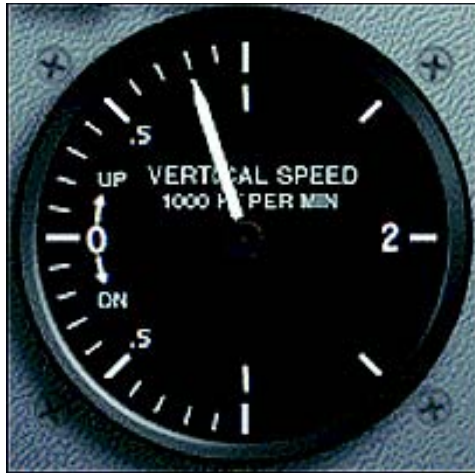
The dial of an airspeed indicator is color coded to alert you, at a glance, of the significance of the speed at which the aircraft is flying. These colors and their associated airspeeds are shown in figure 3-13.

White arc Bottom Top	Flap operating range Flaps-down stall speed Maximum airspeed for flaps-down flight
Green arc Bottom Top	Normal operating range Flaps-up stall speed Maximum airspeed for rough air
Blue radial line	Airspeed for best single-engine rate-of-climb
Yellow arc Bottom Top	Structural warning area Maximum airspeed for rough air Never-exceed airspeed
Red radial line	Never-exceed airspeed

**Figure 3-13.** Color codes for an airspeed indicator.

### Vertical Speed Indicators (VSI)

The vertical speed indicator (VSI) in figure 3-14 is also called a vertical velocity indicator (VVI) and was formerly known as a rate-of-climb indicator. It is a rate-of-pressure change instrument that gives an indication of any deviation from a constant pressure level.



**Figure 3-14.** Vertical speed indicator shows the rate of climb or descent in thousands of feet per minute.

Inside the instrument case is an aneroid very much like the one in an airspeed indicator. Both the inside of this aneroid and the inside of the instrument case are vented to the static system, but the case is vented through a **calibrated orifice** that causes the pressure inside the case to change more slowly than the pressure inside the aneroid. As the aircraft ascends, the static pressure becomes lower and the pressure inside the case compresses the aneroid, moving the pointer upward, showing a climb and indicating the number of feet per minute the aircraft is ascending.

When the aircraft levels off, the pressure no longer changes, the pressure inside the case becomes the same as that inside the aneroid, and the pointer returns to its horizontal, or zero, position. When the aircraft descends, the static pressure increases and the aneroid expands, moving the pointer downward, indicating a descent.

The pointer indication in a VSI lags a few seconds behind the actual change in pressure, but it is more sensitive than an altimeter and is useful in alerting the pilot of an upward or downward trend, thereby helping maintain a constant altitude.

**Calibrated orifice:** A hole of specific diameter used to delay the pressure change in the case of a vertical speed indicator.

Some of the more complex VSIs, called instantaneous vertical speed indicators (IVSI), have two accelerometer-actuated air pumps that sense an upward or downward pitch of the aircraft and instantaneously create a pressure differential. By the time the pressure caused by the pitch acceleration dissipates, the altitude pressure change is effective.

## Compass Systems

The Earth is a huge magnet, spinning in space, surrounded by a magnetic field made up of invisible **lines of flux**. These lines leave the surface at the magnetic north pole and reenter at the magnetic south pole.

Lines of magnetic flux have two important characteristics: any magnet that is free to rotate will align with them, and an electrical current is induced into any conductor that cuts across them. Most direction indicators installed in aircraft make use of one of these two characteristics.

### Magnetic Compass

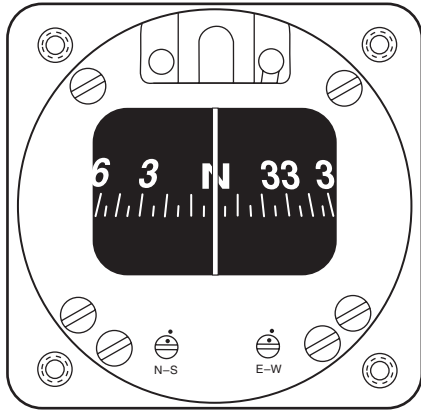
One of the oldest and simplest instruments for indicating direction is the magnetic compass. It is also one of the basic instruments required by 14 CFR part 91 for both VFR and IFR flight.

A magnet is a piece of material, usually a metal containing iron, that attracts and holds lines of magnetic flux. Every magnet regardless of size has two poles: a north pole and a south pole. When one magnet is placed in the field of another, the unlike poles attract each other and like poles repel.

An aircraft magnetic compass, such as the one in figure 3-15, has two small magnets attached to a metal float sealed inside a bowl of clear compass fluid similar to kerosene. A graduated scale, called a card, is wrapped around the float and viewed through a glass window with a **lubber line** across it. The card is marked with letters representing the cardinal directions, north, east, south, and west, and a number for each 30° between these letters. The final “0” is omitted from these directions; for example, 3 = 30°, 6 = 60°, and 33 = 330°. There are long and short graduation marks between the letters and numbers, with each long mark representing 10° and each short mark representing 5°.

**Lines of flux:** Invisible lines of magnetic force passing between the poles of a magnet.

**Lubber line:** The reference line used in a magnetic compass or heading indicator.



**Figure 3-15.** A magnetic compass.

The float and card assembly has a hardened steel pivot in its center that rides inside a special, spring-loaded, hard-glass jewel cup. The buoyancy of the float takes most of the weight off the pivot, and the fluid damps the oscillation of the float and card. This jewel-and-pivot type mounting allows the float freedom to rotate and tilt up to approximately 18° angle of bank. At steeper bank angles, the compass indications are erratic and unpredictable.

The compass housing is entirely full of compass fluid. To prevent damage or leakage when the fluid expands and contracts with temperature changes, the rear of the compass case is sealed with a flexible diaphragm, or in some compasses, with a metal bellows.

The magnets align with the Earth’s magnetic field and the pilot reads the direction on the scale opposite the lubber line. In figure 3-15, the pilot sees the compass card from its back side. When you are flying north as the compass shows, east is to your right, but on the card “33” which represents 330° (west of north) is to the right of north. The reason for this apparent backward graduation is that the card remains stationary, and the compass housing and the pilot turn around it, always viewing the card from its back side.

A compensator assembly mounted on the top or bottom of the compass allows an aviation maintenance technician (AMT) to create a magnetic field inside the compass housing that cancels the influence of local outside magnetic fields.

This is done to correct for deviation error. The compensator assembly has two shafts whose ends have screwdriver slots accessible from the front of the compass. Each shaft rotates one or two small compensating magnets. The end of one shaft is marked E-W, and its magnets affect the compass when the aircraft is pointed east or west. The other shaft is marked N-S and its magnets affect the compass when the aircraft is pointed north or south.

### Compass Errors

The magnetic compass is the simplest instrument in the panel, but it is subject to a number of errors that must be considered.

#### Variation

The Earth rotates about its geographic axis, and maps and charts are drawn using meridians of longitude that pass through the geographic poles. Directions measured from the geographic poles are called true directions. The north magnetic pole to which the magnetic compass points is not colocated with the geographic north pole but is some 1,300 miles away, and directions measured from the magnetic poles are called magnetic directions. In aerial navigation, the difference between true and magnetic directions is called **variation**. This same angular difference in surveying and land navigation is called declination.

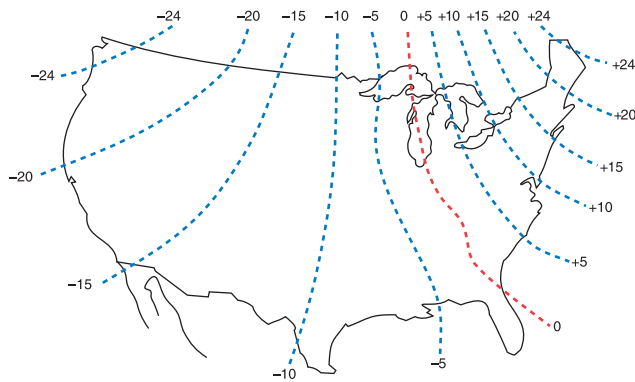
Figure 3-16 shows the **isogonic lines** that identify the number of degrees of variation in their area. The line that passes near Chicago is called the **agonic line**, and anywhere along this line the two poles are aligned, and there is no variation. East of this line, the magnetic pole is to the west of the geographic pole and a correction must be applied to a compass indication to get a true direction.

When you fly in the Washington, DC area, for example, the variation is 10° west, and if you want to fly a true course of south (180°), the variation must be added to this and the magnetic course to fly is 190°. When you fly in the Los Angeles, CA area, the variation is about 15° east. To fly a true course of 180° there, you would have to subtract the variation and fly a magnetic course of 165°. The variation error does not change with the heading of the aircraft; it is the same anywhere along the isogonic line.

**Variation:** The compass error caused by the difference in the physical locations of the magnetic north pole and the geographic north pole.

**Isogonic lines:** Lines drawn across aeronautical charts connecting points having the same magnetic variation.

**Agonic line:** An irregular imaginary line across the surface of the Earth along which the magnetic and geographic poles are in alignment and along which there is no magnetic variation.



**Figure 3-16.** Isogonic lines are lines of equal variation.

### Deviation

The magnets in a compass align with any magnetic field. Local magnetic fields in an aircraft caused by electrical current flowing in the structure, in nearby wiring or any magnetized part of the structure, will conflict with the Earth's magnetic field and cause a compass error called **deviation**.

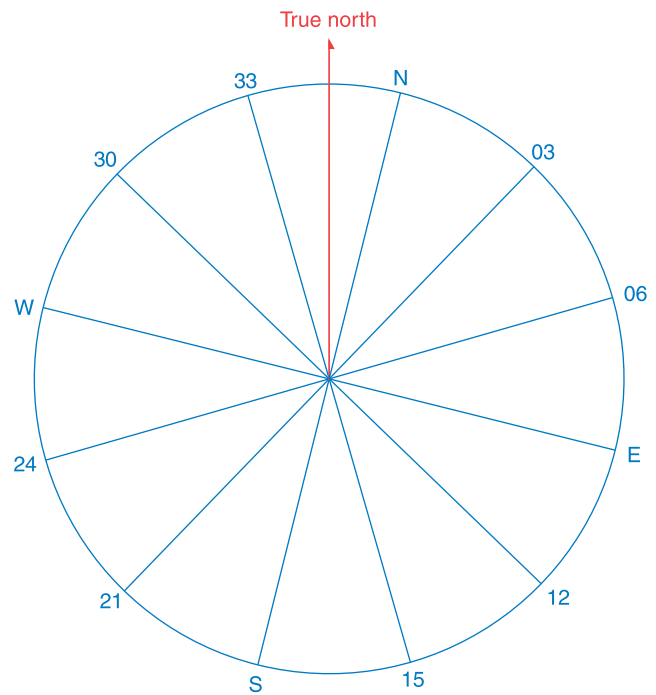
Deviation, unlike variation, is different on each heading, but it is not affected by the geographic location. Variation error cannot be reduced nor changed, but deviation error can be minimized when an AMT performs the maintenance task, "swinging the compass."

Most airports have a compass rose, which is a series of lines marked out on a taxiway or ramp at some location where there is no magnetic interference. Lines, oriented to magnetic north, are painted every 30° as shown in figure 3-17.

The AMT aligns the aircraft on each magnetic heading and adjusts the compensating magnets to minimize the difference between the compass indication and the actual magnetic heading of the aircraft. Any error that cannot be removed is recorded on a compass correction card, like the one in figure 3-18, and placed in a card holder near the compass. If you want to fly a magnetic heading of 120°, and the aircraft is operating with the radios on, you would have to fly a compass heading of 123°.

**Deviation:** A magnetic compass error caused by local magnetic fields within the aircraft. Deviation error is different on each heading.

**Compass course:** A true course corrected for variation and deviation errors.



**Figure 3-17.** A compass rose upon which deviation error is compensated for.

FOR	000	030	060	090	120	150
STEER						
RDO. ON	001	032	062	095	123	155
RDO. OFF	002	031	064	094	125	157

FOR	180	210	240	270	300	330
STEER						
RDO. ON	176	210	243	271	296	325
RDO. OFF	174	210	240	273	298	327

**Figure 3-18.** A compass correction card shows the deviation correction for any heading.

The corrections for variation and deviation must be applied in the correct sequence. To find the **compass course** when the true course is known:

$$\begin{aligned} \text{True Course} \pm \text{Variation} &= \text{Magnetic Course} \pm \text{Deviation} \\ &= \text{Compass Course} \end{aligned}$$

### Mnemonic aid for calculating magnetic course:

East is least (subtract variation from true course), west is best (add variation to true course).



To find the true course that is being flown when the compass course is known:

$$\text{Compass Course} \pm \text{Deviation} = \text{Magnetic Course} \pm \text{Variation} = \text{True Course}$$

### Dip Errors

The lines of magnetic flux are considered to leave the Earth at the magnetic north pole and enter at the magnetic south pole. At both locations the lines are perpendicular to the Earth's surface. At the magnetic equator, which is halfway between the poles, the lines are parallel with the surface. The magnets in the compass align with this field, and near the poles they dip, or tilt, the float and card. The float is balanced with a small dip-compensating weight, so it stays relatively level when operating in the middle latitudes of the northern hemisphere. This dip along with this weight causes two very noticeable errors: northerly turning error and acceleration error.

The pull of the vertical component of the Earth's magnetic field causes northerly turning error, which is apparent on a heading of north or south. When an aircraft, flying on a heading of north, makes a turn toward east, the aircraft banks to the right, and the compass card tilts to the right. The vertical component of the Earth's magnetic field pulls the north-seeking end of the magnet to the right, and the float rotates, causing the card to rotate toward west, the direction opposite the direction the turn is being made. [Figure 3-19]

If the turn is made from north to west, the aircraft banks to the left and the card tilts to the left. The magnetic field pulls on the end of the magnet that causes the card to rotate toward east. This indication is again opposite to the direction the turn is being made. The rule for this error is: when starting a turn from a northerly heading, the compass indication lags behind the turn.

When an aircraft is flying on a heading of south and begins a turn toward east, the Earth's magnetic field pulls on the end of the magnet that rotates the card toward east, the same direction the turn is being made. If the turn is made from south toward west, the magnetic pull will start the card rotating toward west—again, in the same direction the turn is being made. The rule for this error is: When starting a turn from a southerly heading, the compass indication leads the turn.

In acceleration error, the dip-correction weight causes the end of the float and card marked N (this is the south-seeking end) to be heavier than the opposite end. When the aircraft is flying at a constant speed on a heading of either east or west, the float and card are level. The effects of magnetic dip and the weight are approximately equal. If the aircraft accelerates on a heading of east (as in figure 3-20), the inertia of the weight holds its end of the float back, and the card rotates toward north. As soon as the speed of the aircraft stabilizes, the card swings back to its east indication.

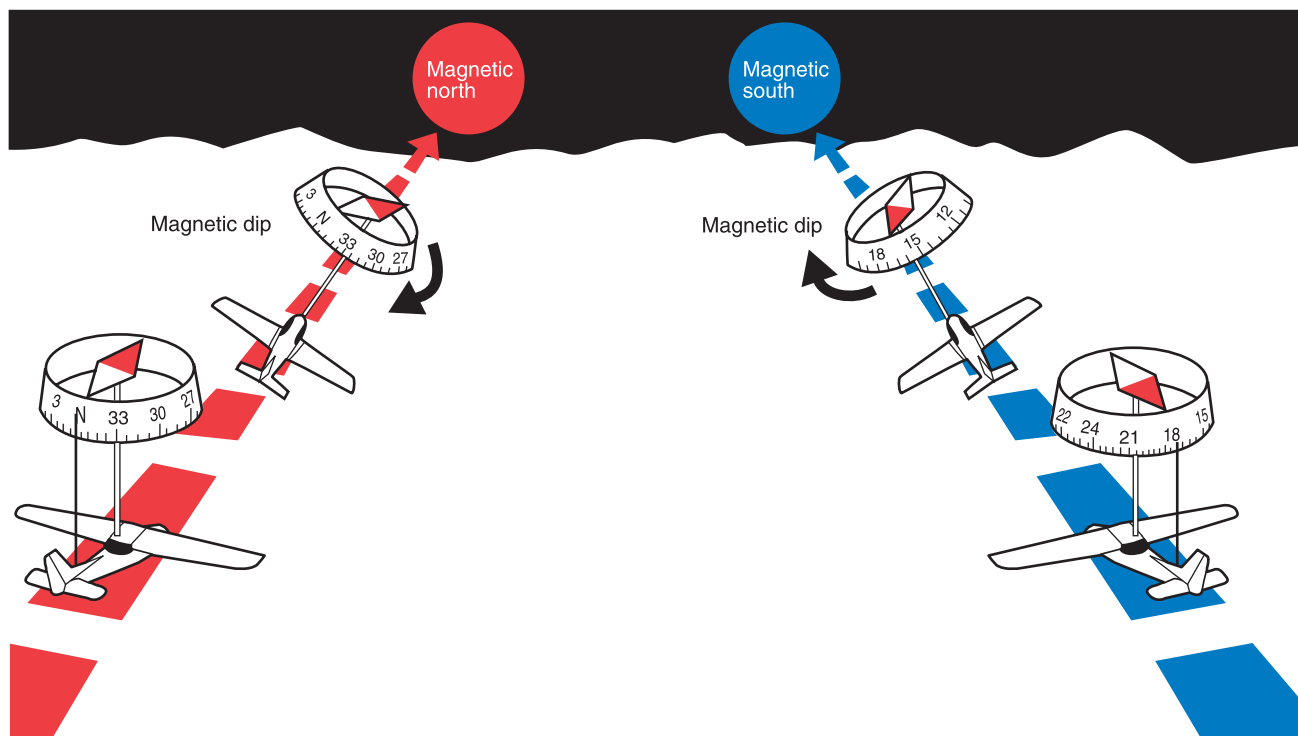
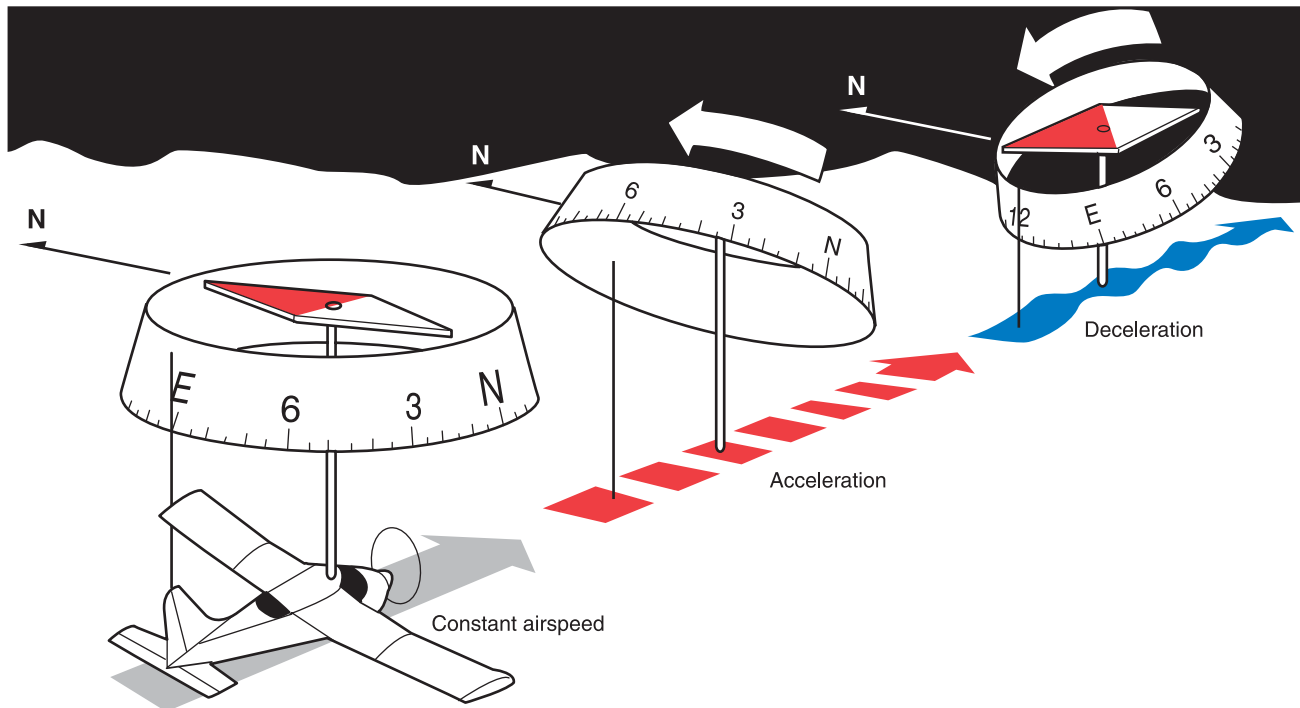


Figure 3-19. Northerly turning error.



**Figure 3-20.** *The effects of acceleration error.*

If, while flying on this easterly heading, the aircraft decelerates, the inertia causes the weight to move ahead and the card rotates toward south until the speed again stabilizes.

When flying on a heading of west, the same things happen. Inertia from acceleration causes the weight to lag, and the card rotates toward north. When the aircraft decelerates on a heading of west, inertia causes the weight to move ahead and the card rotates toward south.

#### *Oscillation Error*

Oscillation is a combination of all of the other errors, and it results in the compass card swinging back and forth around the heading being flown. When setting the gyroscopic heading indicator to agree with the magnetic compass, use the average indication between the swings.

#### **Lags or Leads**

When starting a turn from a northerly heading, the compass lags behind the turn. When starting a turn from a southerly heading, the compass leads the turn.

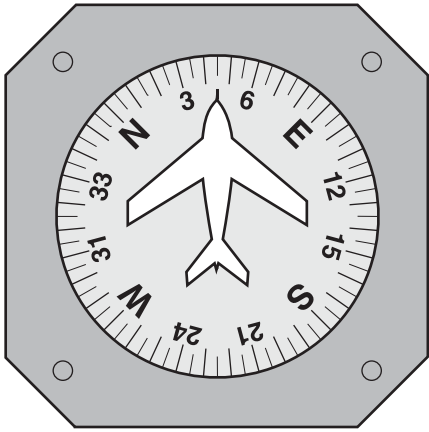
#### **ANDS**

A memory jogger for the effect of acceleration error is the word “ANDS”: Acceleration causes an indication toward North, Deceleration causes an indication toward South.

#### **Vertical Card Magnetic Compasses**

The floating-magnet type of compass not only has all the errors just described, but lends itself to confused reading. It is easy to begin a turn in the wrong direction because its card appears backward. East is on the west side. The vertical card magnetic compass eliminates some of the errors and confusion. The dial of this compass is graduated with letters representing the cardinal directions, numbers every 30°, and marks every 5°. The dial is rotated by a set of gears from the shaft-mounted magnet, and the nose of the symbolic airplane on the instrument glass represents the lubber line for reading the heading of the aircraft from the dial. Oscillation of the magnet is damped by **eddy currents** induced into an aluminum damping cup. [Figure 3-21]

**Eddy currents:** Current induced in a metal cup or disc when it is crossed by lines of flux from a moving magnet.



**Figure 3-21.** A vertical card magnetic compass.

### Flux Gate Compass

As mentioned earlier, the lines of flux in the Earth's magnetic field have two basic characteristics: a magnet will align with these lines, and an electrical current is induced, or generated, in any wire crossed by them.

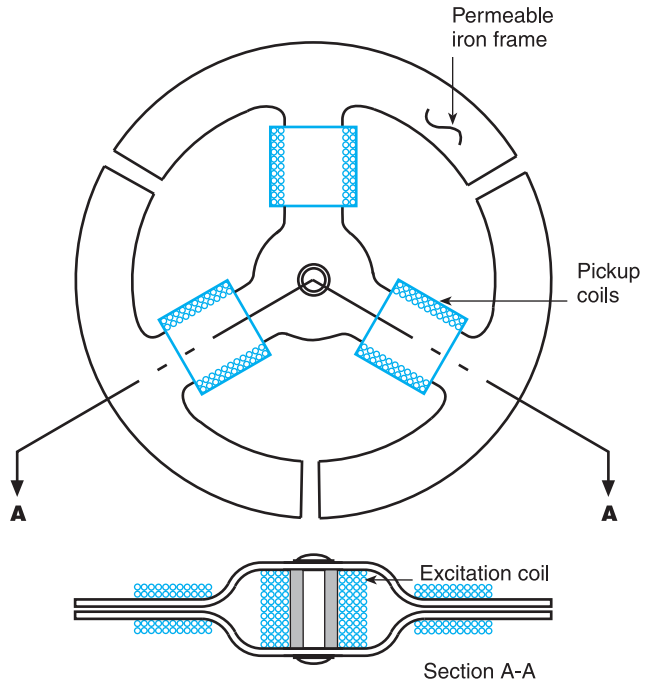
The flux gate compass that drives slaved gyros uses the characteristic of **current induction**. The flux valve is a small segmented ring, like the one in figure 3-22, made of soft iron that readily accepts lines of magnetic flux. An electrical coil is wound around each of the three legs to accept the current induced in this ring by the Earth's magnetic field. A coil wound around the iron spacer in the center of the frame has 400-Hz alternating current (a.c.) flowing through it. During the times when this current reaches its peak, twice during each cycle, there is so much magnetism produced by this coil that the frame cannot accept the lines of flux from the Earth's field.

But as the current reverses between the peaks, it demagnetizes the frame so it can accept the flux from the Earth's field. As this flux cuts across the windings in the three coils, it causes current to flow in them. These three coils are connected in such a way that the current flowing in them changes as the heading of the aircraft changes. [Figure 3-23]

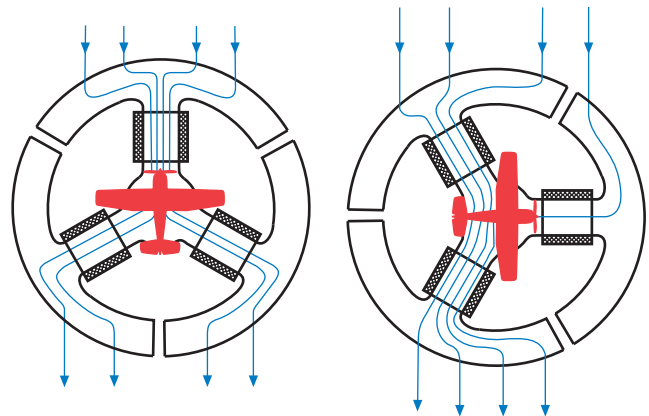
The three coils are connected to three similar but smaller coils in a **synchro** inside the instrument case. The synchro rotates the dial of a radio magnetic indicator (RMI) or a horizontal situation indicator (HSI).

**Current induction:** An electrical current is induced into, or generated in, any conductor that is crossed by lines of flux from any magnet.

**Synchro:** A device used to transmit indications of angular movement or position from one location to another.



**Figure 3-22.** The soft iron frame of the flux valve accepts the flux from the Earth's magnetic field each time the current in the center coil reverses. This flux causes current to flow in the three pickup coils.



**Figure 3-23.** The current in each of the three pickup coils changes with the heading of the aircraft.

### Remote Indicating Compass

Remote indicating compasses were developed to compensate for the errors and limitations of the older type of heading indicators. The two panel-mounted components of a typical system are the pictorial navigation indicator, and the slaving control and compensator unit. [Figure 3-24] The pictorial navigation indicator is commonly referred to as a horizontal situation indicator.



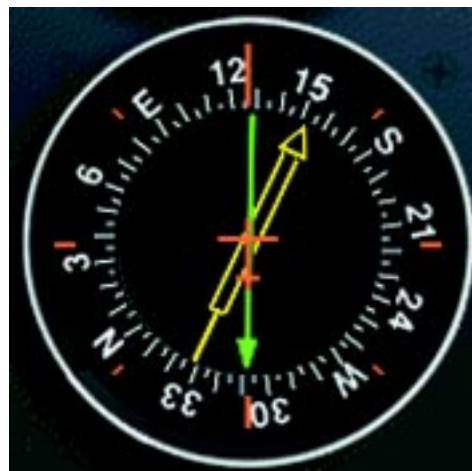
**Figure 3-24.** Pictorial navigation indicator; slaving control and compensator unit.

The slaving control and compensator unit has a pushbutton that provides a means of selecting either the “slaved gyro” or “free gyro” mode. This unit also has a slaving meter and two manual heading-drive buttons. The slaving meter indicates the difference between the displayed heading and the magnetic heading. A right deflection indicates a clockwise error of the compass card; a left deflection indicates a counterclockwise error. Whenever the aircraft is in a turn and the card rotates, the slaving meter will show a full deflection to one side or the other. When the system is in “free gyro” mode, the compass card may be adjusted by depressing the appropriate heading-drive button.

A separate unit, the magnetic slaving transmitter is mounted remotely; usually in a wingtip to eliminate the possibility of magnetic interference. It contains the flux valve, which is the direction-sensing device of the system. A concentration of lines of magnetic force, after being amplified, becomes a signal relayed to the heading indicator unit which is also remotely mounted. This signal operates a torque motor in the heading indicator unit which precesses the gyro unit until it is aligned with the transmitter signal. The magnetic slaving transmitter is connected electrically to the HSI.

There are a number of designs of the remote indicating compass; therefore, only the basic features of the system are covered here. As an instrument pilot, you should become familiar with the characteristics of the equipment in your aircraft.

As instrument panels become more crowded and the pilot’s available scan time is reduced by a heavier cockpit workload, instrument manufacturers have worked towards combining instruments. One good example of this is the RMI in figure 3-25. The compass card is driven by signals from the flux valve, and the two pointers are driven by an **automatic direction finder (ADF)** and a **very-high-frequency omnidirectional range (VOR)**.



**Figure 3-25.** The compass card in this RMI is driven by signals from a flux valve and it indicates the heading of the aircraft opposite the upper center index mark.

**Automatic direction finder (ADF):** Electronic navigation equipment that operates in the low- and medium-frequency bands.

**Very-high-frequency omnidirectional range (VOR):** Electronic navigation equipment in which the cockpit instrument identifies the radial or line from the VOR station measured in degrees clockwise from magnetic north, along which the aircraft is located.

## Gyroscopic Systems

Flight without reference to a visible horizon can be safely accomplished by the use of gyroscopic instrument systems and the two characteristics of gyroscopes which are: **rigidity** and **precession**. These systems include: attitude, heading, and rate instruments, along with their power sources. These instruments include a gyroscope (or gyro) which is a small wheel with its weight concentrated around its periphery. When this wheel is spun at high speed, it becomes rigid and resists any attempt to tilt it or turn it in any direction other than around its spin axis.

Attitude and heading instruments operate on the principal of rigidity. For these instruments the gyro remains rigid in its case and the aircraft rotates about it.

Rate indicators, such as turn indicators and turn coordinators, operate on the principal of precession. In this case the gyro precesses (or rolls over) proportionate to the rate the aircraft rotates about one or more of its axes.

### Power Sources

Aircraft and instrument manufacturers have designed redundancy into the flight instruments so that any single failure will not deprive the pilot of his/her ability to safely conclude the flight.

Gyroscopic instruments are crucial for instrument flight; therefore, they are powered by separate electrical or pneumatic sources.

### Electrical Systems

Many general aviation aircraft that use pneumatic attitude indicators use electric rate indicators and vice versa. Some instruments identify their power source on their dial, but it is extremely important that pilots consult the POH/AFM to determine the power source of all instruments to know what action to take in the event of an instrument failure.

Direct current (d.c.) electrical instruments are available in 14- or 28-volt models, depending upon the electrical system in the aircraft. Alternating current (a.c.) is used to operate some attitude gyros and autopilots. Aircraft that have only d.c. electrical systems can use a.c. instruments by installing a solid-state d.c. to a.c. **inverter**, which changes 14 or 28 volts d.c. into three-phase 115-volt, 400-Hz a.c.

**Rigidity:** The characteristic of a gyroscope that prevents its axis of rotation tilting as the Earth rotates.

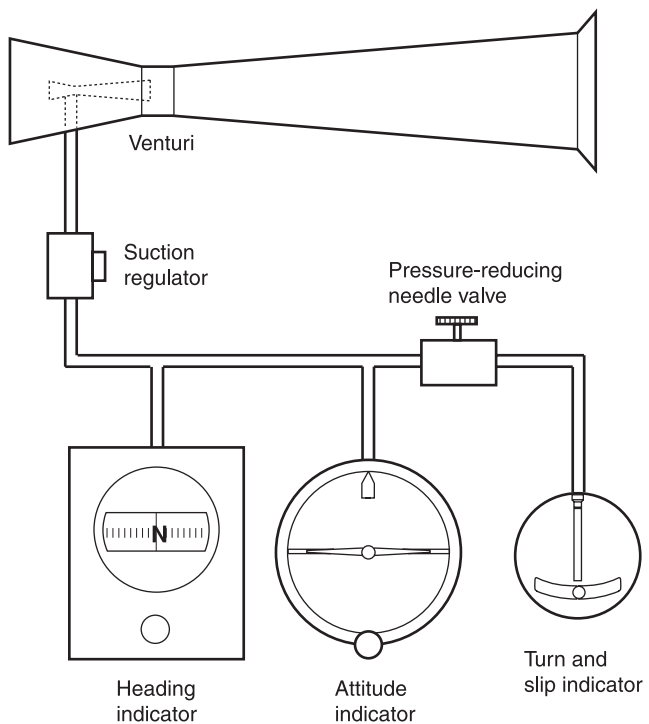
**Precession:** The characteristic of a gyroscope that causes an applied force to be felt, not at the point of application, but 90° from that point in the direction of rotation.

## Pneumatic Systems

Pneumatic gyros are driven by a jet of air impinging on buckets cut into the periphery of the wheel. This stream of air is obtained on many aircraft by evacuating the instrument case and allowing filtered air to flow into the case through a nozzle to spin the wheel.

### Venturi Tube Systems

Aircraft that do not have a pneumatic pump to evacuate the instrument cases can use **venturi tubes** mounted on the outside of the aircraft, similar to the system shown in figure 3-26. Air flowing through these tubes speeds up in the narrowest part, and according to Bernoulli's principle, the pressure drops. This location is connected to the instrument case by a piece of tubing. The two attitude instruments operate on approximately 4" Hg suction; the turn-and-slip indicator needs only 2" Hg, so a pressure-reducing needle valve is used to decrease the suction. Filtered air flows into the instruments through filters built into the instrument cases. In this system, ice can clog the venturi tube and stop the instruments when they are most needed.



**Figure 3-26.** A venturi tube provides the low pressure inside the instrument case to drive the gyros.

**Inverter:** A solid-state electronic device that converts electrical current from d.c. into a.c. to operate a.c. gyro instruments.

**Venturi tube:** A specially-shaped tube attached to the outside of an aircraft to produce suction to operate gyro instruments.

### Wet-Type Vacuum Pump Systems

Steel-vane air pumps have been used for many years to evacuate the instrument cases. The discharge air is used to inflate rubber deicer boots on the wing and empennage leading edges. The vanes in these pumps are lubricated by a small amount of engine oil metered into the pump and this oil is discharged with the air. To keep the oil from deteriorating the rubber boots, it must be removed with an oil separator like the one in figure 3-27.

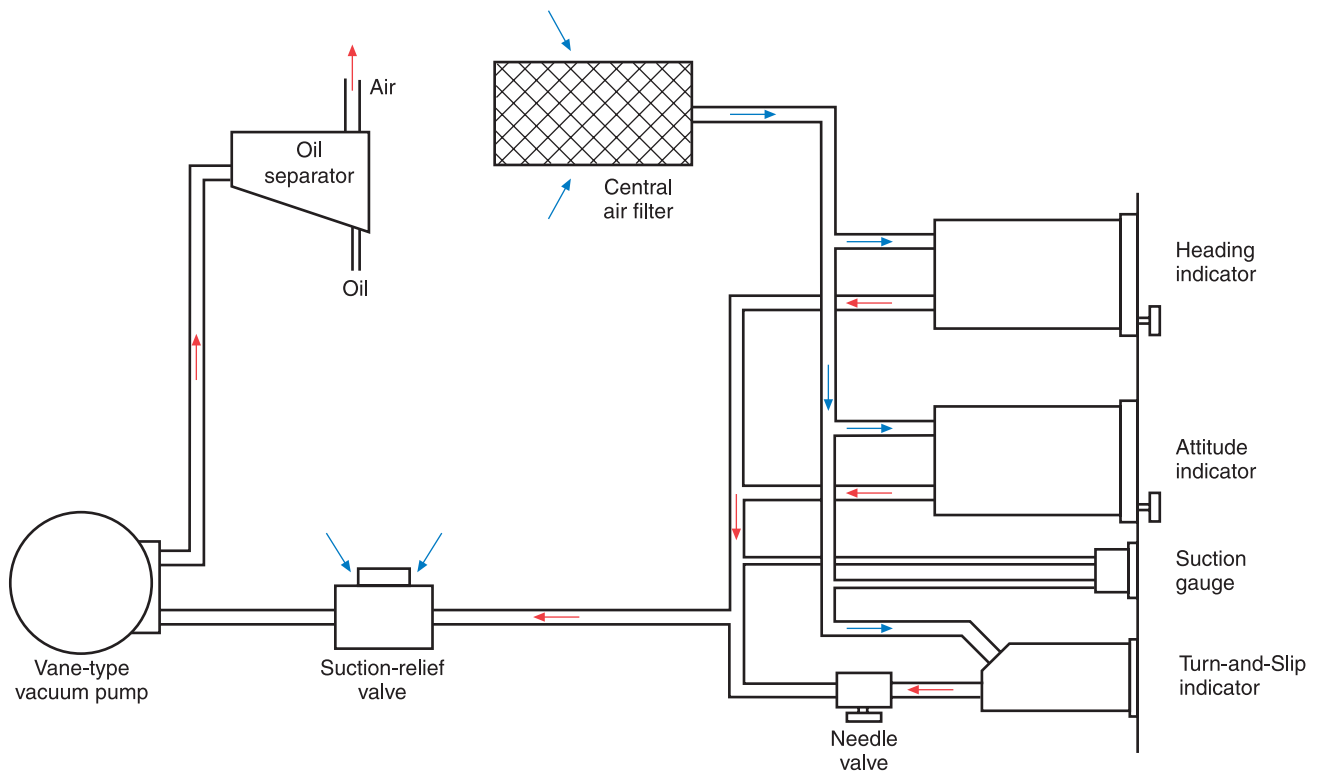
The vacuum pump moves a greater volume of air than is needed to supply the instruments with the suction needed, so a **suction-relief valve** is installed in the inlet side of the pump. This spring-loaded valve draws in just enough air to maintain the required low pressure inside the instruments, as is shown on the suction gauge in the instrument panel. Filtered air

enters the instrument cases from a central air filter. As long as aircraft fly at relatively low altitudes, enough air is drawn into the instrument cases to spin the gyros at a sufficiently high speed.

### Dry-Air Pump Systems

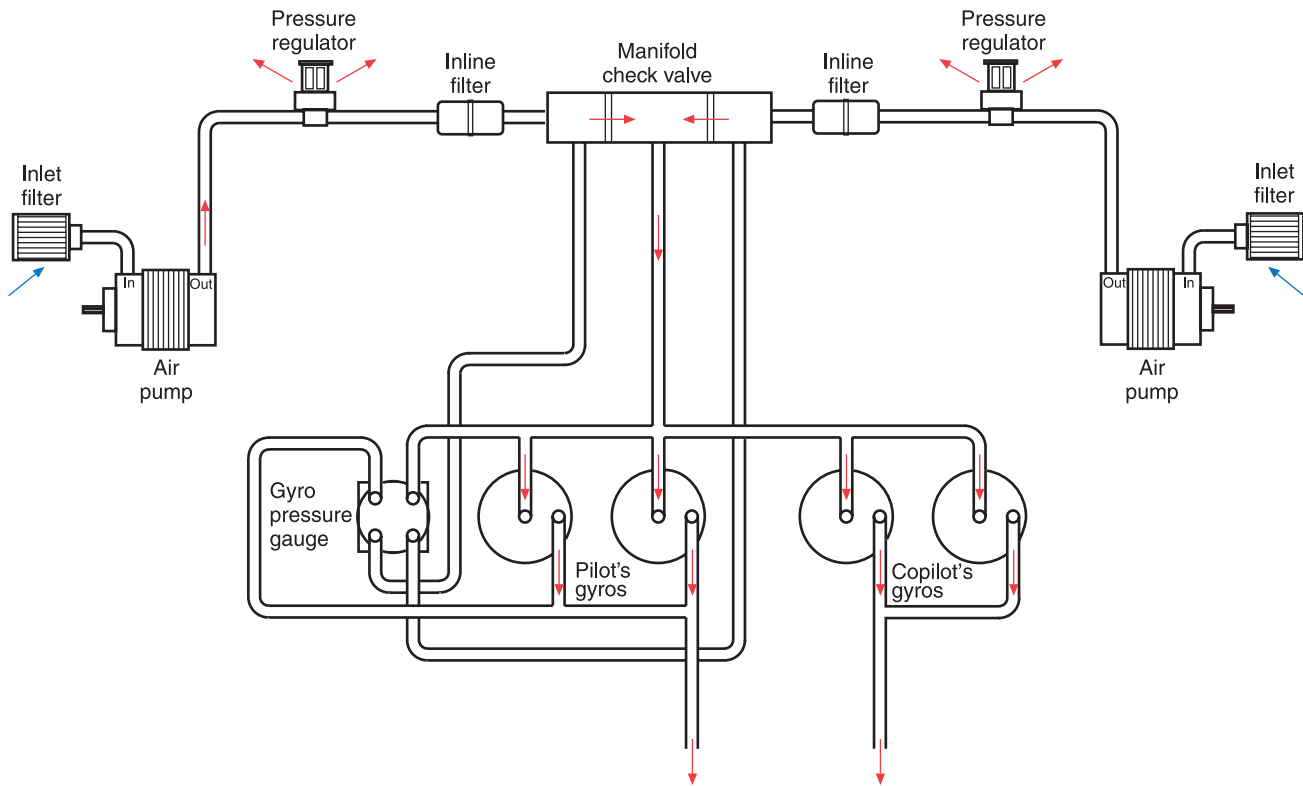
As flight altitudes increase, the air is less dense and more air must be forced through the instruments. Air pumps that do not mix oil with the discharge air are used in high-flying aircraft.

Steel vanes sliding in a steel housing need to be lubricated, but vanes made of a special formulation of carbon sliding inside a carbon housing provide their own lubrication as they wear in a microscopic amount.



**Figure 3-27.** Single-engine instrument vacuum system using a steel-vane wet-type vacuum pump.

**Suction-relief valve:** A relief valve in an instrument vacuum system to maintain the correct low pressure inside the instrument case for the proper operation of the gyros.



**Figure 3-28.** Twin-engine instrument pressure system using a carbon-vane dry-type air pump.

### Pressure Systems

Figure 3-28 is a diagram of the instrument pneumatic system of a twin-engine general aviation airplane. Two dry air pumps are used with filters in their inlet to filter out any contaminants that could damage the fragile carbon vanes in the pump. The discharge air from the pump flows through a regulator, where excess air is bled off to maintain the pressure in the system at the desired level. The regulated air then flows through inline filters to remove any contamination that could have been picked up from the pump, and from there into a manifold check valve. If either engine should become inoperative, or if either pump should fail, the check valve will isolate the inoperative system and the instruments will be driven by air from the operating system. After the air passes through the instruments and drives the gyros, it is exhausted from the case. The gyro pressure gauge measures the pressure drop across the instruments.

## Gyroscopic Instruments

### Attitude Indicators

The first attitude instrument (AI) was originally referred to as an artificial horizon, later as a gyro horizon; now it is more properly called an attitude indicator. Its operating mechanism is a small brass wheel with a vertical spin axis, spun at a high speed by either a stream of air impinging on buckets cut into its periphery, or by an electric motor. The gyro is mounted in a **double gimbal**, which allows the aircraft to pitch and roll about the gyro as it remains fixed in space.

A horizon disk is attached to the gimbals so it remains in the same plane as the gyro, and the aircraft pitches and rolls about it. On the early instruments, this was just a bar that represented the horizon, but now it is a disc with a line representing the horizon and both pitch marks and bank-angle lines. The top half of the instrument dial and horizon disc is blue, representing the sky; and the bottom half is brown, representing

**Double gimbal:** A type of mount used for the gyro in an attitude instrument. The axes of the two gimbals are at right angles to the spin axis of the gyro allowing free motion in two planes around the gyro.

the ground. A bank index at the top of the instrument shows the angle of bank marked on the banking scale with lines that represent 10°, 20°, 30°, 60°, and 90°. [Figure 3-29]



**Figure 3-29.** The dial of this attitude indicator has reference lines to show pitch and roll.

A small symbolic aircraft is mounted in the instrument case so it appears to be flying relative to the horizon. A knob at the bottom center of the instrument case raises or lowers the aircraft to compensate for pitch trim changes as the airspeed changes. The width of the wings of the symbolic aircraft and the dot in the center of the wings represent a pitch change of approximately 2°.

For an AI to function properly, the gyro must remain vertically upright while the aircraft rolls and pitches around it. The bearings in these instruments have a minimum of friction; however, even this small amount places a restraint on the gyro which produces a precessive force causing the gyro to tilt. To minimize this tilting, an erection mechanism inside the instrument case applies a force any time the gyro tilts from its vertical position. This force acts in such a way to return the spinning wheel to its upright position.

The older artificial horizons were limited in the amount of pitch or roll they could tolerate, normally about 60° in pitch and 100° in roll. After either of these limits was exceeded, the gyro housing contacted the gimbal, applying such a precessive force that the gyro tumbled. Because of this limitation, these instruments had a caging mechanism that locked the gyro in its vertical position during any maneuvers that exceeded the instrument limits. Newer instruments do

not have these restrictive tumble limits; therefore, they do not have a caging mechanism.

When an aircraft engine is first started and pneumatic or electric power is supplied to the instruments, the gyro is not erect. A self-erecting mechanism inside the instrument actuated by the force of gravity applies a precessive force, causing the gyro to rise to its vertical position. This erection can take as long as 5 minutes, but is normally done within 2 to 3 minutes.

Attitude indicators are free from most errors, but depending upon the speed with which the erection system functions, there may be a slight nose-up indication during a rapid acceleration and a nose-down indication during a rapid deceleration. There is also a possibility of a small bank angle and pitch error after a 180° turn. These inherent errors are small and correct themselves within a minute or so after returning to straight-and-level flight.

### Heading Indicators

A magnetic compass is a dependable instrument and is used as a backup instrument. But it has so many inherent errors that it has been supplemented with gyroscopic heading indicators.

The gyro in an attitude indicator is mounted in a double gimbal in such a way that its spin axis is *vertical*. It senses pitch and roll, but cannot sense rotation about its vertical, or spin, axis. The gyro in a heading indicator is also mounted in a double gimbal, but its spin axis is *horizontal*, and it senses rotation about the vertical axis of the aircraft.

Gyro heading indicators, with the exception of slaved gyro indicators, are not north-seeking, and they must be set to the appropriate heading by referring to a magnetic compass. Rigidity causes them to maintain this heading indication, without the oscillation and other errors inherent in a magnetic compass.

Older directional gyros use a drum-like card marked in the same way as the magnetic compass card. The gyro and the card remain rigid inside the case, and you view the card from the back. This allows the possibility you might start a turn in the wrong direction. A knob on the front of the instrument, below the dial, can be pushed in to engage the gimbals. This locks the gimbals and allows you to rotate the gyro and card until the number opposite the lubber line is the same as that of the magnetic compass. When the knob is pulled out, the gyro remains rigid and the aircraft is free to turn around the card.



Directional gyros are almost all air-driven by evacuating the case and allowing filtered air to flow into the case and out through a nozzle, blowing against buckets cut in the periphery of the wheel. Bearing friction causes the gyro to precess and the indication to drift. When using these instruments, it is standard practice to reset them to agree with the magnetic compass about every 15 minutes.

Heading indicators like the one in figure 3-30 work on the same principle as the older horizontal card indicators, except that the gyro drives a vertical dial that looks much like the dial of a vertical card magnetic compass. The heading of the aircraft is shown against the nose of the symbolic aircraft on the instrument glass, which serves as the lubber line. A knob in the front of the instrument may be pushed in and turned to rotate the gyro and dial. The knob is spring-loaded so it will disengage from the gimbals as soon as it is released. This instrument should be checked about every 15 minutes to see if it agrees with the magnetic compass.



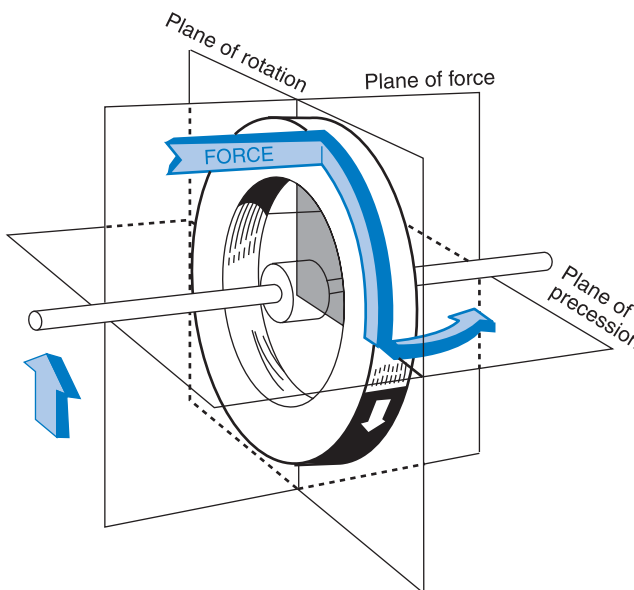
**Figure 3-30.** The heading indicator is not north-seeking, but must be set to agree with the magnetic compass.

### Turn Indicators

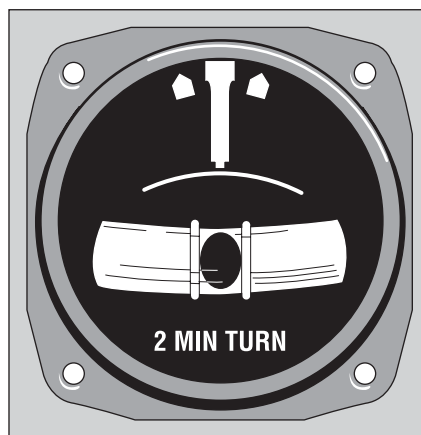
Attitude and heading indicators function on the principle of rigidity, but rate instruments such as the turn-and-slip indicator operate on precession. Precession is the characteristic of a gyroscope that causes an applied force to produce a movement, not at the point of application, but at a point 90° from the point of application in the direction of rotation. [Figure 3-31]

#### Turn-and-Slip Indicator

The first gyroscopic aircraft instrument was the turn indicator in the needle and ball, or turn-and-bank indicator, which has more recently been called a turn-and-slip indicator. [Figure 3-32]



**Figure 3-31.** Precession causes a force applied to a spinning wheel to be felt 90° from the point of application in the direction of rotation.



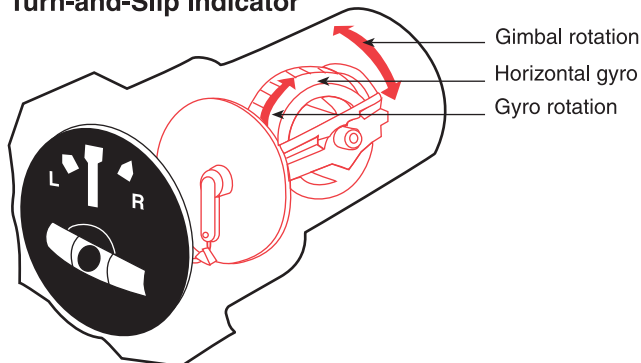
**Figure 3-32.** The turn-and-slip indicator.

The inclinometer in the instrument is a black glass ball sealed inside a curved glass tube that is partially filled with a liquid, much like compass fluid. This ball measures the relative strength of the force of gravity and the force of inertia caused by a turn. When the aircraft is flying straight-and-level, there is no inertia acting on the ball, and it remains in the center of the tube between two wires. In a turn made with a bank angle that is too steep, the force of gravity is greater than the inertia and the ball rolls down to the inside of the turn. If the turn is made with too shallow a bank angle, the inertia is greater than gravity and the ball rolls upward to the outside of the turn.

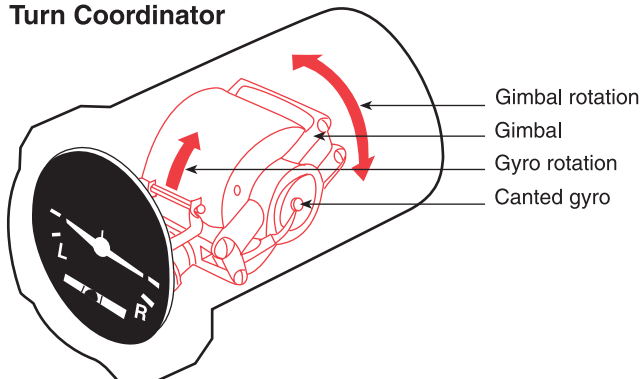
The inclinometer does not indicate the amount of bank, neither is it limited to an indication of slip; it only indicates the relationship between the angle of bank and the rate of yaw.

The turn indicator is a small gyro spun either by air or by an electric motor. The gyro is mounted in a single gimbal with its spin axis parallel to the lateral axis of the aircraft and the axis of the gimbal parallel with the longitudinal axis. [Figure 3-33]

### Turn-and-Slip Indicator



### Turn Coordinator



**Figure 3-33.** The rate gyro in a turn-and-slip indicator and turn coordinator.

When the aircraft yaws, or rotates about its vertical axis, it produces a force in the horizontal plane that, due to precession, causes the gyro and its gimbal to rotate about the gimbal axis. It is restrained in this rotation plane by a calibration spring; it rolls over just enough to cause the

pointer to deflect until it aligns with one of the **doghouse**-shaped marks on the dial, when the aircraft is making a standard-rate turn.

The dial of these instruments is marked “2 MIN TURN.” Some turn-and-slip indicators used in faster aircraft are marked “4 MIN TURN.” In either instrument, a standard-rate turn is being made whenever the needle aligns with a doghouse.

### Turn Coordinator

The major limitation of the older turn-and-slip indicator is that it senses rotation only about the vertical axis of the aircraft. It tells nothing of the rotation around the longitudinal axis, which in normal flight occurs before the aircraft begins to turn.

A turn coordinator operates on precession, the same as the turn indicator, but its gimbal frame is angled upward about 30° from the longitudinal axis of the aircraft. This allows it to sense both roll and yaw. Some turn coordinator gyros are dual-powered and can be driven by either air or electricity.

Rather than using a needle as an indicator, the gimbal moves a dial on which is the rear view of a symbolic aircraft. The bezel of the instrument is marked to show wings-level flight and bank angles for a standard-rate turn. [Figure 3-34]



**Figure 3-34.** A turn coordinator senses rotation about both the roll and yaw axes.

**Doghouse:** A mark on the dial of a turn-and-slip indicator that has the shape of a doghouse.

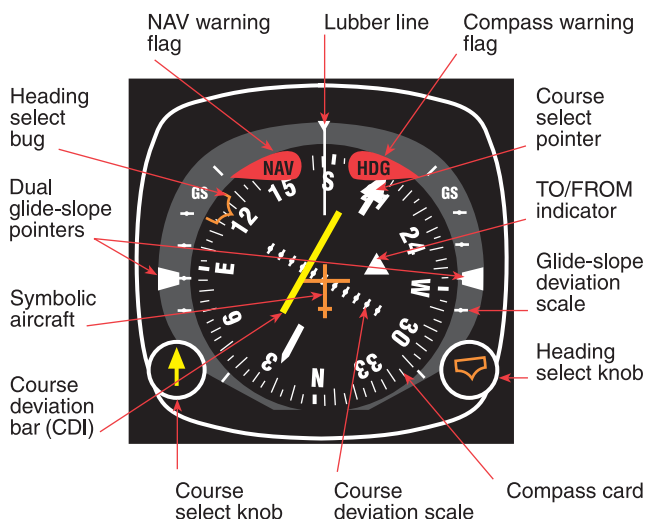
The inclinometer, similar to the one in a turn-and-slip indicator, is called a coordination ball, which shows the relationship between the bank angle and the rate of yaw. The turn is coordinated when the ball is in the center, between the marks. The aircraft is skidding when the ball rolls toward the outside of the turn and is slipping when it moves toward the inside of the turn.

A turn coordinator does not sense pitch. This is indicated on some instruments by placing the words “NO PITCH INFORMATION” on the dial.

## Flight Director Systems

### Horizontal Situation Indicator (HSI)

The HSI is a direction indicator that uses the output from a flux valve to drive the dial, which acts as the compass card. This instrument, shown in figure 3-35, combines the magnetic compass with navigation signals and a glide slope. This gives the pilot an indication of the location of the aircraft with relationship to the chosen course.



**Figure 3-35.** Horizontal situation indicator (HSI).

In figure 3-35, the aircraft heading displayed on the rotating azimuth card under the upper lubber line is 175°. The course-indicating arrowhead shown is set to 205°; the tail indicates the reciprocal, 025°. The course deviation bar operates with a VOR/Localizer (VOR/LOC) navigation receiver to indicate left or right deviations from the course selected with the course-indicating arrow, operating in the same manner that the angular movement of a conventional VOR/LOC needle indicates deviation from course.

The desired course is selected by rotating the course-indicating arrow in relation to the azimuth card by means of the course select knob. This gives you a pictorial presentation: the fixed aircraft symbol and course deviation bar display the aircraft relative to the selected course, as though you were above the aircraft looking down. The TO/FROM indicator is a triangular-shaped pointer. When the indicator points to the head of the course arrow, it shows that the course selected, if properly intercepted and flown, will take the aircraft to the selected facility. When the indicator points to the tail of the course arrow, it shows that the course selected, if properly intercepted and flown, will take the aircraft directly away from the selected facility.

The glide-slope deviation pointer indicates the relation of the aircraft to the glide slope. When the pointer is below the center position, the aircraft is above the glide slope, and an increased rate of descent is required. In some installations, the azimuth card is a remote indicating compass; however, in others the heading must be checked against the magnetic compass occasionally and reset with the course select knob.

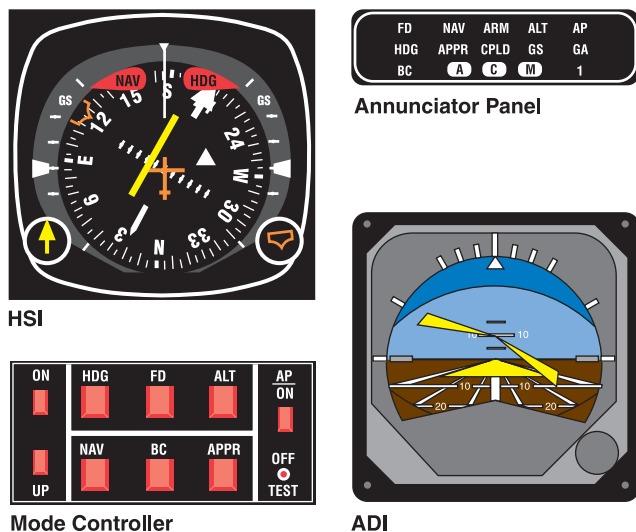
### Attitude Director Indicator (ADI)

Advances in attitude instrumentation combine the gyro horizon with other instruments such as the HSI, thereby reducing the number of separate instruments the pilot must devote attention to. The attitude director indicator (ADI) is an example of such an advancement upon the attitude indicator. An integrated flight director system consists of electronic components that compute and indicate the aircraft attitude required to attain and maintain a preselected flight condition.

The ADI in figure 3-36 furnishes the same information as an attitude indicator, but has the additional feature of a set of computer-driven bowtie-shaped steering bars. Instead of the symbolic aircraft, a delta-shaped symbol represents the aircraft being flown.

The mode controller provides signals through the ADI to drive the steering bars. The pilot flies the aircraft to place the delta symbol in the V of the steering bars. “Command” indicators tell the pilot in which direction and how much to change aircraft attitude to achieve the desired result. The computed command indications relieve the pilot of many of the mental calculations required for instrument flight.

The flight director/autopilot system described below is typical of installations in some of the more complex general aviation aircraft. The components in the instrument panel include the mode controller, ADI, HSI, and annunciator panel. These units are illustrated in figure 3-36.



**Figure 3-36.** *Integrated flight system.*

The mode controller has six pushbutton switches for turning on the flight director system and selection of all modes, a switch for autopilot engagement, a trim switch, and a preflight test button. The ADI displays information regarding pitch-and-roll attitude, pitch-and-roll commands, and decision altitude (when used with a radar altimeter).

The HSI displays slaved gyro magnetic heading information, VOR/LOC/area navigation (RNAV) course deviation, and glide-slope deviation indications. The annunciator panel displays all vertical and lateral flight director/autopilot modes, including all “armed” modes prior to capture. Simply stated, it tells the pilot when the selected mode has been received and accepted by the system, and if an “armed” mode is selected, when capture has been initiated. It also has integral marker beacon lights and a trim failure warning.

A flight control guidance system that consists of either an autopilot with an approach coupler or a flight director system is required for Category II operations.

## Instrument Systems Preflight Procedures

Inspecting the instrument system requires a relatively small part of the total time required for preflight activities, but its importance cannot be overemphasized. Before any flight involving aircraft control by instrument reference, you should check all instruments and their sources of power for proper operation.

## Before Engine Start

1. Walk-around inspection—check the condition of all antennas and check the pitot tube for the presence of any obstructions and remove the cover. Check the static ports to be sure they are free from dirt and obstructions, and ensure there is nothing on the structure near the ports that would disturb the air flowing over them.
2. Aircraft records—confirm that the altimeter and static system has been checked and found within approved limits within the past 24-calendar months. Check the replacement date for the emergency locator transmitter (ELT) batteries noted in the maintenance record, and be sure they have been replaced within this time interval.
3. Preflight paperwork—check the Airport/Facility Directory (A/FD) and all Notices to Airmen (NOTAMs) for the condition and frequencies of all the navigation aids (NAVAIDs) that will be used on the flight. Handbooks, en route charts, approach charts, computer and flight log should be appropriate for the departure, en route, destination, and alternate airports.
4. Radio equipment—switches off.
5. Suction gauge—proper markings.
6. Airspeed indicator—proper reading.
7. Attitude indicator—uncaged, if applicable.
8. Altimeter—set the current altimeter setting and check that the pointers indicate the elevation of the airport.
9. Vertical speed indicator—zero indication.
10. Heading indicator—uncaged, if applicable.
11. Turn coordinator—miniature aircraft level, ball approximately centered (level terrain).
12. Magnetic compass—full of fluid and the correction card is in place and current.
13. Clock—set to the correct time.
14. Engine instruments—proper markings and readings.
15. Deicing and anti-icing equipment—check availability and fluid quantity.
16. Alternate static-source valve—be sure it can be opened if needed, and that it is fully closed.
17. Pitot tube heater—watch the ammeter when it is turned on, or by using the method specified in the POH/AFM.

### **After Engine Start**

1. When you turn the master switch on—listen to the gyros as they spin up. Any hesitation or unusual noises should be investigated before flight.
2. Suction gauge or electrical indicators—check the source of power for the gyro instruments. The suction developed should be appropriate for the instruments in that particular aircraft. If the gyros are electrically driven, check the generators and inverters for proper operation.
3. Magnetic compass—check the card for freedom of movement and confirm the bowl is full of fluid. Determine compass accuracy by comparing the indicated heading against a known heading (runway heading) while the airplane is stopped or taxiing straight. Remote indicating compasses should also be checked against known headings. Note the compass card correction for the takeoff runway heading.
4. Heading indicator—allow 5 minutes after starting engines for the gyro to spin up. Before taxiing, or while taxiing straight, set the heading indicator to correspond with the magnetic compass heading. A slaved gyro compass should be checked for slaving action and its indications compared with those of the magnetic compass.
5. Attitude indicator—allow the same time as noted above for gyros to spin up. If the horizon bar erects to the horizontal position and remains at the correct position for the attitude of the airplane, or if it begins to vibrate after this attitude is reached and then slowly stops vibrating altogether, the instrument is operating properly.
6. Altimeter—with the altimeter set to the current reported altimeter setting, note any variation between the known field elevation and the altimeter indication. If the variation is on the order of 75 feet, the accuracy of the altimeter is questionable and the problem should be referred to a repair station for evaluation and possible correction. Because the elevation of the ramp or hangar area might differ significantly from field elevation, recheck when in the runup area if the error exceeds 75 feet. When no altimeter setting is available, set the altimeter to the published field elevation during the preflight instrument check.

7. Vertical speed indicator—the instrument should read zero. If it does not, tap the panel gently. If it stays off the zero reading and is not adjustable, the ground indication will have to be interpreted as the zero position in flight.
8. Carburetor heat—check for proper operation and return to cold position.
9. Engine instruments—check for proper readings.
10. Radio equipment—check for proper operation and set as desired.
11. Deicing and anti-icing equipment—check operation.

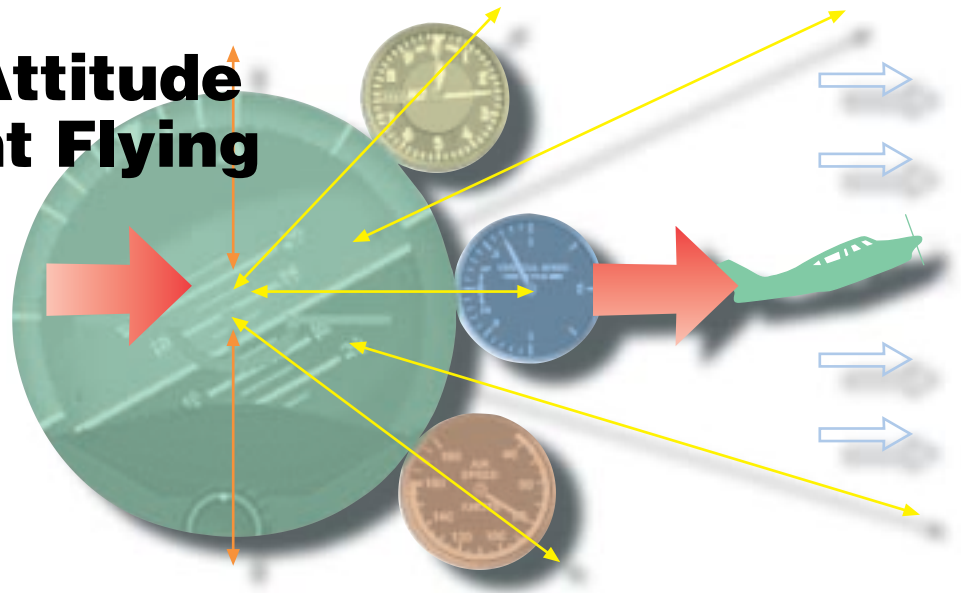
### **Taxiing and Takeoff**

1. Turn coordinator—during taxi turns, check the miniature aircraft for proper turn indications. The ball should move freely. The ball should move opposite to the direction of turns. The turn instrument should indicate in the direction of the turn. While taxiing straight, the miniature aircraft should be level.
2. Heading indicator—before takeoff, recheck the heading indicator. If your magnetic compass and deviation card are accurate, the heading indicator should show the known taxiway or runway direction when the airplane is aligned with them (within 5°).
3. Attitude indicator—if the horizon bar fails to remain in the horizontal position during straight taxiing, or tips in excess of 5° during taxi turns, the instrument is unreliable. Adjust the miniature aircraft with reference to the horizon bar for the particular airplane while on the ground. For some tricycle-gear airplanes, a slightly nose-low attitude on the ground will give a level flight attitude at normal cruising speed.

### **Engine Shut Down**

When shutting down the engine, note any abnormal instrument indications.

# Airplane Attitude Instrument Flying



## Introduction

**Attitude instrument flying** may be defined as the control of an aircraft's spatial position by using instruments rather than outside visual references.

Any flight, regardless of the aircraft used or route flown, consists of basic maneuvers. In visual flight, you control aircraft attitude with relation to the natural horizon by using certain reference points on the aircraft. In instrument flight, you control aircraft attitude by reference to the flight instruments. A proper interpretation of the flight instruments will give you essentially the same information that outside references do in visual flight. Once you learn the role of all the instruments in establishing and maintaining a desired aircraft attitude, you will be better equipped to control the aircraft in emergency situations involving failure of one or more key instruments.

Two basic methods used for learning attitude instrument flying are "control and performance" and "primary and supporting." Both methods involve the use of the same instruments, and both use the same responses for attitude control. They differ in their reliance on the attitude indicator and interpretation of other instruments.

### Attitude instrument flying:

Controlling the aircraft by reference to the instruments rather than outside visual cues.

## Control and Performance Method

Aircraft performance is achieved by controlling the aircraft attitude and power (angle of attack and thrust to drag relationship). Aircraft attitude is the relationship of its longitudinal and lateral axes to the Earth's horizon. An aircraft is flown in instrument flight by controlling the attitude and power, as necessary, to produce the desired performance. This is known as the control and performance method of attitude instrument flying and can be applied to any basic instrument maneuver. [Figure 4-1] The three general categories of instruments are control, performance, and navigation instruments.

### Control Instruments

The control instruments display immediate attitude and power indications and are calibrated to permit attitude and power adjustments in precise amounts. In this discussion, the term "power" is used in place of the more technically correct term "thrust or drag relationship." Control is determined by reference to the attitude indicator and power indicators. These power indicators vary with aircraft and may include tachometers, manifold pressure, engine pressure ratio, fuel flow, etc.

### Instrument flight fundamental:

$Attitude + Power = Performance$



**Figure 4-1.** Control/Performance cross-check method.

### Performance Instruments

The performance instruments indicate the aircraft's actual performance. Performance is determined by reference to the altimeter, airspeed or Mach indicator, vertical speed indicator, heading indicator, angle-of-attack indicator, and turn-and-slip indicator.

### Navigation Instruments

The navigation instruments indicate the position of the aircraft in relation to a selected navigation facility or fix. This group of instruments includes various types of course indicators, range indicators, glide-slope indicators, and bearing pointers.

### Procedural Steps

1. **Establish**—Establish an attitude and power setting on the control instruments that will result in the desired performance. Known or computed attitude changes and approximate power settings will help to reduce the pilot's workload.
2. **Trim**—Trim until control pressures are neutralized. Trimming for hands-off flight is essential for smooth, precise aircraft control. It allows pilots to divert their attention to other cockpit duties with minimum deviation from the desired attitude.

**Trim:** Adjusting the aerodynamic forces on the control surfaces so that the aircraft maintains the set attitude without any control input.

3. Cross-check—Cross-check the performance instruments to determine if the established attitude or power setting is providing the desired performance. The cross-check involves both seeing and interpreting. If a deviation is noted, determine the magnitude and direction of adjustment required to achieve the desired performance.
4. Adjust—Adjust the attitude or power setting on the control instruments as necessary.

### **Attitude Control**

Proper control of aircraft attitude is the result of maintaining a constant attitude, knowing when and how much to change the attitude, and smoothly changing the attitude a precise amount. Aircraft attitude control is accomplished by properly using the attitude indicator. The attitude reference provides an immediate, direct, and corresponding indication of any change in aircraft pitch or bank attitude.

#### *Pitch Control*

Pitch changes are made by changing the “pitch attitude” of the miniature aircraft or fuselage dot by precise amounts in relation to the horizon. These changes are measured in degrees or fractions thereof, or bar widths depending upon the type of attitude reference. The amount of deviation from the desired performance will determine the magnitude of the correction.

#### *Bank Control*

Bank changes are made by changing the “bank attitude” or bank pointers by precise amounts in relation to the bank scale. The bank scale is normally graduated at 0°, 10°, 20°, 30°, 60°, and 90° and may be located at the top or bottom of the attitude reference. Normally, use a bank angle that approximates the degrees to turn, not to exceed 30°.

### **Power Control**

Proper power control results from the ability to smoothly establish or maintain desired airspeeds in coordination with attitude changes. Power changes are made by throttle adjustments and reference to the power indicators. Power indicators are not affected by such factors as turbulence, improper trim, or inadvertent control pressures. Therefore, in most aircraft little attention is required to ensure the power setting remains constant.

From experience in an aircraft, you know approximately how far to move the throttles to change the power a given amount. Therefore, you can make power changes primarily by throttle movement and then cross-check the indicators to establish a more precise setting. The key is to avoid **fixating** on the indicators while setting the power. A knowledge of approximate power settings for various **flight configurations** will help you avoid overcontrolling power.

### **Primary and Supporting Method**

Another basic method for presenting attitude instrument flying classifies the instruments as they relate to control function as well as aircraft performance. All maneuvers involve some degree of motion about the lateral (pitch), longitudinal (bank/roll), and vertical (yaw) axes. Attitude control is stressed in this handbook in terms of pitch control, bank control, power control, and trim control. [Figure 4-2] Instruments are grouped as they relate to control function and aircraft performance as follows:

#### **Pitch Instruments**

- Attitude Indicator
- Altimeter
- Airspeed Indicator
- Vertical Speed Indicator

#### **Bank Instruments**

- Attitude Indicator
- Heading Indicator
- Magnetic Compass
- Turn Coordinator

#### **Power Instruments**

- Airspeed Indicator
- Engine Instruments
  - Manifold Pressure Gauge (MP)
  - Tachometer/RPM
  - Engine Pressure Ratio (EPR)—Jet

For any maneuver or condition of flight, the pitch, bank, and power control requirements are most clearly indicated by certain key instruments. The instruments that provide the most pertinent and essential information will be referred to as primary instruments. Supporting instruments back up and supplement the information shown on the primary

**Fixating:** Staring at a single instrument, thereby interrupting the cross-check process.

**Flight configurations:** Adjusting the aircraft controls surfaces (including flaps and landing gear) in a manner that will achieve a specified attitude.





**Figure 4-2.** Primary/Supporting cross-check method.

instruments. Straight-and-level flight at a constant airspeed, for example, means that an exact altitude is to be maintained with zero bank (constant heading) at a constant airspeed. The pitch, bank, and power instruments that tell you whether you are maintaining this flight condition are the:

1. Altimeter—supplies the most pertinent altitude information and is therefore primary for pitch.
2. Heading Indicator—supplies the most pertinent bank or heading information, and is primary for bank.

3. Airspeed Indicator—supplies the most pertinent information concerning performance in level flight in terms of power output, and is primary for power.

Although the attitude indicator is the basic attitude reference, this concept of primary and supporting instruments does not devalue any particular flight instrument. It is the only instrument that portrays instantly and directly the actual flight attitude. It should always be used, when available, in establishing and maintaining pitch-and-bank attitudes. You will better understand the specific use of primary and supporting instruments when the basic instrument maneuvers are presented in detail in Chapter 5, “Airplane Basic Flight Maneuvers.”

You will find the terms “direct indicating instrument” and “indirect indicating instrument” used in the following pages. A “direct” indication is the true and instantaneous reflection of airplane pitch-and-bank attitude by the miniature aircraft relative to the horizon bar of the attitude indicator. The altimeter, airspeed indicator, and vertical speed indicator give supporting (“indirect”) indications of pitch attitude at a given power setting. The heading indicator and turn needle give supporting indications for bank attitude.

## Fundamental Skills

During attitude instrument training, you must develop three fundamental skills involved in all instrument flight maneuvers: instrument cross-check, instrument interpretation, and aircraft control. Although you learn these skills separately and in deliberate sequence, a measure of your proficiency in precision flying will be your ability to integrate these skills into unified, smooth, positive control responses to maintain any prescribed flight path.

### Cross-Check

The first fundamental skill is cross-checking (also called “scanning” or “instrument coverage”). Cross-checking is the continuous and logical observation of instruments for attitude and performance information. In attitude instrument flying, the pilot maintains an attitude by reference to instruments that will produce the desired result in performance. Due to human error, instrument error, and airplane performance differences in various atmospheric and loading conditions, it is impossible to establish an attitude and have performance remain constant for a long period of time. These variables make it necessary for the pilot to constantly check the instruments and make appropriate changes in airplane attitude.

#### Selected Radial Cross-Check

When you use the selected radial cross-check, your eyes spend 80 to 90 percent of the time looking at the attitude indicator, leaving it only to take a quick glance at one of the flight instruments (for this discussion, the five instruments surrounding the attitude indicator will be called the flight instruments). With this method, your eyes never travel directly between the flight instruments but move by way of the attitude indicator. The maneuver being performed determines which instruments to look at in the pattern. [Figure 4-3]



**Figure 4-3.** Selected radial cross-check pattern.

#### Inverted-V Cross-Check

Moving your eyes from the attitude indicator down to the turn instrument, up to the attitude indicator, down to the vertical speed indicator, and back up to the attitude indicator is called the inverted-V cross-check. [Figure 4-4]



**Figure 4-4.** Inverted-V cross-check.

#### The Rectangular Cross-Check

If you move your eyes across the top three instruments (airspeed indicator, attitude indicator, and altimeter) and drop them down to scan the bottom three instruments (vertical speed indicator, heading indicator, and turn instrument), their path will describe a rectangle (clockwise or counterclockwise rotation is a personal choice). [Figure 4-5]

This cross-checking method gives equal weight to the information from each instrument, regardless of its importance to the maneuver being performed. However, this method lengthens the time it takes for your eyes to return to an instrument critical to the successful completion of the maneuver.



**Figure 4-5.** Rectangular cross-check pattern.

### Common Cross-Check Errors

As a beginner, you might cross-check rapidly, looking at the instruments without knowing exactly what you are looking for. With increasing experience in basic instrument maneuvers and familiarity with the instrument indications associated with them, you will learn what to look for, when to look for it, and what response to make. As proficiency increases, you cross-check primarily from habit, suiting your scanning rate and sequence to the demands of the flight situation.

You can expect to make many of the following common scanning errors, both during training and at any subsequent time, if you fail to maintain basic instrument proficiency through practice:

1. Fixation, or staring at a single instrument, usually occurs for a good reason, but has poor results. For instance, you may find yourself staring at your altimeter, which reads 200 feet below the assigned altitude, wondering how the needle got there. While you gaze at the instrument, perhaps with increasing **tension** on the controls, a heading change occurs unnoticed, and more errors accumulate.

**Tension:** Maintaining an excessively strong grip on the control column; usually results in an overcontrolled situation.

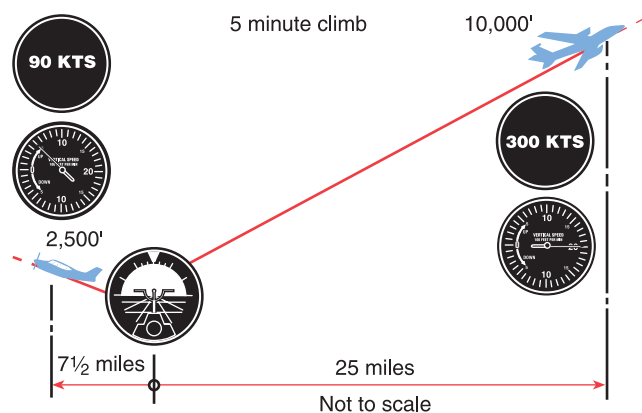
Another common fixation is likely when you initiate an attitude change. For example, you establish a shallow bank for a 90° turn and stare at the heading indicator throughout the turn, instead of maintaining your cross-check of other pertinent instruments. You know the aircraft is turning and you do not need to recheck the heading indicator for approximately 25 seconds after turn entry, yet you cannot take your eyes off the instrument. The problem here may not be entirely due to cross-check error. It may be related to difficulties with one or both of the other fundamental skills. You may be fixating because of uncertainty about reading the heading indicator (interpretation), or because of inconsistency in rolling out of turns (control).

2. Omission of an instrument from your cross-check is another likely fault. It may be caused by failure to anticipate significant instrument indications following attitude changes. For example, on your roll-out from a 180° steep turn, you establish straight-and-level flight with reference to the attitude indicator alone, neglecting to check the heading indicator for constant heading information. Because of precession error, the attitude indicator will temporarily show a slight error, correctable by quick reference to the other flight instruments.
3. Emphasis on a single instrument, instead of on the combination of instruments necessary for attitude information, is an understandable fault during the initial stages of training. You naturally tend to rely on the instrument that you understand most readily, even when it provides erroneous or inadequate information. Reliance on a single instrument is poor technique. For example, you can maintain reasonably close altitude control with the attitude indicator, but you cannot hold altitude with precision without including the altimeter in your cross-check.

### Instrument Interpretation

The second fundamental skill, instrument interpretation, requires the most thorough study and analysis. It begins as you understand each instrument's construction and operating principles. Then you must apply this knowledge to the performance of the aircraft that you are flying, the particular maneuvers to be executed, the cross-check and control techniques applicable to that aircraft, and the flight conditions in which you are operating.

For example, a pilot uses full power in a small airplane for a 5-minute climb from near sea level, and the attitude indicator shows the miniature aircraft two bar widths (twice the thickness of the miniature aircraft wings) above the artificial horizon. [Figure 4-6] The airplane is climbing at 500 feet per minute (fpm) as shown on the vertical speed indicator, and at an airspeed of 90 knots, as shown on the airspeed indicator. With the power available in this particular airplane and the attitude selected by the pilot, the performance is shown on the instruments.



**Figure 4-6.** Power and attitude equal performance.

Now set up the identical picture on the attitude indicator in a jet airplane. With the same airplane attitude as shown in the first example, the vertical speed indicator in the jet reads 2,000 fpm, and the airspeed indicates 300 knots. As you learn the performance capabilities of the aircraft in which you are training, you will interpret the instrument indications appropriately in terms of the attitude of the aircraft. If the pitch attitude is to be determined, the airspeed indicator, altimeter, vertical speed indicator, and attitude indicator provide the necessary information. If the bank attitude is to be determined, the heading indicator, turn coordinator, and attitude indicator must be interpreted.

For each maneuver, you will learn what performance to expect and the combination of instruments you must interpret in order to control aircraft attitude during the maneuver.

## Aircraft Control

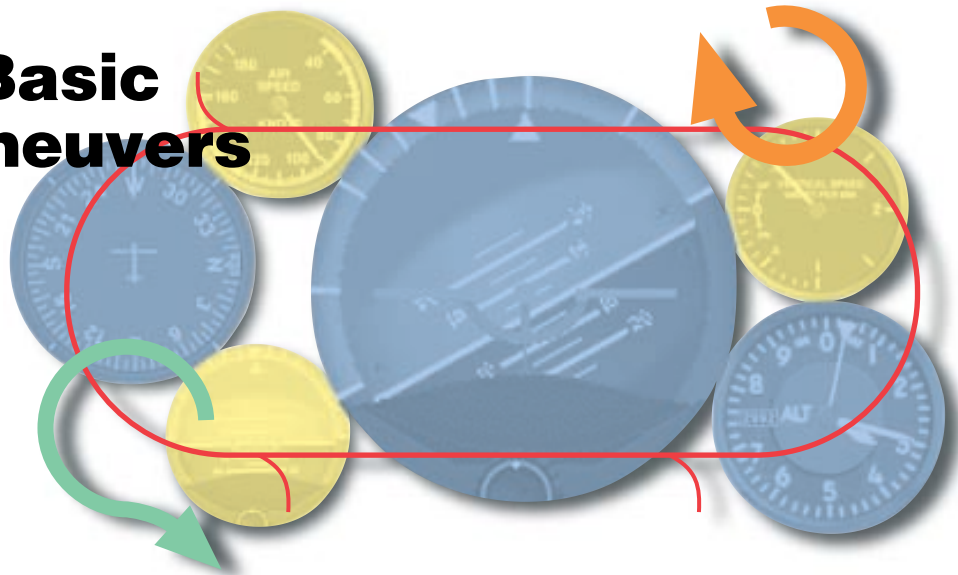
The third fundamental instrument flying skill is aircraft control. When you use instruments as substitutes for outside references, the necessary control responses and thought processes are the same as those for controlling aircraft performance by means of outside references. Knowing the desired attitude of the aircraft with respect to the natural and artificial horizon, you maintain the attitude or change it by moving the appropriate controls.

Aircraft control is composed of four components: pitch control, bank control, power control, and trim.

1. Pitch control is controlling the rotation of the aircraft about the lateral axis by movement of the elevators. After interpreting the pitch attitude from the proper flight instruments, you exert control pressures to effect the desired pitch attitude with reference to the horizon.
2. Bank control is controlling the angle made by the wing and the horizon. After interpreting the bank attitude from the appropriate instruments, you exert the necessary pressures to move the ailerons and roll the aircraft about the longitudinal axis.
3. Power control is used when interpretation of the flight instruments indicates a need for a change in thrust.
4. Trim is used to relieve all control pressures held after a desired attitude has been attained. An improperly trimmed aircraft requires constant control pressures, produces tension, distracts your attention from cross-checking, and contributes to abrupt and erratic attitude control. The pressures you feel on the controls must be those you apply while controlling a planned change in aircraft attitude, not pressures held because you let the aircraft control you.



# Airplane Basic Flight Maneuvers



## Introduction

Instrument flying **techniques** differ according to aircraft type, class, performance capability, and instrumentation. Therefore, the procedures and techniques that follow will need to be modified for application to different types of aircraft. Recommended procedures, performance data, operating limitations, and flight characteristics of a particular aircraft are available in your Pilot's Operating Handbook/Airplane Flight Manual (POH/AFM) for study before practicing the flight maneuvers.

The flight maneuvers discussed here assume the use of a single-engine, propeller-driven **small airplane** with retractable gear and flaps and a panel with instruments representative of those discussed earlier in Chapter 3, "Flight Instruments." With the exception of the instrument takeoff, all of the maneuvers can be performed on "partial panel," with the attitude gyro and heading indicator covered or inoperative.

## Straight-and-Level Flight

### Pitch Control

The pitch attitude of an airplane is the angle between the longitudinal axis of the airplane and the actual horizon. In level flight, the pitch attitude varies with airspeed and load. For training purposes, the latter factor can normally be disregarded in small airplanes. At a constant airspeed, there

is only one specific pitch attitude for level flight. At slow cruise speeds, the level-flight attitude is nose-high; at fast cruise speeds, the level-flight attitude is nose-low. [Figures 5-1 and 5-2] Figure 5-3 shows the attitude at normal cruise speeds.

The pitch instruments are the attitude indicator, the altimeter, the vertical speed indicator, and the airspeed indicator.

### Attitude Indicator

The attitude indicator gives you a **direct indication** of pitch attitude. You attain the desired pitch attitude by using the elevator control to raise or lower the miniature aircraft in relation to the horizon bar. This corresponds to the way you adjust pitch attitude in visual flight by raising or lowering the nose of the airplane in relation to the natural horizon. However, unless the airspeed is constant, and until you have established and identified the level-flight attitude for that airspeed, you have no way of knowing whether level flight, as indicated on the attitude indicator, is resulting in level flight as shown on the altimeter, vertical speed indicator, and airspeed indicator. If the miniature aircraft of the attitude indicator is properly adjusted on the ground before takeoff, it will show approximately level flight at normal cruise speed when you complete your level-off from a climb. If further adjustment of the miniature aircraft is necessary, the other pitch instruments must be used to maintain level flight while the adjustment is made.

**Technique:** The manner or style in which the procedures are executed.

**Small airplane:** An airplane of 12,500 pounds or less maximum certificated takeoff weight.

**Direct indication:** The true and instantaneous reflection of aircraft pitch-and-bank attitude by the miniature aircraft, relative to the horizon bar of the attitude indicator.



**Figure 5-1.** Pitch attitude and airspeed in level flight, slow cruise speed.



**Figure 5-2.** Pitch attitude and airspeed in level flight, fast cruise speed.



**Figure 5-3.** Pitch attitude and airspeed in level flight, normal cruise speed.

In practicing pitch control for level flight using only the attitude indicator, restrict the displacement of the horizon bar to a bar width up or down, a half-bar width, then a one-and-one-half bar width. Half-, two-, and three-bar-width nose-high attitudes are shown in figures 5-4, 5-5, and 5-6.

Your instructor pilot may demonstrate these normal pitch corrections while you compare the indications on the attitude indicator with the airplane's position to the natural horizon.

Pitch attitude changes for corrections to level flight by reference to instruments are much smaller than those commonly used for visual flight. With the airplane correctly trimmed for level flight, the elevator displacement and the **control pressures** necessary to effect these standard pitch changes are usually very slight. Following are a few helpful hints to help you determine how much elevator control pressure is required.



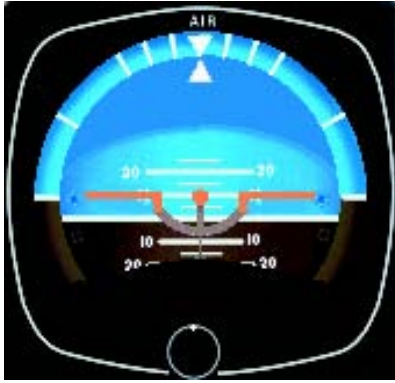
**Figure 5-4.** Pitch correction for level flight, half-bar width.



**Figure 5-5.** Pitch correction for level flight, two-bar width.

**Control pressures:** The amount of physical exertion on the control column necessary to achieve the desired aircraft attitude.





**Figure 5-6.** Pitch correction for level flight, three-bar width.

First, a tight grip on the controls makes it difficult to feel control pressure changes. Relaxing and learning to control “with your eyes and your head” instead of your muscles usually takes considerable conscious effort during the early stages of instrument training.

Second, make smooth and small pitch changes with a positive pressure. Practice these small corrections until you can make pitch corrections up or down, “freezing” (holding constant) the one-half, full, and one-and-one-half bar widths on the attitude indicator.

Third, with the airplane properly trimmed for level flight, momentarily release all of your pressure on the elevator control when you become aware of tenseness. This will remind you that the airplane is stable; except under turbulent conditions, it will maintain level flight if you leave it alone. Even when your eyes tell you that no control change is called for, it will be difficult to resist the impulse to move the controls. This may prove to be one of your most difficult initial training problems.

### Altimeter

At constant power, any deviation from level flight (except in turbulent air) must be the result of a pitch change. Therefore, the altimeter gives an **indirect indication** of the pitch attitude in level flight, assuming constant power. Since the altitude should remain constant when the airplane is in level flight, any deviation from the desired altitude signals the need for a pitch change. If you are gaining altitude, the nose must be lowered. [Figures 5-7 and 5-8]

**Indirect indication:** A reflection of aircraft pitch-and-bank attitude by the instruments other than the attitude indicator.



**Figure 5-7.** Using the altimeter for pitch interpretation, a high altitude means a nose-high pitch attitude.



**Figure 5-8.** Pitch correction following altitude increase—lower nose to correct altitude error.

The rate of movement of the altimeter needle is as important as its direction of movement for maintaining level flight without the use of the attitude indicator. An excessive pitch deviation from level flight results in a relatively rapid change of altitude; a slight pitch deviation causes a slow change. Thus, if the altimeter needle moves rapidly clockwise, assume a considerable nose-high deviation from level-flight attitude. Conversely, if the needle moves slowly counterclockwise to indicate a slightly nose-low attitude, assume that the pitch correction necessary to regain the desired altitude is small. As you add the altimeter to the attitude indicator in your cross-check, you will learn to recognize the rate of movement of the altimeter needle for a given pitch change as shown on the attitude indicator.

If you are practicing precision control of pitch in an airplane without an attitude indicator, make small pitch changes by visual reference to the natural horizon, and note the rate of movement of the altimeter. Note what amount of pitch change gives the slowest steady rate of change on the altimeter. Then

practice small pitch corrections by accurately interpreting and controlling the rate of needle movement.

Your instructor pilot may demonstrate an excessive nose-down deviation (indicated by rapid movement of the altimeter needle) and then, as an example, show you the result of improper corrective technique. The normal impulse is to make a large pitch correction in a hurry, but this inevitably leads to **overcontrolling**. The needle slows down, then reverses direction, and finally indicates an excessive nose-high deviation. The result is tension on the controls, erratic control response, and increasingly extreme control movements. The correct technique, which is slower and smoother, will return the airplane to the desired altitude more quickly, with positive control and no confusion.

When a pitch error is detected, corrective action should be taken promptly, but with light control pressures and two distinct changes of attitude: (1) a change of attitude to stop the needle movement, and (2) a change of attitude to return to the desired altitude.

When you observe that the needle movement indicates an altitude deviation, apply just enough elevator pressure to slow down the rate of needle movement. If it slows down abruptly, ease off some of the pressure until the needle continues to move, but slowly. Slow needle movement means your airplane attitude is close to level flight. Add a little more corrective pressure to stop the direction of needle movement. At this point you are in level flight; a reversal of needle movement means you have passed through it. Relax your control pressures carefully as you continue to cross-check, since changing airspeed will cause changes in the effectiveness of a given control pressure. Next, adjust the pitch attitude with elevator pressure for the rate of change of altimeter needle movement that you have correlated with normal pitch corrections, and return to the desired altitude.

As a rule of thumb, for errors of less than 100 feet, use a half-bar-width correction. [Figures 5-9 and 5-10] For errors in excess of 100 feet, use an initial full-bar-width correction. [Figures 5-11 and 5-12]

Practice predetermined altitude changes using the altimeter alone, then in combination with the attitude indicator.

**Overcontrolling:** Using more movement in the control column than is necessary to achieve the desired pitch-and-bank condition.



**Figure 5-9.** Altitude error, less than 100 feet.



**Figure 5-10.** Pitch correction, less than 100 feet—1/2 bar low to correct altitude error.



**Figure 5-11.** Altitude error, greater than 100 feet.



**Figure 5-12.** Pitch correction, greater than 100 feet—1 bar correction initially.

### Vertical Speed Indicator

The vertical speed indicator gives an indirect indication of pitch attitude and is both a **trend** and a rate instrument. As a trend instrument, it shows immediately the initial vertical movement of the airplane, which, disregarding turbulence, can be considered a reflection of pitch change. To maintain level flight, use the vertical speed indicator in conjunction with the altimeter and attitude indicator. Note any “up” or “down” trend of the needle from zero and apply a very light corrective elevator pressure. As the needle returns to zero, relax the corrective pressure. If your control pressures have been smooth and light, the needle will react immediately and slowly, and the altimeter will show little or no change of altitude.

Used as a rate instrument, the **lag** characteristics of the vertical speed indicator must be considered.

Lag refers to the delay involved before the needle attains a stable indication following a pitch change. Lag is directly proportional to the speed and magnitude of a pitch change. If a slow, smooth pitch change is initiated, the needle will move with minimum lag to a point of deflection corresponding to the extent of the pitch change, and then stabilize as the aerodynamic forces are balanced in the climb or descent. A large and abrupt pitch change will produce erratic needle movement, a reverse indication, and introduce greater time delay (lag) before the needle stabilizes. Pilots are cautioned not to chase the needle when flight through turbulent conditions produces erratic needle movements.

When using the vertical speed indicator as a rate instrument and combining it with the altimeter and attitude indicator to maintain level flight, keep this in mind: the amount the altimeter has moved from the desired altitude governs the rate at which you should return to that altitude. A rule of thumb is to make an attitude change that will result in a vertical-speed rate approximately double your error in altitude. For example, if altitude is off by 100 feet, your rate of return should be approximately 200 feet per minute (fpm). If it is off more than 100 feet, the correction should be correspondingly greater, but should never exceed the optimum rate of climb or descent for your airplane at a given airspeed and configuration.

**Trend:** Instruments showing an immediate indication of the direction of aircraft movement.

**Lag:** The delay that occurs before an instrument needle attains a stable indication.

A deviation more than 200 fpm from the desired rate of return is considered overcontrolling. For example, if you are attempting to return to an altitude at a rate of 200 fpm, a rate in excess of 400 fpm indicates overcontrolling.

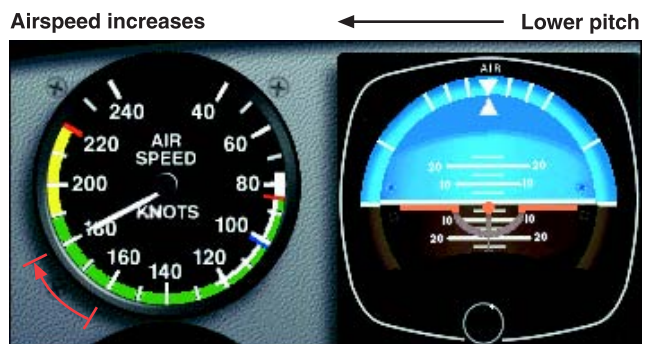
When you are returning to an altitude, the vertical speed indicator is the primary pitch instrument. Occasionally, the vertical speed indicator is slightly out of calibration and may indicate a climb or descent when the airplane is in level flight. If you cannot adjust the instrument, you must take the error into consideration when using it for pitch control. For example, if the needle indicates a descent of 200 fpm while in level flight, use this indication as the zero position.

### Airspeed Indicator

The airspeed indicator presents an indirect indication of the pitch attitude. At a constant power setting and pitch attitude, airspeed remains constant. [Figure 5-13] As the pitch attitude lowers, airspeed increases, and the nose should be raised. [Figure 5-14] As the pitch attitude rises, airspeed decreases,

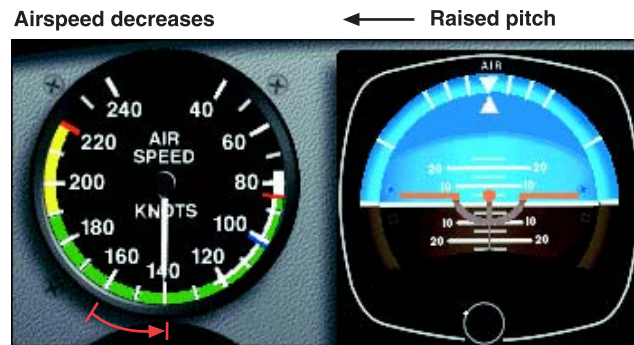


**Figure 5-13.** Constant power plus constant pitch equals constant airspeed.



**Figure 5-14.** Constant power plus decreased pitch equals increased airspeed.

and the nose should be lowered. [Figure 5-15] A rapid change in airspeed indicates a large pitch change, and a slow change of airspeed indicates a small pitch change.



**Figure 5-15.** Constant power plus increased pitch equals decreased airspeed.

The apparent lag in airspeed indications with pitch changes varies greatly among different airplanes and is due to the time required for the airplane to accelerate or decelerate when the pitch attitude is changed. There is no appreciable lag due to the construction or operation of the instrument. Small pitch changes, smoothly executed, result in an immediate change of airspeed.

Pitch control in level flight is a question of cross-check and interpretation of the instrument panel for the instrument information that will enable you to visualize and control pitch attitude. Regardless of individual differences in cross-check technique, all pilots should use the instruments that give the best information for controlling the airplane in any given maneuver. Pilots should also check the other instruments to aid in maintaining the important, or primary, instruments at the desired indication.

As noted previously, the primary instrument is the one that gives the most pertinent information for any particular maneuver. It is usually the one you should hold at a constant indication. Which instrument is primary for pitch control in level flight, for example? This question should be considered in the context of specific airplane, weather conditions, pilot

experience, operational conditions, and other factors. Attitude changes must be detected and interpreted instantly for immediate control action in high-performance airplanes. On the other hand, a reasonably proficient instrument pilot in a slower airplane may rely more on the altimeter for primary pitch information, especially if it is determined that too much reliance on the attitude indicator fails to provide the necessary precise attitude information. Whether the pilot decides to regard the altimeter or the attitude indicator as primary depends on which approach will best help control the attitude.

In this handbook, the altimeter is normally considered as the primary pitch instrument during level flight.

### Bank Control

The bank attitude of an airplane is the angle between the lateral axis of the airplane and the natural horizon. To maintain a straight-and-level flight path, you must keep the wings of the airplane level with the horizon (assuming the airplane is in **coordinated** flight). Any deviation from straight flight resulting from bank error should be corrected by coordinated aileron and rudder pressure.

The instruments used for bank control are the attitude indicator, the heading indicator, and the turn coordinator. [Figure 5-16]

### Attitude Indicator

The attitude indicator shows any change in bank attitude directly and instantly. On the standard attitude indicator, the angle of bank is shown pictorially by the relationship of the miniature aircraft to the artificial horizon bar, and by the alignment of the pointer with the banking scale at the top of the instrument. On the face of the standard 3-inch instrument, small angles of bank can be difficult to detect by reference to the miniature aircraft, especially if you lean to one side or move your seating position slightly. The position of the scale pointer is a good check against the apparent miniature aircraft position. Disregarding **precession error**, small deviations from straight coordinated flight can be readily detected on the scale pointer. The banking index may be graduated as shown in figure 5-17, or it may lack the 10° and 20° indexes.

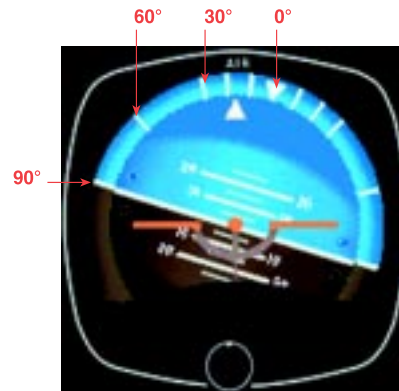
**Coordinated:** Using the controls to maintain or establish various conditions of flight with (1) a minimum disturbance of the forces maintaining equilibrium, or (2) the control action necessary to effect the smoothest changes in equilibrium.

**Precession error:** The result of the force applied to a spinning gyroscope felt not at the point the force is applied, but at a point 90° in the direction of rotation from that point.



**Figure 5-16.** Instruments used for bank control.

The instrument depicted in figure 5-17 has a scale pointer that moves in the same direction of bank shown by the miniature aircraft. On some attitude indicators, the scale pointer moves in a direction opposite to the direction of bank shown by the miniature aircraft. A bank indication of 30° to the right of the zero, or nose position, indicates a 30° left banking attitude. Errors due to the construction of this instrument are common and predictable, but the obvious advantage of the attitude indicator is that you get an immediate indication of both pitch attitude and bank attitude in a single glance. Even with the precession errors associated with many attitude indicators, the quick attitude presentation requires less visual effort and time for positive control than other flight instruments.



**Figure 5-17.** Bank interpretation with the attitude indicator.

### Heading Indicator

The bank attitude of an aircraft in coordinated flight is shown indirectly on the heading indicator, since banking results in a turn and change in heading. Assuming the same airspeed in both instances, a rapid movement of the heading indicator needle (or azimuth card in a directional gyro) indicates a large angle of bank, whereas a slow movement of the needle or card reflects a small angle of bank. If you note the rate of

movement of the heading indicator and compare it to the attitude indicator's degrees of bank, you will learn to look for important bank information on the heading indicator. This is especially the case when the attitude indicator's precession error makes a precise check of heading information necessary in order to maintain straight flight.

When you note deviations from straight flight on the heading indicator, make your correction to the desired heading using a bank angle no greater than the number of degrees to be turned. In any case, limit your bank corrections to a bank angle no greater than that required for a standard-rate turn. Use of larger bank angles requires a very high level of proficiency, and normally results in overcontrolling and erratic bank control.

### *Turn Coordinator*

The miniature aircraft of the turn coordinator gives you an indirect indication of the bank attitude of the airplane. When the miniature aircraft is level, the airplane is in straight flight. If the ball is centered, a left deflection of the miniature aircraft means the left wing is low and the airplane is in a left turn. Thus, when the miniature aircraft is in a stabilized deflection, the airplane is turning in the direction indicated. Return to straight flight is accomplished by coordinated aileron and rudder pressure to level the miniature aircraft. Include the miniature aircraft in your cross-check and correct for even the smallest deviations from the desired position. When the instrument is used to maintain straight flight, control pressures must be applied very lightly and smoothly.

The ball of the turn coordinator is actually a separate instrument, conveniently located under the miniature aircraft because the two instruments are used together. The ball instrument indicates the quality of the turn. If the ball is off center, the airplane is slipping or skidding, and the miniature aircraft under these conditions shows an error in bank attitude. Figures 5-18 and 5-19 show the instrument indications for slips and skids, respectively. If the wings are level and the airplane is properly trimmed, the ball will remain in the center, and the airplane will be in straight flight. If the ball is not centered, the airplane is improperly trimmed (or you are holding rudder pressure against proper trim).



**Figure 5-18.** Slip indication.



**Figure 5-19.** Skid indication.

To maintain straight-and-level flight with proper trim, note the direction of ball displacement. If the ball is to the left of center and the left wing is low, apply left rudder pressure (or release right rudder pressure if you are holding it) to center the ball and correct the slip. At the same time apply right aileron pressure as necessary to level the wings, cross-checking the heading indicator and attitude indicator as you center the ball. If the wings are level and the ball is displaced from the center, the airplane is skidding. Note the direction of ball displacement, and use the same corrective technique as for an indicated slip. Center the ball (left ball/left rudder, right ball/right rudder), use aileron as necessary for bank control, and retrim.

To trim the airplane using only the turn coordinator, use aileron pressure to level the miniature aircraft and rudder pressure to center the ball. Hold these indications with control pressures, gradually releasing them as you apply rudder trim sufficient to relieve all rudder pressure. Apply aileron trim, if available, to relieve aileron pressure. With a full instrument panel, maintain a wings-level attitude by reference to all available instruments while you trim the airplane.

### **Power Control**

Power produces thrust which, with the appropriate angle of attack of the wing, overcomes the forces of gravity, drag, and inertia to determine airplane performance.

Power control must be related to its effect on altitude and airspeed, since any change in power setting results in a change in the airspeed or the altitude of the airplane. At any given airspeed, the power setting determines whether the airplane is in level flight, in a climb, or in a descent. If you increase the power while in straight-and-level flight and hold the

airspeed constant, the airplane will climb; and if you decrease the power while holding the airspeed constant, the airplane will descend. On the other hand, if you hold altitude constant, the power applied will determine the airspeed.

The relationship between altitude and airspeed determines the need for a change in pitch or power. If the airspeed is off the desired value, always check the altimeter before deciding that a power change is necessary. If you think of altitude and airspeed as interchangeable, you can trade altitude for airspeed by lowering the nose, or convert airspeed to altitude by raising the nose. If your altitude is higher than desired and your airspeed is low, or vice versa, a change in pitch alone may return the airplane to the desired altitude and airspeed. [Figure 5-20] If both airspeed and altitude are high or if both are low, then a change in both pitch and power is necessary in order to return to the desired airspeed and altitude. [Figure 5-21]

For changes in airspeed in straight-and-level flight, pitch, bank, and power must be coordinated in order to maintain constant altitude and heading. When power is changed to vary airspeed in straight-and-level flight, a single-engine, propeller-driven airplane tends to change attitude around all axes of movement. Therefore, to maintain constant altitude and heading, you will need to apply various control pressures in proportion to the change in power. When you add power to increase airspeed, the pitch instruments will show a climb unless you apply forward-elevator control pressure as the airspeed changes. When you increase power, the airplane tends to yaw and roll to the left unless you apply counteracting aileron and rudder pressures. Keeping ahead of these changes requires an increase in your cross-check speed, which varies with the type of airplane and its torque characteristics, the extent of power and speed change involved, and your technique in making the power change.



**Figure 5-20.** *Airspeed low and altitude high (lower pitch).*



**Figure 5-21.** *Airspeed and altitude high (lower pitch and reduce power).*

## Power Settings

Power control and airspeed changes are much easier when you know in advance the approximate power settings necessary to maintain various airspeeds in straight-and-level flight. However, to change airspeed any appreciable amount, the common procedure is to **underpower** or **overpower** on initial power changes to accelerate the rate of airspeed change. (For small speed changes, or in airplanes that decelerate or accelerate rapidly, overpowering or underpowering is not necessary.)

Consider the example of an airplane that requires 23 inches of manifold pressure to maintain a normal cruising airspeed of 140 knots, and 18 inches of manifold pressure to maintain an airspeed of 100 knots. The reduction in airspeed from 140 knots to 100 knots while maintaining straight-and-level flight is discussed below and illustrated in figures 5-22, 5-23, and 5-24.

Instrument indications, prior to the power reduction, are shown in figure 5-22. The basic attitude is established and maintained on the attitude indicator, and the specific pitch, bank, and power control requirements are detected on these primary instruments:

Altimeter—Primary Pitch

Heading Indicator—Primary Bank

Airspeed Indicator—Primary Power

Supporting pitch-and-bank instruments are shown in the illustrations. The supporting power instrument is the manifold pressure gauge (or tachometer if the propeller is fixed-pitch).

As you make a smooth power reduction to approximately 15" Hg (underpower), the manifold pressure gauge becomes the primary power instrument. [Figure 5-23] With practice, you will be able to change a power setting with only a brief glance at the power instrument, by sensing the movement of the throttle, the change in sound, and the changes in the feel of control pressures.



**Figure 5-22.** Straight-and-level flight (normal cruising speed).

**Underpower:** Using less power than required for the purpose of achieving a faster rate of airspeed change.

**Overpower:** Using more power than required for the purpose of achieving a faster rate of airspeed change.





**Figure 5-23.** Straight-and-level flight (airspeed decreasing).

As the thrust decreases, increase the speed of your cross-check and be ready to apply left rudder, back-elevator, and aileron control pressure the instant the pitch-and-bank instruments show a deviation from altitude and heading. As you become proficient, you will learn to cross-check, interpret, and control the changes with no deviation of heading and altitude. Assuming smooth air and ideal control technique, as airspeed decreases, a proportionate increase in airplane pitch attitude is required to maintain altitude. Similarly, effective torque control means counteracting yaw with rudder pressure.

As the power is reduced, the altimeter is primary for pitch, the heading indicator is primary for bank, and the manifold pressure gauge is momentarily primary for power (at 15" Hg in this example). Control pressures should be trimmed off as the airplane decelerates. As the airspeed approaches the desired airspeed of 100 knots, the manifold pressure is adjusted to approximately 18" Hg and becomes the supporting power instrument. The airspeed indicator again becomes primary for power. [Figure 5-24]

### *Airspeed Changes in Straight-and-Level Flight*

Practice of airspeed changes in straight-and-level flight provides an excellent means of developing increased proficiency in all three basic instrument skills, and brings out some common errors to be expected during training in straight-and-level flight. Having learned to control the airplane in a **clean configuration** (minimum drag conditions), you can increase your proficiency in cross-check and control by practicing speed changes while extending or retracting the flaps and landing gear. While practicing, be sure you comply with the airspeed limitations specified in your POH/AFM for gear and flap operation.

Sudden and exaggerated attitude changes may be necessary in order to maintain straight-and-level flight as the landing gear is extended and the flaps are lowered in some airplanes. The nose tends to pitch down with gear extension, and when flaps are lowered, lift increases momentarily (at partial flap settings) followed by a marked increase in drag as the flaps near maximum extension.

**Clean configuration:** Placing all flight control surfaces in order to create minimum drag; in most aircraft this means flaps and gear retracted.



**Figure 5-24.** *Straight-and-level flight (reduced airspeed stabilized).*

Control technique varies according to the lift and drag characteristics of each airplane. Accordingly, knowledge of the power settings and trim changes associated with different combinations of airspeed, gear and flap configurations will reduce your instrument cross-check and interpretation problems.

For example, assume that in straight-and-level flight, an airplane indicates 145 knots with power at 22" Hg manifold pressure/2,300 RPM, gear and flaps up. After reduction in airspeed, with gear and flaps fully extended, straight-and-level flight at the same altitude requires 25" Hg manifold pressure/2,500 RPM. Maximum gear extension speed is 125 knots; maximum flap extension speed is 105 knots. Airspeed reduction to 95 knots, gear and flaps down, can be made in the following manner:

1. Increase RPM to 2,500, since a high power setting will be used in full drag configuration.
2. Reduce manifold pressure to 10" Hg. As the airspeed decreases, increase cross-check speed.
3. Make trim adjustments for an increased angle of attack and decrease in torque.
4. As you lower the gear at 125 knots, the nose may tend to pitch down and the rate of deceleration increases. Increase pitch attitude to maintain constant altitude, and trim off some of the back-elevator pressures. If you lower full flaps at this point, your cross-check, interpretation, and control must be very rapid. A less difficult technique is to stabilize the airspeed and attitude with gear down before lowering the flaps.
5. Since 18" Hg manifold pressure will hold level flight at 95 knots with the gear down, increase power smoothly to that setting as the airspeed indicator shows approximately 100 knots, and retrim. The attitude indicator now shows approximately two-and-a-half bar width nose-high in straight-and-level flight.
6. Actuate the flap control and simultaneously increase power to the predetermined setting (25" Hg) for the desired airspeed, and trim off the pressures necessary to hold constant altitude and heading. The attitude indicator now shows a bar-width nose-low in straight-and-level flight at 95 knots.

You will have developed a high level of proficiency in the basic skills involved in straight-and-level flight when you can consistently maintain constant altitude and heading with smooth pitch, bank, power, and trim control during these pronounced changes in trim.

### **Trim Technique**

Proper **trim** technique is essential for smooth and precise aircraft control during all phases of flight. By relieving all control pressures, it is much easier to hold a given attitude constant, and you can devote more attention to other cockpit duties.

An aircraft is trimmed by applying control pressures to establish a desired attitude, then adjusting the trim so the aircraft will maintain that attitude when the flight controls are released. Trim the aircraft for coordinated flight by centering the ball of the turn-and-slip indicator. This is done by using rudder trim in the direction the ball is displaced from the center. Differential power control on multiengine aircraft is an additional factor affecting coordinated flight. Use balanced power or thrust, when possible, to aid in maintaining coordinated flight.

Changes in attitude, power, or configuration will require a trim adjustment, in most cases. Using trim alone to establish a change in aircraft attitude invariably leads to erratic aircraft control. Smooth and precise attitude changes are best attained by a combination of control pressures and trim adjustments. Therefore, when used correctly, trim adjustment is an aid to smooth aircraft control.

### **Common Errors in Straight-and-Level Flight**

#### *Pitch*

Pitch errors usually result from the following faults:

1. Improper adjustment of the attitude indicator's miniature aircraft to the wings-level attitude. Following your initial level-off from a climb, check the attitude indicator and make any necessary adjustment in the miniature aircraft for level flight indication at normal cruise airspeed.

2. Insufficient cross-check and interpretation of pitch instruments. For example, the airspeed indication is low. Believing you are in a nose-high attitude, you react with forward pressure without noting that a low power setting is the cause of the airspeed discrepancy. Increase your cross-check speed to include all relevant instrument indications before you make a control response.
3. **Uncaging** the attitude indicator (if it has a caging feature) when the airplane is not in level flight. The altimeter and heading indicator must be stabilized with airspeed indication at normal cruise when you pull out the caging knob, if you expect the instrument to read straight-and-level at normal cruise airspeed.
4. Failure to interpret the attitude indicator in terms of the existing airspeed.
5. Late pitch corrections. Pilots commonly like to leave well enough alone. When the altimeter shows a 20-foot error, there is a reluctance to correct it, perhaps because of fear of overcontrolling. If overcontrolling is the error, the more you practice small corrections and find out the cause of overcontrolling, the closer you will be able to hold your altitude. If you tolerate a deviation, your errors will increase.
6. Chasing the vertical-speed indications. This tendency can be corrected by proper cross-check of other pitch instruments, as well as by increasing your understanding of the instrument characteristics.
7. Using excessive pitch corrections for the altimeter evaluation. Rushing a pitch correction by making a large pitch change usually aggravates the existing error and saves neither time nor effort.
8. Failure to maintain established pitch corrections. This is a common error associated with cross-check and trim errors. For example, having established a pitch change to correct an altitude error, you tend to slow down your cross-check, waiting for the airplane to stabilize in the new pitch attitude. To maintain the attitude, you must continue to cross-check and trim off the pressures you are holding.

**Trim:** Adjusting the aerodynamic forces on the control surfaces so that the aircraft maintains the set attitude without any control input.

**Uncaging:** Unlocking the gimbals of a gyroscopic instrument, making it susceptible to damage by abrupt flight maneuvers or rough handling.

9. Fixations during cross-check. After initiating a heading correction, for example, you become preoccupied with bank control and neglect to notice a pitch error. Likewise, during an airspeed change, unnecessary gazing at the power instrument is common. Bear in mind that a small error in power setting is of less consequence than large altitude and heading errors. The airplane will not decelerate any faster if you stare at the manifold pressure gauge than if you continue your cross-check.

### *Heading*

Heading errors usually result from the following faults:

1. Failure to cross-check the heading indicator, especially during changes in power or pitch attitude.
2. Misinterpretation of changes in heading, with resulting corrections in the wrong direction.
3. Failure to note, and remember, a preselected heading.
4. Failure to observe the rate of heading change and its relation to bank attitude.
5. Overcontrolling in response to heading changes, especially during changes in power settings.
6. Anticipating heading changes with premature application of rudder control.
7. Failure to correct small heading deviations. Unless zero error in heading is your goal, you will find yourself tolerating larger and larger deviations. Correction of a 1° error takes a lot less time and concentration than correction of a 20° error.
8. Correcting with improper bank attitude. If you correct a 10° heading error with a 20° bank correction, you can roll past the desired heading before you have the bank established, requiring another correction in the opposite direction. Do not multiply existing errors with errors in corrective technique.

9. Failure to note the cause of a previous heading error and thus repeating the same error. For example, your airplane is out of trim, with a left wing low tendency. You repeatedly correct for a slight left turn, yet do nothing about trim.
10. Failure to set the heading indicator properly, or failure to uncage it.

### *Power*

Power errors usually result from the following faults:

1. Failure to know the power settings and pitch attitudes appropriate to various airspeeds and airplane configurations.
2. Abrupt use of throttle.
3. Failure to lead the airspeed when making power changes. For example, during an airspeed reduction in level flight, especially with gear and flaps extended, adjust the throttle to maintain the slower speed before the airspeed reaches the desired speed. Otherwise, the airplane will decelerate to a speed lower than that desired, resulting in further power adjustments. How much you lead the airspeed depends upon how fast the airplane responds to power changes.
4. Fixation on airspeed or manifold pressure instruments during airspeed changes, resulting in erratic control of both airspeed and power.

### *Trim*

Trim errors usually result from the following faults:

1. Improper adjustment of seat or rudder pedals for comfortable position of legs and feet. Tension in the ankles makes it difficult to relax rudder pressures.
2. Confusion as to the operation of trim devices, which differ among various airplane types. Some trim wheels are aligned appropriately with the airplane's axes; others are not. Some rotate in a direction contrary to what you expect.

3. Faulty sequence in trim technique. Trim should be used, not as a substitute for control with the wheel (stick) and rudders, but to relieve pressures already held to stabilize attitude. As you gain proficiency, you become familiar with trim settings, just as you do with power settings. With little conscious effort, you trim off pressures continually as they occur.
4. Excessive trim control. This induces control pressures that must be held until you retrim properly. Use trim frequently and in small amounts.
5. Failure to understand the cause of trim changes. If you do not understand the basic aerodynamics related to the basic instrument skills, you will continually lag behind the airplane.

## Straight Climbs and Descents

### Climbs

For a given power setting and load condition, there is only one attitude that will give the most efficient rate of climb. The airspeed and the climb power setting that will determine this climb attitude are given in the performance data found

in your POH/AFM. Details of the technique for entering a climb vary according to airspeed on entry and the type of climb (constant airspeed or constant rate) desired. (Heading and trim control are maintained as discussed under straight-and-level flight.)

### Entry

To enter a constant-airspeed climb from cruising airspeed, raise the miniature aircraft to the approximate nose-high indication for the predetermined climb speed. The attitude will vary according to the type of airplane you are flying. Apply light back-elevator pressure to initiate and maintain the climb attitude. The pressures will vary as the airplane decelerates. Power may be advanced to the climb power setting simultaneously with the pitch change, or after the pitch change is established and the airspeed approaches climb speed. If the transition from level flight to climb is smooth, the vertical speed indicator will show an immediate trend upward, continue to move slowly, then stop at a rate appropriate to the stabilized airspeed and attitude. (Primary and supporting instruments for the climb entry are shown in figure 5-25.)



Figure 5-25. Climb entry for constant-airspeed climb.



**Figure 5-26.** *Stabilized climb at constant airspeed.*

Once the airplane stabilizes at a constant airspeed and attitude, the airspeed indicator is primary for pitch and the heading indicator remains primary for bank. [Figure 5-26] You will monitor the tachometer or manifold pressure gauge as the primary power instrument to ensure the proper climb power setting is being maintained. If the climb attitude is correct for the power setting selected, the airspeed will stabilize at the desired speed. If the airspeed is low or high, make an appropriate small pitch correction.

To enter a constant-air-speed climb, first complete the airspeed reduction from cruise airspeed to climb speed in straight-and-level flight. The climb entry is then identical to entry from cruising airspeed, except that power must be increased simultaneously to the climb setting as the pitch attitude is increased. Climb entries on partial panel are more easily and accurately controlled if you enter the maneuver from climbing speed.

The technique for entering a constant-rate climb is very similar to that used for entry to a constant-air-speed climb from climb airspeed. As the power is increased to the approximate setting for the desired rate, simultaneously raise the miniature aircraft to the climbing attitude for the desired airspeed and rate of climb. As the power is increased, the airspeed indicator is primary for pitch control until the vertical speed approaches the desired value. As the vertical-speed needle stabilizes, it becomes primary for pitch control and the airspeed indicator becomes primary for power control. [Figure 5-27]

Pitch and power corrections must be promptly and closely coordinated. For example, if the vertical speed is correct, but the airspeed is low, add power. As the power is increased, the miniature aircraft must be lowered slightly to maintain constant vertical speed. If the vertical speed is high and the airspeed is low, lower the miniature aircraft slightly and note the increase in airspeed to determine whether or not a power change is also necessary. [Figure 5-28] Familiarity with the approximate power settings helps to keep your pitch and power corrections at a minimum.



Figure 5-27. Stabilized climb at constant rate.



Figure 5-28. Airspeed low and vertical speed high—reduce pitch.

### Leveling Off

To level-off from a climb and maintain an altitude, it is necessary to start the level-off before reaching the desired altitude. The amount of lead varies with rate of climb and pilot technique. If your airplane is climbing at 1,000 fpm, it will continue to climb at a decreasing rate throughout the transition to level flight. An effective practice is to lead the altitude by 10 percent of the vertical speed shown (500 fpm/50-foot lead, 1,000 fpm/100-foot lead).

To level-off at cruising airspeed, apply smooth, steady forward-elevator pressure toward level-flight attitude for the speed desired. As the attitude indicator shows the pitch change, the vertical-speed needle will move slowly toward zero, the altimeter needle will move more slowly, and the airspeed will show acceleration. [Figure 5-29] Once the altimeter, attitude indicator, and vertical speed indicator show level flight, constant changes in pitch and torque control will have to be made as the airspeed increases. As the airspeed approaches cruising speed, reduce power to the cruise setting. The amount of lead depends upon the rate of acceleration of your airplane.

To level-off at climbing airspeed, lower the nose to the pitch attitude appropriate to that airspeed in level flight. Power is simultaneously reduced to the setting for that airspeed as the pitch attitude is lowered. If your power reduction is at a rate proportionate to the pitch change, the airspeed will remain constant.

### Descents

A descent can be made at a variety of airspeeds and attitudes by reducing power, adding drag, and lowering the nose to a predetermined attitude. Sooner or later the airspeed will stabilize at a constant value. Meanwhile, the only flight instrument providing a positive attitude reference, by itself, is the attitude indicator. Without the attitude indicator (such as during a partial-panel descent) the airspeed indicator, the altimeter, and the vertical speed indicator will be showing varying rates of change until the airplane decelerates to a constant airspeed at a constant attitude. During the transition, changes in control pressure and trim, as well as cross-check and interpretation, must be very accurate if you expect to maintain positive control.



Figure 5-29. Level-off at cruising speed.



## Entry

The following method for entering descents is effective either with or without an attitude indicator. First, reduce airspeed to your selected descent airspeed while maintaining straight-and-level flight, then make a further reduction in power (to a predetermined setting). As the power is adjusted, simultaneously lower the nose to maintain constant airspeed, and trim off control pressures.

During a constant-airspeed descent, any deviation from the desired airspeed calls for a pitch adjustment. For a constant-rate descent, the entry is the same, but the vertical-speed indicator is primary for pitch control (after it stabilizes near the desired rate), and the airspeed indicator is primary for power control. Pitch and power must be closely coordinated when corrections are made, as they are in climbs. [Figure 5-30]

## Leveling Off

The level-off from a descent must be started before you reach the desired altitude. The amount of lead depends upon the rate of descent and control technique. With too little lead, you will tend to overshoot the selected altitude unless your technique is rapid. Assuming a 500-fpm rate of descent, lead the altitude by 100–150 feet for a level-off at an airspeed higher than descending speed. At the lead point, add power to the appropriate level-flight cruise setting. [Figure 5-31] Since the nose will tend to rise as the airspeed increases, hold forward-elevator pressure to maintain the vertical speed at the descending rate until approximately 50 feet above the altitude, then smoothly adjust the pitch attitude to the level-flight attitude for the airspeed selected.

To level-off from a descent at descent airspeed, lead the desired altitude by approximately 50 feet, simultaneously adjusting the pitch attitude to level flight and adding power to a setting that will hold the airspeed constant. [Figure 5-32] Trim off the control pressures and continue with the normal straight-and-level flight cross-check.



**Figure 5-30.** Constant airspeed descent, airspeed high—reduce power.



**Figure 5-31.** Level-off airspeed higher than descent airspeed.



**Figure 5-32.** Level-off at descent airspeed.

## Common Errors in Straight Climbs and Descents

Common errors result from the following faults:

1. Overcontrolling pitch on climb entry. Until you know the pitch attitudes related to specific power settings used in climbs and descents, you will tend to make larger than necessary pitch adjustments. One of the most difficult habits to acquire during instrument training is to restrain the impulse to disturb a flight attitude until you know what the result will be. Overcome your inclination to make a large control movement for a pitch change, and learn to apply small control pressures smoothly, cross-checking rapidly for the results of the change, and continuing with the pressures as your instruments show the desired results at a rate you can interpret. Small pitch changes can be easily controlled, stopped, and corrected; large changes are more difficult to control.
2. Failure to vary the rate of cross-check during speed, power, or attitude changes or climb or descent entries.
3. Failure to maintain a new pitch attitude. For example, you raise the nose to the correct climb attitude, and as the airspeed decreases, you either overcontrol and further increase the pitch attitude, or allow the nose to lower. As control pressures change with airspeed changes, cross-check must be increased and pressures readjusted.
4. Failure to trim off pressures. Unless you trim, you will have difficulty determining whether control pressure changes are induced by aerodynamic changes or by your own movements.
5. Failure to learn and use proper power settings.
6. Failure to cross-check both airspeed and vertical speed before making pitch or power adjustments.
7. Improper pitch and power coordination on slow-speed level-offs, due to slow cross-check of airspeed and altimeter indications.
8. Failure to cross-check the vertical speed indicator against the other pitch control instruments, resulting in chasing the vertical speed.
9. Failure to note the rate of climb or descent to determine the lead for level-offs, resulting in overshooting or undershooting the desired altitude.
10. Ballooning (allowing the nose to pitch up) on level-offs from descents, resulting from failure to maintain descending attitude with forward-elevator pressure as power is increased to the level flight cruise setting.
11. Failure to recognize the approaching straight-and-level flight indications as you level-off. Until you have positively established straight-and-level flight, maintain an accelerated cross-check.

## Turns

### Standard-Rate Turns

To enter a standard-rate level turn, apply coordinated aileron and rudder pressures in the desired direction of turn. Pilots commonly roll into turns at a much too rapid rate. During initial training in turns, base your control pressures on your rate of cross-check and interpretation. There is nothing to be gained by maneuvering an airplane faster than your capacity to keep up with the changes in instrument indications.

On the roll-in, use the attitude indicator to establish the approximate angle of bank, then check the turn coordinator's miniature aircraft for a standard-rate turn indication. Maintain the bank for this rate of turn, using the turn coordinator's miniature aircraft as the primary bank reference and the attitude indicator as the supporting bank instrument. [Figure 5-33] Note the exact angle of bank shown on the banking scale of the attitude indicator when the turn coordinator indicates a standard-rate turn.

During the roll-in, check the altimeter, vertical speed indicator, and attitude indicator for the necessary pitch adjustments as the vertical lift component decreases with an increase in bank. If constant airspeed is to be maintained, the airspeed indicator becomes primary for power, and the throttle must be adjusted as drag increases. As the bank is established, trim off the pressures applied during pitch and power changes.



**Figure 5-33.** Standard-rate turn, constant airspeed.

To recover to straight-and-level flight, apply coordinated aileron and rudder pressures opposite the direction of turn. If you strive for the same rate of roll-out you used to roll into the turn, you will encounter fewer problems in estimating the lead necessary for roll-out on exact headings, especially on partial-panel maneuvers. As you initiate the turn recovery, the attitude indicator becomes the primary bank instrument. When the airplane is approximately level, the heading indicator is the primary bank instrument as in straight-and-level flight. Pitch, power, and trim adjustments are made as changes in vertical lift component and airspeed occur. The ball should be checked throughout the turn, especially if control pressures are held rather than trimmed off.

Some airplanes are very stable during turns, and slight trim adjustments permit hands-off flight while the airplane remains in the established attitude. Other airplanes require constant, rapid cross-check and control during turns to correct overbanking tendencies. Due to the interrelationship of pitch, bank, and airspeed deviations during turns, your cross-check must be fast in order to prevent an accumulation of errors.

### **Turns to Predetermined Headings**

As long as an airplane is in a coordinated bank, it continues to turn. Thus, the roll-out to a desired heading must be started before the heading is reached. The amount of lead varies with the relationship between the rate of turn, angle of bank, and rate of recovery. For small heading changes, use a bank angle that does not exceed the number of degrees to be turned. Lead the desired heading by one-half the number of degrees of bank used. For example, if you maintain a  $10^\circ$  bank during a change in heading, start the roll-out  $5^\circ$  before you reach the desired heading. For larger changes in heading, the amount of lead will vary since the angle of bank for a standard-rate turn varies with the true airspeed.

Practice with a lead of one-half the angle of bank until you have determined the precise lead suitable to your technique. If your rates of roll-in and roll-out are consistent, you can readily determine the precise amount of lead suitable to your particular roll-out technique by noting the amount that you consistently undershoot or overshoot the headings.



**Figure 5-34.** Turn coordinator calibration.

### Timed Turns

A timed turn is a turn in which the clock and the turn coordinator are used to change heading a definite number of degrees in a given time. For example, in a standard-rate turn ( $3^\circ$  per second), an airplane turns  $45^\circ$  in 15 seconds; in a half-standard-rate turn, the airplane turns  $45^\circ$  in 30 seconds.

Prior to performing timed turns, the turn coordinator should be **calibrated** to determine the accuracy of its indications. [Figure 5-34] Establish a standard-rate turn as indicated by the turn coordinator, and as the sweep-second hand of the clock passes a cardinal point (12, 3, 6, 9), check the heading on the heading indicator. While holding the indicated rate of turn constant, note the indicated heading changes at 10-second intervals. If the airplane turns more or less than  $30^\circ$  in that interval, a larger or smaller deflection of the miniature aircraft of the turn coordinator is necessary to produce a standard-rate turn. When you have calibrated the turn coordinator during turns in each direction, note the corrected deflections, if any, and apply them during all timed turns.

The same cross-check and control technique is used in making timed turns that you use to execute turns to predetermined headings, except that you substitute the clock for the heading indicator. The miniature aircraft of the turn coordinator is primary for bank control, the altimeter is primary for pitch control, and the airspeed indicator is primary for power control. Start the roll-in when the clock's second hand passes a cardinal point, hold the turn at the calibrated standard rate indication (or half-standard rate for small heading changes), and begin the roll-out when the computed number of seconds has elapsed. If the rates of roll-in and roll-out are the same, the time taken during entry and recovery does not need to be considered in the time computation.

If you practice timed turns with a full instrument panel, check the heading indicator for the accuracy of your turns. If you execute the turns without the gyro heading indicator, use the magnetic compass at the completion of the turn to check turn accuracy, taking compass deviation errors into consideration.

**Calibrated:** The instrument indication was compared with a standard value to determine the accuracy of the instrument.

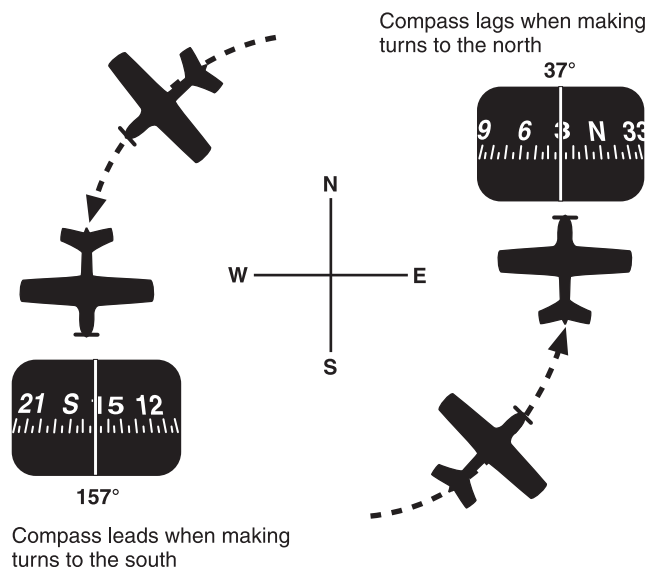
## Compass Turns

In most small airplanes, the magnetic compass is the only direction-indicating instrument independent of other airplane instruments and power sources. Because of its operating characteristics, called compass errors, pilots are prone to use it only as a reference for setting the heading indicator, but a knowledge of magnetic compass characteristics will enable you to use the instrument to turn your airplane to correct headings and maintain them.

Bear in mind the following points when making turns to magnetic compass headings or when using the magnetic compass as a reference for setting the heading indicator:

1. If you are on a northerly heading and you start a turn to the east or west, the compass indication lags, or shows a turn in the opposite direction.
2. If you are on a southerly heading and you start a turn toward the east or west, the compass indication precedes the turn, showing a greater amount of turn than is actually occurring.
3. When you are on an east or west heading, the compass indicates correctly as you start a turn in either direction.
4. If you are on an easterly or westerly heading, acceleration results in a northerly turn indication; deceleration results in a southerly turn indication.
5. If you maintain a north or south heading, no error results from diving, climbing, or changing airspeed.

With an angle of bank between  $15^\circ$  and  $18^\circ$ , the amount of lead or lag to be used when turning to northerly or southerly headings varies with, and is approximately equal to, the latitude of the locality over which the turn is being made. When turning to a heading of north, the lead for roll-out must include the number of degrees of your latitude, plus the lead you normally use in recovery from turns. During a turn to a south heading, maintain the turn until the compass passes south the number of degrees of your latitude, minus your normal roll-out lead. [Figure 5-35]



**Figure 5-35.** *Northerly and southerly turn error.*

For example, when turning from an easterly direction to north, where the latitude is  $30^\circ$ , start the roll-out when the compass reads  $37^\circ$  ( $30^\circ$  plus one-half the  $15^\circ$  angle of bank, or whatever amount is appropriate for your rate of roll-out). When turning from an easterly direction to south, start the roll-out when the magnetic compass reads  $203^\circ$  ( $180^\circ$  plus  $30^\circ$  minus one-half the angle of bank). When making similar turns from a westerly direction, the appropriate points at which to begin your roll-out would be  $323^\circ$  for a turn to north, and  $157^\circ$  for a turn to south.

When turning to a heading of east or west from a northerly direction, start the roll-out approximately  $10^\circ$  to  $12^\circ$  before the east or west indication is reached. When turning to an east or west heading from a southerly direction, start the roll-out approximately  $5^\circ$  before the east or west indication is reached. When turning to other headings, the lead or lag must be interpolated.

Abrupt changes in attitude or airspeed and the resulting erratic movements of the compass card make accurate interpretations of the instrument very difficult. Proficiency in compass turns depends on knowledge of the compass characteristics, smooth control technique, and accurate bank-and-pitch control.



**Figure 5-36.** Steep left turn.

### Steep Turns

For purposes of instrument flight training in conventional airplanes, any turn greater than a standard rate may be considered steep. [Figure 5-36] The exact angle of bank at which a normal turn becomes steep is unimportant. What is important is that you learn to control the airplane with bank attitudes in excess of those you normally use on instruments. Practice in **steep turns** will not only increase your proficiency in the basic instrument flying skills, but also enable you to react smoothly, quickly, and confidently to unexpected abnormal flight attitudes under instrument flight conditions.

Pronounced changes occur in the effects of aerodynamic forces on aircraft control at progressively steepening bank attitudes. Skill in cross-check, interpretation, and control is increasingly necessary in proportion to the amount of these

changes, though the techniques for entering, maintaining, and recovering from the turn are the same in principle for steep turns as for shallower turns.

Enter a steep turn exactly as you do a shallower turn, but prepare to cross-check rapidly as the turn steepens. Because of the greatly reduced vertical lift component, pitch control is usually the most difficult aspect of this maneuver. Unless immediately noted and corrected with a pitch increase, the loss of vertical lift results in rapid movement of the altimeter, vertical speed, and airspeed needles. The faster the rate of bank change, the more suddenly the lift changes occur. If your cross-check is fast enough to note the immediate need for pitch changes, smooth, steady back-elevator pressure will maintain constant altitude. However, if you overbank to excessively steep angles without adjusting pitch as the bank changes occur, pitch corrections require increasingly stronger

**Steep turns:** In instrument flight, anything greater than standard rate; in visual flight, anything greater than a 45° bank.

elevator pressure. The loss of vertical lift and increase in wing loading finally reach a point where further application of back-elevator pressure tightens the turn without raising the nose.

How do you recognize overbanking and a low pitch attitude? What should you do to correct it? If you observe a rapid downward movement of the altimeter needle or vertical-speed needle, together with an increase in airspeed, despite your application of back-elevator pressure, you are in a diving spiral. [Figure 5-37] Immediately shallow the bank with smooth and coordinated aileron and rudder pressures, hold or slightly relax elevator pressure, and increase your cross-check of the attitude indicator, altimeter, and vertical speed indicator. Reduce power if the airspeed increase is rapid. When the vertical speed trends upward, the altimeter needle will move slower as the vertical lift increases. When you note that the elevator is effective in raising the nose, hold the bank attitude shown on the attitude indicator and adjust elevator control pressures smoothly for the nose-high attitude appropriate to the bank maintained. If your pitch control is consistently late on your entries to steep turns, roll-out immediately to straight-and-level flight and analyze your errors. Practice shallower turns until you can keep up with

the attitude changes and control responses required, then steepen the banks as you develop quicker and more accurate control technique.

The power necessary to maintain constant airspeed increases as the bank and drag increase. With practice, you quickly learn the power settings appropriate to specific bank attitudes, and can make adjustments without undue attention to airspeed and power instruments. During training in steep turns, as in any other maneuver, attend to first things first. If you keep the pitch attitude relatively constant, you have more time to cross-check, interpret, and control for accurate airspeed and bank control.

During recovery from steep turns to straight-and-level flight, elevator and power control must be coordinated with bank control in proportion to the changes in aerodynamic forces. Back-elevator pressures must be released and power decreased. The common errors associated with steep turns are the same as those discussed later in this section; however, remember, errors are more exaggerated, more difficult to correct, and more difficult to analyze unless your rates of entry and recovery are consistent with your level of proficiency in the three basic instrument flying skills.



**Figure 5-37.** Diving spiral.



### Climbing and Descending Turns

To execute climbing and descending turns, combine the technique used in straight climbs and descents with the various turn techniques. The aerodynamic factors affecting lift and power control must be considered in determining power settings, and the rate of cross-check and interpretation must be increased to enable you to control bank as well as pitch changes.

### Change of Airspeed in Turns

Changing airspeed in turns is an effective maneuver for increasing your proficiency in all three basic instrument skills. Since the maneuver involves simultaneous changes in all components of control, proper execution requires rapid cross-check and interpretation as well as smooth control. Proficiency in the maneuver will also contribute to your confidence in the instruments during attitude and power changes involved in more complex maneuvers. Pitch and power control techniques are the same as those used during changes in airspeed in straight-and-level flight.

The angle of bank necessary for a given rate of turn is proportional to the true airspeed. Since the turns are executed at a standard rate, the angle of bank must be varied in direct proportion to the airspeed change in order to maintain a constant rate of turn. During a reduction of airspeed, you must decrease the angle of bank and increase the pitch attitude to maintain altitude and a standard-rate turn.

The altimeter and turn coordinator indications should remain constant throughout the turn. The altimeter is primary for pitch control and the miniature aircraft of the turn coordinator is primary for bank control. The manifold pressure gauge (or tachometer) is primary for power control while the airspeed is changing. As the airspeed approaches the new indication, the airspeed indicator becomes primary for power control.

Two methods of changing airspeed in turns may be used. In the first method, airspeed is changed after the turn is established [Figure 5-38]; in the second method, the airspeed change is initiated simultaneously with the turn entry. The first method is easier, but regardless of the method used, the rate of cross-check must be increased as you reduce power. As the airplane decelerates, check the altimeter and vertical speed indicator for needed pitch changes and the bank instruments for needed bank changes. If the miniature aircraft of the turn coordinator shows a deviation from the desired deflection, change the bank. Adjust pitch attitude to maintain altitude. When approaching the desired airspeed, it becomes primary for power control and the manifold pressure gauge (or tachometer) is adjusted to maintain the desired airspeed. Trim is important throughout the maneuver to relieve control pressures.



Figure 5-38. Change of airspeed in turn.

Until your control technique is very smooth, frequent cross-check of the attitude indicator is essential to keep from overcontrolling and to provide approximate bank angles appropriate to the changing airspeeds.

### **Common Errors in Turns**

#### *Pitch*

Pitch errors result from the following faults:

1. Preoccupation with bank control during turn entry and recovery. If it takes 5 seconds to roll into a turn, check the pitch instruments as you initiate bank pressures. If your bank control pressure and rate of bank change are consistent, you will soon develop a sense of timing that tells you how long an attitude change will take. During the interval, you check pitch, power, and trim—as well as bank—controlling the total attitude instead of one factor at a time.
2. Failure to understand or remember the need for changing the pitch attitude as the vertical lift component changes, resulting in consistent loss of altitude during entries.
3. Changing the pitch attitude before it is necessary. This fault is very likely if your cross-check is slow and your rate of entry too rapid. The error occurs during the turn entry due to a mechanical and premature application of back-elevator control pressure.
4. Overcontrolling the pitch changes. This fault commonly occurs with the previous error.
5. Failure to properly adjust the pitch attitude as the vertical lift component increases during the roll-out, resulting in consistent gain in altitude on recovery to headings.
6. Failure to trim during turn entry and following turn recovery (if turn is prolonged).
7. Failure to maintain straight-and-level cross-check after roll-out. This error commonly follows a perfectly executed turn.
8. Erratic rates of bank change on entry and recovery, resulting from failure to cross-check the pitch instruments with a consistent technique appropriate to the changes in lift.

#### *Bank*

Bank and heading errors result from the following faults:

1. Overcontrolling, resulting in overbanking upon turn entry, overshooting and undershooting headings, as well as aggravated pitch, airspeed, and trim errors.
2. Fixation on a single bank instrument. On a 90° change of heading, for example, leave the heading indicator out of your cross-check for approximately 20 seconds after establishing a standard-rate turn, since at 3° per second you will not approach the lead point until that time has elapsed. Make your cross-check selective; check what needs to be checked at the appropriate time.
3. Failure to check for precession of the horizon bar following recovery from a turn. If the heading indicator shows a change in heading when the attitude indicator shows level flight, the airplane is turning. If the ball is centered, the attitude gyro has precessed; if the ball is not centered, the airplane may be in a slipping or skidding turn. Center the ball with rudder pressure, check the attitude indicator and heading indicator, stop the heading change if it continues, and retrim.
4. Failure to use the proper degree of bank for the amount of heading change desired. Rolling into a 20° bank for a heading change of 10° will normally overshoot the heading. Use the bank attitude appropriate to the amount of heading change desired.
5. Failure to remember the heading you are turning to. This fault is likely when you rush the maneuver.
6. Turning in the wrong direction, due either to misreading or misinterpreting the heading indicator, or to confusion as to the location of points on the compass. Turn in the shortest direction to reach a given heading, unless you

have a specific reason to turn the long way around. Study the compass rose until you can visualize at least the positions of the eight major points around the azimuth. A number of methods can be used to make quick computations for heading changes. For example, to turn from a heading of 305° to a heading of 110°, do you turn right or left for the shortest way around? Subtracting 200 from 305 and adding 20, you get 125° as the reciprocal of 305°; therefore, execute the turn to the right. Likewise, to figure the reciprocal of a heading less than 180°, add 200 and subtract 20. If you can compute more quickly using multiples of 100s and 10s than by adding or subtracting 180° from the actual heading, the method suggested above may save you time and confusion.

7. Failure to check the ball of the turn coordinator when interpreting the instrument for bank information. If the roll rate is reduced to zero, the miniature aircraft of the turn coordinator indicates only direction and rate of turn. Unless the ball is centered, you cannot assume the turn is resulting from a banked attitude.

### *Power*

Power and airspeed errors result from the following faults:

1. Failure to cross-check the airspeed indicator as you make pitch changes.
2. Erratic use of power control. This may be due to improper throttle friction control, inaccurate throttle settings, chasing the airspeed readings, abrupt or overcontrolled pitch-and-bank changes, or failure to recheck the airspeed to note the effect of a power adjustment.
3. Poor coordination of throttle control with pitch-and-bank changes, associated with slow cross-check or failure to understand the aerodynamic factors related to turns.

### *Trim*

Trim errors result from the following faults:

1. Failure to recognize the need for a trim change may be due to slow cross-check and interpretation. For example, a turn entry at a rate too rapid for your cross-check leads to confusion in cross-check and interpretation, with resulting tension on the controls.

2. Failure to understand the relationship between trim and attitude/power changes.
3. Chasing the vertical-speed needle. Overcontrolling leads to tension and prevents you from sensing the pressures to be trimmed off.
4. Failure to trim following power changes.

### *Errors During Compass Turns*

In addition to the faults discussed above, the following errors connected with compass turns should be noted:

1. Faulty understanding or computation of lead and lag.
2. Fixation on the compass during the roll-out. Until the airplane is in straight-and-level, unaccelerated flight, there is no point in reading the indicated heading. Accordingly, after you initiate the roll-out, cross-check for straight-and-level flight before checking the accuracy of your turn.

### **Approach to Stall**

Practicing approach to stall recoveries in various airplane configurations should build confidence in your ability to control the airplane in unexpected situations. Approach to stall should be practiced from straight flight and from shallow banks. The objective is to practice recognition and recovery from the approach to a stall.

Prior to stall recovery practice, select a safe altitude above the terrain, an area free of conflicting air traffic, adequate weather, and the use of radar traffic advisory service should be among the items considered.

Approach to stalls are accomplished in the following configurations:

1. Takeoff configuration—should begin from level flight near liftoff speed. Power should be applied while simultaneously increasing the angle of attack to induce an indication of a stall.
2. Clean configuration—should begin from a reduced airspeed, such as pattern airspeed, in level flight. Power should be applied while simultaneously increasing the angle of attack to induce an indication of a stall.

3. Approach or landing configuration—should be initiated at the appropriate approach or landing airspeed. The angle of attack should be smoothly increased to induce an indication of a stall.

Recoveries should be prompt in response to a stall warning device or an aerodynamic indication, by smoothly reducing the angle of attack and applying maximum power, or as recommended by the POH/AFM. The recovery should be completed without an excessive loss of altitude, and on a predetermined heading, altitude, and airspeed.

### Unusual Attitudes and Recoveries

An unusual attitude is an airplane attitude not normally required for instrument flight. Unusual attitudes may result from a number of conditions, such as turbulence, disorientation, instrument failure, confusion, preoccupation with cockpit duties, carelessness in cross-checking, errors in instrument interpretation, or lack of proficiency in aircraft control. Since unusual attitudes are not intentional maneuvers during instrument flight, except in training, they are often unexpected, and the reaction of an inexperienced or inadequately trained pilot to an unexpected abnormal flight attitude is usually instinctive rather than intelligent and deliberate. This individual reacts with abrupt muscular effort,

which is purposeless and even hazardous in turbulent conditions, at excessive speeds, or at low altitudes. However, with practice, the techniques for rapid and safe recovery from unusual attitudes can be learned.

When an unusual attitude is noted on your cross-check, the immediate problem is not how the airplane got there, but what it is doing and how to get it back to straight-and-level flight as quickly as possible.

### Recognizing Unusual Attitudes

As a general rule, any time you note an instrument rate of movement or indication other than those you associate with the basic instrument flight maneuvers already learned, assume an unusual attitude and increase the speed of cross-check to confirm the attitude, instrument error, or instrument malfunction.

Nose-high attitudes are shown by the rate and direction of movement of the altimeter needle, vertical-speed needle, and airspeed needle, as well as the immediately recognizable indication of the attitude indicator (except in extreme attitudes). [Figure 5-39] Nose-low attitudes are shown by the same instruments, but in the opposite direction. [Figure 5-40]



Figure 5-39. Unusual attitude—nose high.



**Figure 5-40.** Unusual attitude—nose-low.

### Recovery From Unusual Attitudes

In moderate unusual attitudes, the pilot can normally reorient him/herself by establishing a level flight indication on the attitude indicator. However, the pilot should not depend on this instrument for the following reasons: If the attitude indicator is the spillable type, its upset limits may have been exceeded; it may have become inoperative due to mechanical malfunction; even if it is the nonspillable-type instrument and is operating properly, errors up to 5° of pitch-and-bank may result and its indications are very difficult to interpret in extreme attitudes. As soon as the unusual attitude is detected, the recommended recovery procedures stated in the POH/AFM should be initiated. If there are no recommended procedures stated in the POH/AFM, the recovery should be initiated by reference to the airspeed indicator, altimeter, vertical speed indicator, and turn coordinator.

### Nose-High Attitudes

If the airspeed is decreasing, or below the desired airspeed, increase power (as necessary in proportion to the observed deceleration), apply forward-elevator pressure to lower the nose and prevent a stall, and correct the bank by applying coordinated aileron and rudder pressure to level the miniature aircraft and center the ball of the turn coordinator. The corrective control applications are made almost simultaneously, but in the sequence given above. A level pitch attitude is indicated by the reversal and stabilization of the airspeed indicator and altimeter needles. Straight coordinated flight is indicated by the level miniature aircraft and centered ball of the turn coordinator.

### Nose-Low Attitudes

If the airspeed is increasing, or is above the desired airspeed, reduce power to prevent excessive airspeed and loss of altitude. Correct the bank attitude with coordinated aileron and rudder pressure to straight flight by referring to the turn

coordinator. Raise the nose to level flight attitude by applying smooth back-elevator pressure. All components of control should be changed simultaneously for a smooth, proficient recovery. However, during initial training a positive, confident recovery should be made by the numbers, in the sequence given above. A very important point to remember is that the instinctive reaction to a nose-down attitude is to pull back on the elevator control.

After initial control has been applied, continue with a fast cross-check for possible overcontrolling, since the necessary initial control pressures may be large. As the rate of movement of altimeter and airspeed indicator needles decreases, the attitude is approaching level flight. When the needles stop and reverse direction, the aircraft is passing through level flight. As the indications of the airspeed indicator, altimeter, and turn coordinator stabilize, incorporate the attitude indicator into the cross-check.

The attitude indicator and turn coordinator should be checked to determine bank attitude, and then corrective aileron and rudder pressures should be applied. The ball should be centered. If it is not, skidding and slipping sensations can easily aggravate disorientation and retard recovery. If you enter the unusual attitude from an assigned altitude (either by your instructor or by air traffic control (ATC) if operating under instrument flight rules (IFR)), return to the original altitude after stabilizing in straight-and-level flight.

### **Common Errors in Unusual Attitudes**

Common errors associated with unusual attitudes include the following faults:

1. Failure to keep the airplane properly trimmed. A cockpit interruption when you are holding pressures can easily lead to inadvertent entry into unusual attitudes.
2. Disorganized cockpit. Hunting for charts, logs, computers, etc., can seriously detract your attention from the instruments.
3. Slow cross-check and fixations. Your impulse is to stop and stare when you note an instrument discrepancy unless you have trained enough to develop the skill required for immediate recognition.

4. Attempting to recover by sensory sensations other than sight. The discussion of disorientation in Chapter 1 (“Human Factors”) indicates the importance of trusting your instruments.
5. Failure to practice basic instrument skills once you have learned them. All of the errors noted in connection with basic instrument skills are aggravated during unusual attitude recoveries until the elementary skills have been mastered.

## **Instrument Takeoff**

Your competency in **instrument takeoffs** will provide the proficiency and confidence necessary for use of flight instruments during departures under conditions of low visibility, rain, low ceilings, or disorientation at night. A sudden rapid transition from “visual” to “instrument” flight can result in serious disorientation and control problems.

Instrument takeoff techniques vary with different types of airplanes, but the method described below is applicable whether the airplane is single- or multiengine; tricycle-gear or conventional-gear.

Align the airplane with the centerline of the runway with the nosewheel or tailwheel straight. (Your instructor pilot may align the airplane if he/she has been taxiing while you perform the instrument check under a hood or visor.) Lock the tailwheel, if so equipped, and hold the brakes firmly to avoid creeping while you prepare for takeoff. Set the heading indicator with the nose index on the 5° mark nearest the published runway heading, so you can instantly detect slight changes in heading during the takeoff. Make certain that the instrument is uncaged (if it has a caging feature) by rotating the knob after uncaging and checking for constant heading indication. If you use an electric heading indicator with a rotatable needle, rotate the needle so that it points to the nose position, under the top index. Advance the throttle to an RPM that will provide partial rudder control. Release the brakes, advancing the power smoothly to takeoff setting.

During the takeoff roll, hold the heading constant on the heading indicator by using the rudder. In multiengine, propeller-driven airplanes, also use differential throttle to maintain direction. The use of brakes should be avoided,

**Instrument takeoff:** Using the instruments rather than outside visual cues to maintain runway heading and execute a safe takeoff.

except as a last resort, as it usually results in overcontrolling and extending the takeoff roll. Once you release the brakes, any deviation in heading must be corrected instantly.

As the airplane accelerates, cross-check both heading indicator and airspeed indicator rapidly. The attitude indicator may precess to a slight nose-up attitude. As flying speed is approached (approximately 15-25 knots below takeoff speed), smoothly apply elevator control for the desired takeoff attitude on the attitude indicator. This is approximately a 2-bar-width climb indication for most small airplanes.

Continue with a rapid cross-check of heading indicator and attitude indicator as the airplane leaves the ground. Do not pull it off; let it fly off while you hold the selected attitude constant. Maintain pitch-and-bank control by referencing the attitude indicator, and make coordinated corrections in heading when indicated on the heading indicator. Cross-check the altimeter and vertical speed indicator for a positive rate of climb (steady clockwise rotation of the altimeter needle at a rate that you can interpret with experience, and the vertical speed indicator showing a stable rate of climb appropriate to the airplane).

When the altimeter shows a safe altitude (approximately 100 feet), raise the landing gear and flaps, maintaining attitude by referencing the attitude indicator. Because of control pressure changes during gear and flap operation, overcontrolling is likely unless you note pitch indications accurately and quickly. Trim off control pressures necessary to hold the stable climb attitude. Check the altimeter, vertical speed indicator, and airspeed for a smooth acceleration to the predetermined climb speed (altimeter and airspeed increasing, vertical speed stable). At climb speed, reduce power to climb setting (unless full power is recommended for climb by your POH/AFM and trim).

Throughout the instrument takeoff, cross-check and interpretation must be rapid, and control positive and smooth. During liftoff, gear and flap retraction, and power reduction, the changing control reactions demand rapid cross-check, adjustment of control pressures, and accurate trim changes.

### **Common Errors in Instrument Takeoffs**

Common errors during the instrument takeoff include the following:

1. Failure to perform an adequate cockpit check before the takeoff. Pilots have attempted instrument takeoffs with inoperative airspeed indicators (pitot tube obstructed), gyros caged, controls locked, and numerous other oversights due to haste or carelessness.
2. Improper alignment on the runway. This may result from improper brake application, allowing the airplane to creep after alignment, or from alignment with the nosewheel or tailwheel cocked. In any case, the result is a built-in directional control problem as the takeoff starts.
3. Improper application of power. Abrupt application of power complicates directional control. Add power with a smooth, uninterrupted motion.
4. Improper use of brakes. Incorrect seat or rudder pedal adjustment, with your feet in an uncomfortable position, frequently causes inadvertent application of brakes and excessive heading changes.
5. Overcontrolling rudder pedals. This fault may be caused by late recognition of heading changes, tension on the controls, misinterpretation of the heading indicator (and correcting in the wrong direction), failure to appreciate changing effectiveness of rudder control as the aircraft accelerates, and other factors. If heading changes are observed and corrected instantly with small movement of the rudder pedals, swerving tendencies can be reduced.
6. Failure to maintain attitude after becoming airborne. If you react to seat-of-the-pants sensations when the airplane lifts off, your pitch control is guesswork. You may either allow excessive pitch or apply excessive forward-elevator pressure, depending on your reaction to trim changes.
7. Inadequate cross-check. Fixations are likely during trim changes, attitude changes, gear and flap retractions, and power changes. Once you check an instrument or apply a control, continue the cross-check and note the effect of your control during the next cross-check sequence.
8. Inadequate interpretation of instruments. Failure to understand instrument indications immediately indicates that further study of the maneuver is necessary.

## Basic Instrument Flight Patterns

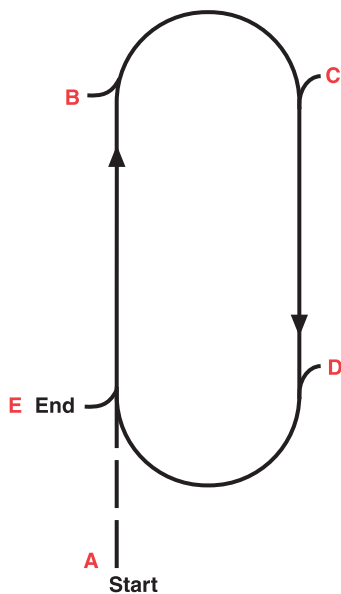
After you have attained a reasonable degree of proficiency in basic maneuvers, you can apply your skills to the various combinations of individual maneuvers. The following practice **flight patterns** are directly applicable to operational instrument flying.

### Racetrack Pattern

Steps:

1. Time 3 minutes straight-and-level flight from A to B. [Figure 5-41] During this interval, reduce airspeed to the holding speed appropriate for your aircraft.
2. Start 180° standard-rate turn at B. Roll-out at C on the reciprocal of your heading at A.
3. Time 1 minute straight-and-level flight from C to D.
4. Start 180° standard rate level turn at D, rolling-out on original heading.

*Note:* This pattern is an exercise combining use of the clock with basic maneuvers.



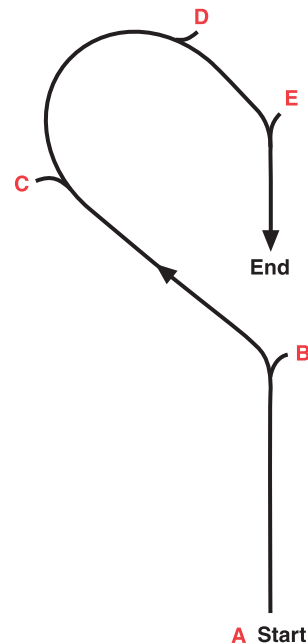
**Figure 5-41.** Racetrack pattern (entire pattern in level flight).

**Flight patterns:** Basic maneuvers, flown by sole reference to the instruments rather than outside visual cues, for the purpose of practicing basic attitude flying. The patterns simulate maneuvers encountered on instrument flights such as holding patterns, procedure turns, and approaches.

### Standard Procedure Turn

Steps:

1. Start timing at A for 2 minutes from A to B. [Figure 5-42]
2. At B, turn 45° (standard rate). After roll-out, fly 1 minute to C.
3. At C, turn 180°.
4. At completion of turn, time 45 seconds from D to E.
5. Start turn at E for 45° change of heading to reciprocal of heading at beginning of maneuver.



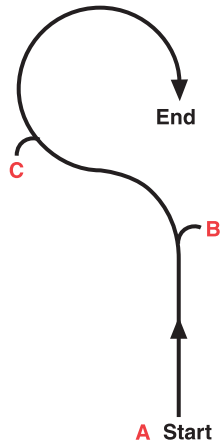
**Figure 5-42.** Standard procedure turn (entire pattern in level flight).

### 80/260 Procedure Turn

Steps:

1. Start timing at A for 2 minutes from A to B. [Figure 5-43]
2. At B, enter a left standard-rate turn for a heading change of 80°.
3. At the completion of the 80° turn at C, immediately turn right for a heading change of 260°, rolling-out on the reciprocal of the entry heading.



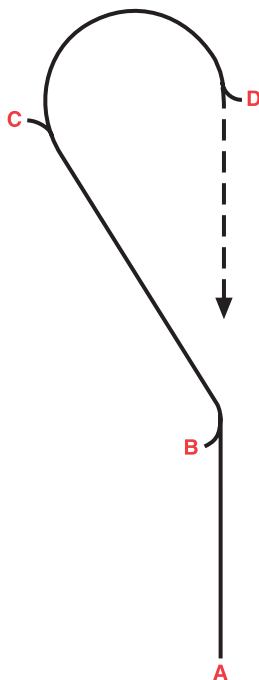


**Figure 5-43.** 80/260 procedure turn (entire pattern in level flight).

### Teardrop Pattern

Steps:

1. Start timing at A for 2 minutes from A to B. [Figure 5-44] Reduce airspeed to holding speed in this interval.
2. At B, enter standard-rate turn for 30° change of heading. Time 1 minute from B to C.
3. At C, enter standard-rate turn for a 210° change of heading, rolling-out on the reciprocal of the original entry heading.



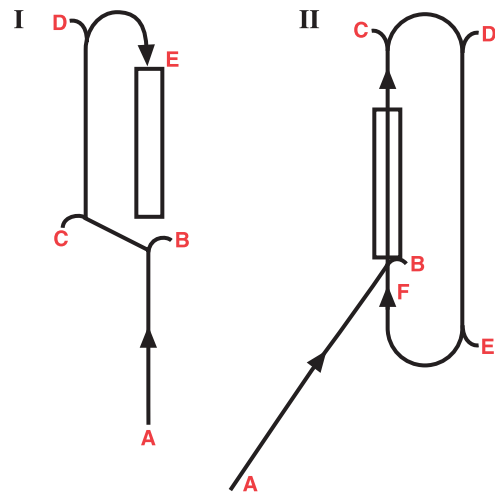
**Figure 5-44.** Teardrop pattern (entire pattern in level flight).

### Circling Approaches Pattern

#### Pattern I

Steps:

1. At A, start timing for 2 minutes from A to B; reduce airspeed to approach speed. [Figure 5-45, I]
2. At B, make a standard-rate turn to the left for 45°.
3. At the completion of the turn, time for 45 seconds to C.
4. At C, turn to the original heading; fly 1 minute to D, lowering the landing gear and flaps.
5. At D, turn right 180°, rolling-out at E on the reciprocal of the entry heading.
6. At E, enter a 500 fpm rate descent. At the end of a 500-foot descent, enter a straight constant-airspeed climb, retracting gear and flaps.



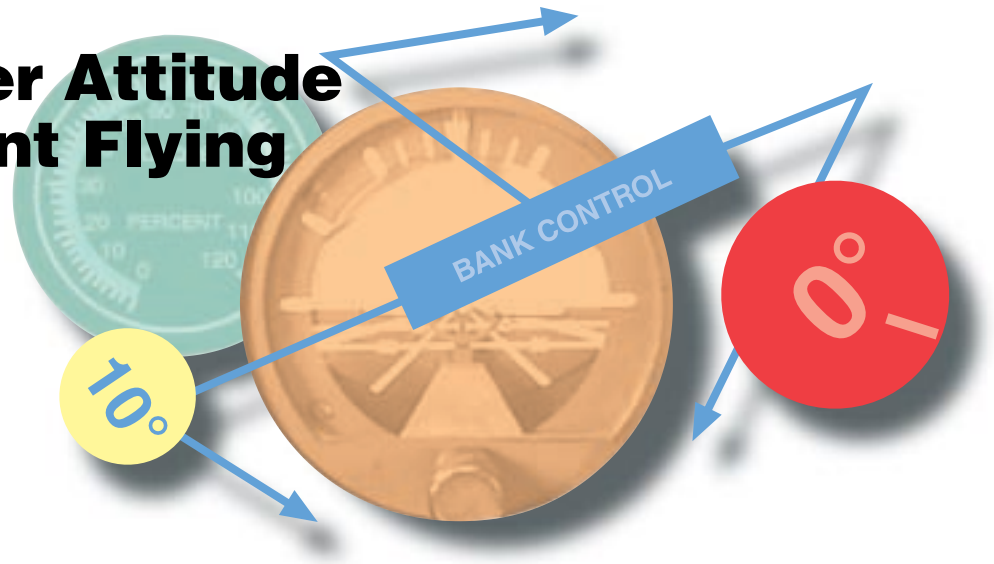
**Figure 5-45.** Patterns applicable to circling approaches (runways are imaginary).

#### Pattern II

Steps:

1. At A, start timing for 2 minutes from A to B; reduce airspeed to approach speed. [Figure 5-45, II]
2. At B, make a standard-rate turn to the left for 45°.
3. At the completion of the turn, time for 1 minute to C.
4. At C, turn right for 180°; fly for 1-1/2 minutes to E, lowering the landing gear and flaps.
5. At E, turn right for 180°, rolling-out at F.
6. At F, enter a 500 fpm rate descent. At the end of a 500-foot descent, enter a straight constant-airspeed climb, retracting gear and flaps.

# Helicopter Attitude Instrument Flying



## Introduction

**Attitude instrument flying** in helicopters is essentially visual flying with the flight instruments substituted for the various reference points on the helicopter and the natural horizon. Control changes, required to produce a given attitude by reference to instruments, are identical to those used in helicopter visual flight rules (VFR) flight, and your thought processes are the same. Basic instrument training is intended as a building block towards attaining an instrument rating.

## Flight Instruments

When flying a helicopter with reference to the flight instruments, proper instrument interpretation is the basis for aircraft control. Your skill, in part, depends on your understanding of how a particular instrument or system functions, including its indications and limitations (*see* Chapter 3, “Flight Instruments”). With this knowledge, you can quickly determine what an instrument is telling you and translate that information into a control response.

## Instrument Flight

To achieve smooth, positive control of the helicopter during instrument flight, you need to develop three fundamental skills. They are instrument cross-check, instrument interpretation, and aircraft control.

### **Attitude instrument flying:**

Controlling the aircraft by reference to the instruments rather than outside visual cues.

## Instrument Cross-Check

Cross-checking, sometimes referred to as scanning, is the continuous and logical observation of instruments for attitude and performance information. In attitude instrument flying, an attitude is maintained by reference to the instruments, which produces the desired result in performance. Due to human error, instrument error, and helicopter performance differences in various atmospheric and loading conditions, it is difficult to establish an attitude and have performance remain constant for a long period of time. These variables make it necessary for you to constantly check the instruments and make appropriate changes in the helicopter’s attitude. The actual technique may vary depending on what instruments are installed and where they are installed, as well as your experience and proficiency level. This discussion concentrates on the six basic flight instruments. [Figure 6-1]

At first, you may have a tendency to cross-check rapidly, looking directly at the instruments without knowing exactly what information you are seeking. However, with familiarity and practice, the instrument cross-check reveals definite trends during specific flight conditions. These trends help you control the helicopter as it makes a transition from one flight condition to another.



**Figure 6-1.** In most situations, the cross-check pattern includes the attitude indicator between the cross-check of each of the other instruments. A typical cross-check might progress as follows: attitude indicator, altimeter, attitude indicator, vertical speed indicator, attitude indicator, heading indicator, attitude indicator, and so on.

If you apply your full concentration to a single instrument, you will encounter a problem called **fixation**. This results from a natural human inclination to observe a specific instrument carefully and accurately, often to the exclusion of other instruments. Fixation on a single instrument usually results in poor control. For example, while performing a turn, you may have a tendency to watch only the turn-and-slip indicator instead of including other instruments in your cross-check. This fixation on the turn-and-slip indicator often leads to a loss of altitude through poor pitch-and-bank control. You should look at each instrument only long enough to understand the information it presents, then continue on to the next one. Similarly, you may find yourself placing too much “emphasis” on a single instrument, instead of relying on a combination of instruments necessary for helicopter perfor-

mance information. This differs from fixation in that you are using other instruments, but are giving too much attention to a particular one.

During performance of a maneuver, you may sometimes fail to anticipate significant instrument indications following attitude changes. For example, during level-off from a climb or descent, you may concentrate on pitch control, while forgetting about heading or roll information. This error, called “omission,” results in erratic control of heading and bank.

In spite of these common errors, most pilots can adapt well to flight by instrument reference after instruction and practice. You may find that you can control the helicopter more easily and precisely by instruments.

**Fixation:** Staring at a single instrument, thereby interrupting the cross-check process.

## Instrument Interpretation

The flight instruments together give a picture of what is going on. No one instrument is more important than the next; however, during certain maneuvers or conditions, those instruments that provide the most pertinent and useful information are termed primary instruments. Those which back up and supplement the primary instruments are termed supporting instruments. For example, since the attitude indicator is the only instrument that provides instant and direct aircraft attitude information, it should be considered primary during any change in pitch or bank attitude. After the new attitude is established, other instruments become primary, and the attitude indicator usually becomes the supporting instrument.

## Aircraft Control

Controlling the helicopter is the result of accurately interpreting the flight instruments and translating these readings into correct control responses. Aircraft control involves adjustment to pitch, bank, power, and trim in order to achieve a desired flight path.

Pitch attitude control is controlling the movement of the helicopter about its lateral axis. After interpreting the helicopter's pitch attitude by reference to the pitch instruments (attitude indicator, altimeter, airspeed indicator, and vertical speed indicator), cyclic control adjustments are made to affect the desired pitch attitude. In this chapter, the pitch attitudes depicted are approximate and will vary with different helicopters.

Bank attitude control is controlling the angle made by the lateral tilt of the rotor and the natural horizon, or, the movement of the helicopter about its longitudinal axis. After interpreting the helicopter's bank instruments (attitude indicator, heading indicator, and turn indicator), cyclic control adjustments are made to attain the desired bank attitude.

Power control is the application of collective pitch with corresponding throttle control, where applicable. In straight-and-level flight, changes of collective pitch are made to correct for altitude deviations if the error is more than 100 feet, or the airspeed is off by more than 10 knots. If the error is less than that amount, use a slight cyclic climb or descent.

In order to fly a helicopter by reference to the instruments, you should know the approximate power settings required for your particular helicopter in various load configurations and flight conditions.

Trim, in helicopters, refers to the use of the cyclic centering button, if the helicopter is so equipped, to relieve all possible cyclic pressures. Trim also refers to the use of pedal adjustment to center the ball of the turn indicator. Pedal trim is required during all power changes.

The proper adjustment of collective pitch and cyclic friction helps you relax during instrument flight. Friction should be adjusted to minimize **overcontrolling** and to prevent creeping, but not applied to such a degree that control movement is limited. In addition, many helicopters equipped for instrument flight contain stability augmentation systems or an autopilot to help relieve pilot workload.

## Straight-and-Level Flight

Straight-and-level unaccelerated flight consists of maintaining the desired altitude, heading, airspeed, and pedal trim.

### Pitch Control

The pitch attitude of a helicopter is the angular relation of its longitudinal axis and the natural horizon. If available, the attitude indicator is used to establish the desired pitch attitude. In level flight, pitch attitude varies with airspeed and center of gravity. At a constant altitude and a stabilized airspeed, the pitch attitude is approximately level. [Figure 6-2]

### Attitude Indicator

The attitude indicator gives a **direct indication** of the pitch attitude of the helicopter. In visual flight, you attain the desired pitch attitude by using the cyclic to raise and lower the nose of the helicopter in relation to the natural horizon. During instrument flight, you follow exactly the same procedure in raising or lowering the miniature aircraft in relation to the horizon bar.

You may note some delay between control application and resultant instrument change. This is the normal control lag in the helicopter and should not be confused with instrument lag. The attitude indicator may show small misrepresentations of pitch attitude during maneuvers involving acceleration,

**Overcontrolling:** Using more movement in the cyclic or collective than necessary to achieve the desired pitch-and-bank condition.

**Direct indication:** The true and instantaneous reflection of aircraft pitch-and-bank attitude by the miniature aircraft, relative to the horizon bar of the attitude indicator.



**Figure 6-2.** The flight instruments for pitch control are the airspeed indicator, attitude indicator, altimeter, and vertical speed indicator.

deceleration, or turns. This precession error can be detected quickly by cross-checking the other pitch instruments.

If the miniature aircraft is properly adjusted on the ground, it may not require readjustment in flight. If the miniature aircraft is not on the horizon bar after level-off at normal cruising airspeed, adjust it as necessary while maintaining level flight with the other pitch instruments. Once the miniature aircraft has been adjusted in level flight at normal cruising airspeed, leave it unchanged so it will give an accurate picture of pitch attitude at all times.

When making initial pitch attitude corrections to maintain altitude, the changes of attitude should be small and smoothly applied. The initial movement of the horizon bar should not exceed one bar width high or low. [Figure 6-3] If a further change is required, an additional correction of one-half bar normally corrects any deviation from the desired altitude. This one-and-one-half bar correction is normally the maximum pitch attitude correction from level flight attitude. After you have made the correction, cross-check the other pitch instruments to determine whether the pitch attitude



**Figure 6-3.** The initial pitch correction at normal cruise is one bar width.

change is sufficient. If more correction is needed to return to altitude, or if the airspeed varies more than 10 knots from that desired, adjust the power.

### *Altimeter*

The altimeter gives an **indirect indication** of the pitch attitude of the helicopter in straight-and-level flight. Since the altitude should remain constant in level flight, deviation from the desired altitude shows a need for a change in pitch attitude, and if necessary, power. When losing altitude, raise the pitch attitude and, if necessary, add power. When gaining altitude, lower the pitch attitude and, if necessary, reduce power.

The rate at which the altimeter moves helps in determining pitch attitude. A very slow movement of the altimeter indicates a small deviation from the desired pitch attitude, while a fast movement of the altimeter indicates a large deviation from the desired pitch attitude. Make any corrective action promptly, with small control changes. Also, remember that movement of the altimeter should always be corrected by two distinct changes. The first is a change of attitude to stop the altimeter; and the second, a change of attitude to return smoothly to the desired altitude. If the altitude and airspeed are more than 100 feet and 10 knots low, respectively, apply power along with an increase of pitch attitude. If the altitude and airspeed are high by more than 100 feet and 10 knots, reduce power and lower the pitch attitude.

There is a small lag in the movement of the altimeter; however, for all practical purposes, consider that the altimeter gives an immediate indication of a change, or a need for change in pitch attitude.

Since the altimeter provides the most pertinent information regarding pitch in level flight, it is considered primary for pitch.

### *Vertical Speed Indicator*

The vertical speed indicator (VSI) gives an indirect indication of the pitch attitude of the helicopter and should be used in conjunction with the other pitch instruments to attain a high

degree of accuracy and precision. The instrument indicates zero when in level flight. Any movement of the needle from the zero position shows a need for an immediate change in pitch attitude to return it to zero. Always use the vertical speed indicator in conjunction with the altimeter in level flight. If a movement of the vertical speed indicator is detected, immediately use the proper corrective measures to return it to zero. If the correction is made promptly, there is usually little or no change in altitude. If you do not zero the needle of the vertical speed indicator immediately, the results will show on the altimeter as a gain or loss of altitude.

The initial movement of the vertical speed needle is instantaneous and indicates the trend of the vertical movement of the helicopter. A period of time is necessary for the vertical speed indicator to reach its maximum point of deflection after a correction has been made. This time element is commonly referred to as **lag**. The lag is directly proportional to the speed and magnitude of the pitch change. If you employ smooth control techniques and make small adjustments in pitch attitude, lag is minimized, and the vertical speed indicator is easy to interpret. Overcontrolling can be minimized by first neutralizing the controls and allowing the pitch attitude to stabilize; then readjusting the pitch attitude by noting the indications of the other pitch instruments.

Occasionally, the vertical speed indicator may be slightly out of calibration. This could result in the instrument indicating a slight climb or descent even when the helicopter is in level flight. If it cannot be readjusted properly, this error must be taken into consideration when using the vertical speed indicator for pitch control. For example, if the vertical speed indicator showed a descent of 100 feet per minute (fpm) when the helicopter was in level flight, you would have to use that indication as level flight. Any deviation from that reading would indicate a change in attitude.

### *Airspeed Indicator*

The airspeed indicator gives an indirect indication of helicopter pitch attitude. With a given power setting and pitch attitude, the airspeed remains constant. If the airspeed increases, the nose is too low and should be raised. If the airspeed decreases, the nose is too high and should be

## **Instrument flight fundamental:**

**Attitude + Power = Performance**

**Indirect indication:** A reflection of aircraft pitch-and-bank attitude by the instruments other than the attitude indicator.

**Lag:** The delay that occurs before an instrument needle attains a stable indication.

lowered. A rapid change in airspeed indicates a large change in pitch attitude, and a slow change in airspeed indicates a small change in pitch attitude. There is very little lag in the indications of the airspeed indicator. If, while making attitude changes, you notice some lag between control application and change of airspeed, it is most likely due to cyclic control lag. Generally, a departure from the desired airspeed, due to an inadvertent pitch attitude change, also results in a change in altitude. For example, an increase in airspeed due to a low pitch attitude results in a decrease in altitude. A correction in the pitch attitude regains both airspeed and altitude.

**Bank Control**

The bank attitude of a helicopter is the angular relation of its lateral axis and the natural horizon. To maintain a straight course in visual flight, you must keep the lateral axis of the helicopter level with the natural horizon. Assuming the helicopter is in **coordinated** flight, any deviation from a laterally level attitude produces a turn. [Figure 6-4]

*Attitude Indicator*

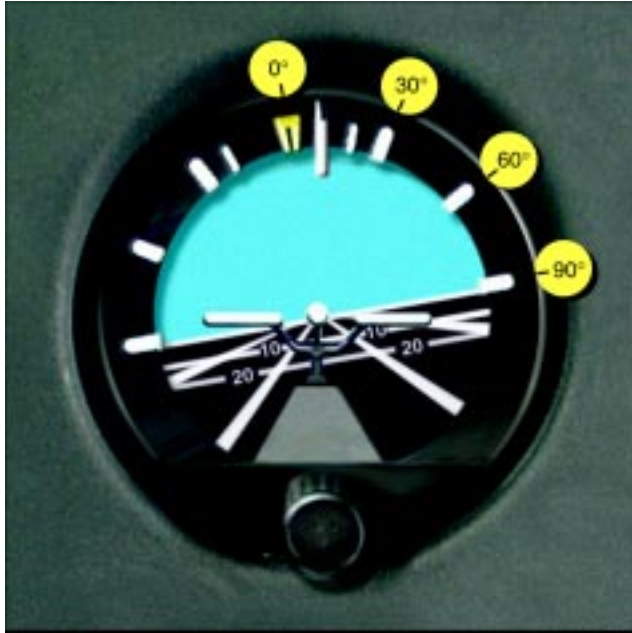
The attitude indicator gives a direct indication of the bank attitude of the helicopter. For instrument flight, the miniature aircraft and the horizon bar of the attitude indicator are substituted for the actual helicopter and the natural horizon. Any change in bank attitude of the helicopter is indicated instantly by the miniature aircraft. For proper interpretations of this instrument, you should imagine being in the miniature aircraft. If the helicopter is properly trimmed and the rotor tilts, a turn begins. The turn can be stopped by leveling the miniature aircraft with the horizon bar. The ball in the turn-and-slip indicator should always be kept centered through proper pedal trim.

The angle of bank is indicated by the pointer on the banking scale at the top of the instrument. [Figure 6-5] Small bank angles which may not be seen by observing the miniature aircraft, can easily be determined by referring to the banking scale pointer.



**Figure 6-4.** The flight instruments used for bank control are the attitude, heading, and turn indicators.

**Coordinated:** Using the controls to maintain or establish various conditions of flight with (1) a minimum disturbance of the forces maintaining equilibrium, or (2) the control action necessary to effect the smoothest changes in equilibrium.



**Figure 6-5.** The banking scale at the top of the attitude indicator indicates varying degrees of bank. In this example, the helicopter is banked a little over 10° to the right.

Pitch-and-bank attitudes can be determined simultaneously on the attitude indicator. Even though the miniature aircraft is not level with the horizon bar, pitch attitude can be established by observing the relative position of the miniature aircraft and the horizon bar.

The attitude indicator may show small misrepresentations of bank attitude during maneuvers which involve turns. This **precession** error can be immediately detected by closely cross-checking the other bank instruments during these maneuvers. Precession normally is noticed when rolling out of a turn. If, on the completion of a turn, the miniature aircraft is level and the helicopter is still turning, make a small change of bank attitude to center the turn needle and stop the movement of the heading indicator.

### *Heading Indicator*

In coordinated flight, the heading indicator gives an indirect indication of the helicopter's bank attitude. When a helicopter is banked, it turns. When the lateral axis of the helicopter is level, it flies straight. Therefore, in coordinated flight, when

**Precession:** The characteristic of a gyroscope that causes an applied force to be felt, not at the point of application, but 90° from that point in the direction of rotation.

the heading indicator shows a constant heading, the helicopter is level laterally. A deviation from the desired heading indicates a bank in the direction the helicopter is turning. A small angle of bank is indicated by a slow change of heading; a large angle of bank is indicated by a rapid change of heading. If a turn is noticed, apply opposite cyclic until the heading indicator indicates the desired heading, simultaneously checking that the ball is centered. When making the correction to the desired heading, you should not use a bank angle greater than that required to achieve a standard-rate turn. In addition, if the number of degrees of change is small, limit the bank angle to the number of degrees to be turned. Bank angles greater than these require more skill and precision in attaining the desired results. During straight-and-level flight, the heading indicator is the primary reference for bank control.

### *Turn Indicator*

During coordinated flight, the needle of the turn-and-slip indicator gives an indirect indication of the bank attitude of the helicopter. When the needle is displaced from the vertical position, the helicopter is turning in the direction of the displacement. Thus, if the needle is displaced to the left, the helicopter is turning left. Bringing the needle back to the vertical position with the cyclic produces straight flight. A close observation of the needle is necessary to accurately interpret small deviations from the desired position.

Cross-check the ball of the turn-and-slip indicator to determine that the helicopter is in coordinated flight. If the rotor is laterally level and torque is properly compensated for by pedal pressure, the ball remains in the center. To center the ball, level the helicopter laterally by reference to the other bank instruments, then center the ball with pedal trim. Torque correction pressures vary as you make power changes. Always check the ball following such changes.

### **Common Errors During Straight-and-Level Flight**

1. Failure to maintain altitude.
2. Failure to maintain heading.
3. Overcontrolling pitch and bank during corrections.
4. Failure to maintain proper pedal trim.
5. Failure to cross-check all available instruments.



### **Power Control During Straight-and-Level Flight**

Establishing specific power settings is accomplished through collective pitch adjustments and throttle control, where necessary. For reciprocating powered helicopters, power indications are observed on the manifold pressure gauge. For turbine powered helicopters, power is observed on the torque gauge. (Since most instrument flight rules (IFR)-certified helicopters are turbine powered, this discussion concentrates on this type of helicopter.)

At any given airspeed, a specific power setting determines whether the helicopter is in level flight, in a climb, or in a descent. For example, cruising airspeed maintained with cruising power results in level flight. If you increase the power setting and hold the airspeed constant, the helicopter climbs. Conversely, if you decrease power and hold the airspeed constant, the helicopter descends. As a rule of thumb, in a turbine-engine powered helicopter, a 10 to 15 percent change in the torque value required to maintain level flight results in a climb or descent of approximately 500 fpm, if the airspeed remains the same.

If the altitude is held constant, power determines the airspeed. For example, at a constant altitude, cruising power results in cruising airspeed. Any deviation from the cruising power setting results in a change of airspeed. When power is added to increase airspeed, the nose of the helicopter pitches up and yaws to the right in a helicopter with a counterclockwise main rotor blade rotation. When power is reduced to decrease airspeed, the nose pitches down and yaws to the left. The yawing effect is most pronounced in single-rotor helicopters, and is absent in helicopters with counter-rotating rotors. To counteract the yawing tendency of the helicopter, apply pedal trim during power changes.

To maintain a constant altitude and airspeed in level flight, coordinate pitch attitude and power control. The relationship between altitude and airspeed determines the need for a change in power and/or pitch attitude. If the altitude is constant and the airspeed is high or low, change the power to obtain the desired airspeed. During the change in power, make an accurate interpretation of the altimeter; then counteract any deviation from the desired altitude by an appropriate change of pitch attitude. If the altitude is low and the airspeed is high, or vice versa, a change in pitch attitude alone may

return the helicopter to the proper altitude and airspeed. If both airspeed and altitude are low, or if both are high, a change in both power and pitch attitude is necessary.

To make power control easy when changing airspeed, it is necessary to know the approximate power settings for the various airspeeds which will be flown. When the airspeed is to be changed any appreciable amount, adjust the torque so that it is approximately 5 percent over or under that setting necessary to maintain the new airspeed. As the power approaches the desired setting, include the torque meter in the cross-check to determine when the proper adjustment has been accomplished. As the airspeed is changing, adjust the pitch attitude to maintain a constant altitude. A constant heading should be maintained throughout the change. As the desired airspeed is approached, adjust power to the new cruising power setting and further adjust pitch attitude to maintain altitude. **Overpowering** and **underpowering** torque approximately 5 percent results in a change of airspeed at a moderate rate, which allows ample time to adjust pitch and bank smoothly. The instrument indications for straight-and-level flight at normal cruise, and during the transition from normal cruise to slow cruise are illustrated in figures 6-6 and 6-7. After the airspeed has stabilized at slow cruise, the attitude indicator shows an approximate level pitch attitude.

The altimeter is the primary pitch instrument during level flight, whether flying at a constant airspeed, or during a change in airspeed. Altitude should not change during airspeed transitions. The heading indicator remains the primary bank instrument. Whenever the airspeed is changed any appreciable amount, the torque meter is momentarily the primary instrument for power control. When the airspeed approaches that desired, the airspeed indicator again becomes the primary instrument for power control.

The cross-check of the pitch-and-bank instruments to produce straight-and-level flight should be combined with the power control instruments. With a constant power setting, a normal cross-check should be satisfactory. When changing power, the speed of the cross-check must be increased to cover the pitch-and-bank instruments adequately. This is necessary to counteract any deviations immediately.

**Overpowering:** Using more power than required for the purpose of achieving a faster rate of airspeed change.

**Underpowering:** Using less power than required for the purpose of achieving a faster rate of airspeed change.



**Figure 6-6.** Flight instrument indications in straight-and-level flight at normal cruise speed.



**Figure 6-7.** Flight instrument indications in straight-and-level flight with airspeed decreasing.

### Common Errors During Airspeed Changes

1. Improper use of power.
2. Overcontrolling pitch attitude.
3. Failure to maintain heading.
4. Failure to maintain altitude.
5. Improper pedal trim.

### Straight Climbs (Constant Airspeed and Constant Rate)

For any power setting and load condition, there is only one airspeed which will give the most efficient rate of climb. To determine this, you should consult the climb data for the type of helicopter being flown. The **technique** varies according to the airspeed on entry and whether you want to make a constant-airspeed or constant-rate climb.

#### Entry

To enter a constant-airspeed climb from cruise airspeed, when the climb speed is lower than cruise speed, simultaneously increase power to the climb power setting and adjust pitch

attitude to the approximate climb attitude. The increase in power causes the helicopter to start climbing and only very slight back cyclic pressure is needed to complete the change from level to climb attitude. The attitude indicator should be used to accomplish the pitch change. If the transition from level flight to a climb is smooth, the vertical speed indicator shows an immediate upward trend and then stops at a rate appropriate to the stabilized airspeed and attitude. Primary and supporting instruments for climb entry are illustrated in figure 6-8.

When the helicopter stabilizes on a constant airspeed and attitude, the airspeed indicator becomes primary for pitch. The torque meter continues to be primary for power and should be monitored closely to determine if the proper climb power setting is being maintained. Primary and supporting instruments for a stabilized constant-airspeed climb are shown in figure 6-9.

The technique and procedures for entering a constant-rate climb are very similar to those previously described for a constant-airspeed climb. For training purposes, a constant-



Figure 6-8. Flight instrument indications during climb entry for a constant-airspeed climb.

**Technique:** The manner or style in which the procedures are executed.



**Figure 6-9.** Flight instrument indications in a stabilized, constant-air-speed climb.

rate climb is entered from climb airspeed. The rate used is the one that is appropriate for the particular helicopter being flown. Normally, in helicopters with low climb rates, 500 fpm is appropriate, in helicopters capable of high climb rates, use a rate of 1,000 fpm.

To enter a constant-rate climb, increase power to the approximate setting for the desired rate. As power is applied, the airspeed indicator is primary for pitch until the vertical speed approaches the desired rate. At this time, the vertical speed indicator becomes primary for pitch. Change pitch attitude by reference to the attitude indicator to maintain the desired vertical speed. When the vertical speed indicator becomes primary for pitch, the airspeed indicator becomes primary for power. Primary and supporting instruments for a stabilized constant-rate climb are illustrated in figure 6-10. Adjust power to maintain desired airspeed. Pitch attitude and power corrections should be closely coordinated. To illustrate this, if the vertical speed is correct but the airspeed is low, add power. As power is increased, it may be necessary to lower the pitch attitude slightly to avoid increasing the vertical

rate. Adjust the pitch attitude smoothly to avoid overcontrolling. Small power corrections usually will be sufficient to bring the airspeed back to the desired indication.

#### **Level-Off**

The level-off from a constant-air-speed climb must be started before reaching the desired altitude. Although the amount of lead varies with the helicopter being flown and your piloting technique, the most important factor is vertical speed. As a rule of thumb, use 10 percent of the vertical velocity as your lead point. For example, if the rate of climb is 500 fpm, initiate the level-off approximately 50 feet before the desired altitude. When the proper lead altitude is reached, the altimeter becomes primary for pitch. Adjust the pitch attitude to the level flight attitude for that airspeed. Cross-check the altimeter and vertical speed indicator to determine when level flight has been attained at the desired altitude. To level off at cruise airspeed, if this speed is higher than climb airspeed, leave the power at the climb power setting until the airspeed approaches cruise airspeed, then reduce it to the cruise power setting.



**Figure 6-10.** Flight instrument indications in a stabilized constant-rate climb.

The level-off from a constant-rate climb is accomplished in the same manner as the level-off from a constant-air-speed climb.

### **Straight Descents (Constant Airspeed and Constant Rate)**

A descent may be performed at any normal airspeed the helicopter is capable of, but the airspeed must be determined prior to entry. The technique is determined by whether you want to perform a constant-air-speed or a constant-rate descent.

#### **Entry**

If your airspeed is higher than descending airspeed, and you wish to make a constant-air-speed descent at the descending airspeed, reduce power to the descending power setting and maintain a constant altitude using cyclic pitch control. When you approach the descending airspeed, the airspeed indicator becomes primary for pitch, and the torque meter is primary for power. As you hold the airspeed constant, the helicopter begins to descend. For a constant-rate descent, reduce the power to the approximate setting for the desired rate. If the

descent is started at the descending airspeed, the airspeed indicator is primary for pitch until the vertical speed indicator approaches the desired rate. At this time, the vertical speed indicator becomes primary for pitch, and the airspeed indicator becomes primary for power. Coordinate power and pitch attitude control as was described earlier for constant-rate climbs.

#### **Level-Off**

The level-off from a constant-air-speed descent may be made at descending airspeed or at cruise airspeed, if this is higher than descending airspeed. As in a climb level-off, the amount of lead depends on the rate of descent and control technique. For a level-off at descending airspeed, the lead should be approximately 10 percent of the vertical speed. At the lead altitude, simultaneously increase power to the setting necessary to maintain descending airspeed in level flight. At this point, the altimeter becomes primary for pitch, and the airspeed indicator becomes primary for power.

To level off at a higher airspeed than descending airspeed, increase the power approximately 100 to 150 feet prior to reaching the desired altitude. The power setting should be

that which is necessary to maintain the desired airspeed in level flight. Hold the vertical speed constant until approximately 50 feet above the desired altitude. At this point, the altimeter becomes primary for pitch, and the airspeed indicator becomes primary for power. The level-off from a constant-rate descent should be accomplished in the same manner as the level-off from a constant-airspeed descent.

### Common Errors During Straight Climbs and Descents

1. Failure to maintain heading.
2. Improper use of power.
3. Poor control of pitch attitude.
4. Failure to maintain proper pedal trim.
5. Failure to level off on desired altitude.

### Turns

When making turns by reference to the flight instruments, they should be made at a precise rate. Turns described in this chapter are those which do not exceed a standard rate of

3° per second as indicated on the turn-and-slip indicator. True airspeed determines the angle of bank necessary to maintain a standard-rate turn. A rule of thumb to determine the approximate angle of bank required for a standard-rate turn is to divide your airspeed by 10 and add one-half the result. For example, at 60 knots, approximately 9° of bank is required ( $60 \div 10 = 6 + 3 = 9$ ); at 80 knots, approximately 12° of bank is needed for a standard-rate turn.

To enter a turn, apply lateral cyclic in the direction of the desired turn. The entry should be accomplished smoothly, using the attitude indicator to establish the approximate bank angle. When the turn indicator indicates a standard-rate turn, it becomes primary for bank. The attitude indicator now becomes a supporting instrument. During level turns, the altimeter is primary for pitch, and the airspeed indicator is primary for power. Primary and supporting instruments for a stabilized standard-rate turn are illustrated in figure 6-11. If an increase in power is required to maintain airspeed, slight forward cyclic pressure may be required since the helicopter tends to pitch up as collective pitch angle is increased. Apply pedal trim, as required, to keep the ball centered.



Figure 6-11. Flight instrument indications for a standard-rate turn to the left.

To recover to straight-and-level flight, apply cyclic in the direction opposite the turn. The rate of roll-out should be the same as the rate used when rolling into the turn. As you initiate the turn recovery, the attitude indicator becomes primary for bank. When the helicopter is approximately level, the heading indicator becomes primary for bank as in straight-and-level flight. Cross-check the airspeed indicator and ball closely to maintain the desired airspeed and pedal trim.

### Turns to a Predetermined Heading

A helicopter turns as long as its lateral axis is tilted; therefore, the recovery must start before the desired heading is reached. The amount of lead varies with the rate of turn and your piloting technique.

As a guide, when making a  $3^\circ$  per second rate of turn, use a lead of one-half the bank angle. For example, if you are using a  $12^\circ$  bank angle, use half of that, or  $6^\circ$ , as the lead point prior to your desired heading. Use this lead until you are able to determine the exact amount required by your particular technique. The bank angle should never exceed the number of degrees to be turned. As in any standard-rate turn, the rate of recovery should be the same as the rate for entry. During turns to predetermined headings, cross-check the primary and supporting pitch, bank, and power instruments closely.

### Timed Turns

A timed turn is a turn in which the clock and turn-and-slip indicator are used to change heading a definite number of degrees in a given time. For example, using a standard-rate turn, a helicopter turns  $45^\circ$  in 15 seconds. Using a half-standard-rate turn, the helicopter turns  $45^\circ$  in 30 seconds. Timed turns can be used if your heading indicator becomes inoperative.

Prior to performing timed turns, the turn coordinator should be **calibrated** to determine the accuracy of its indications. To do this, establish a standard-rate turn by referring to the turn-and-slip indicator. Then as the sweep second hand of the clock passes a cardinal point (12, 3, 6, or 9), check the heading on the heading indicator. While holding the indicated rate of turn constant, note the heading changes at 10-second intervals. If the helicopter turns more or less than 30 degrees in that interval, a smaller or larger deflection of the needle is

necessary to produce a standard-rate turn. When you have calibrated the turn-and-slip indicator during turns in each direction, note the corrected deflections, if any, and apply them during all timed turns.

You use the same cross-check and control technique in making timed turns that you use to make turns to a predetermined heading, except that you substitute the clock for the heading indicator. The needle of the turn-and-slip indicator is primary for bank control, the altimeter is primary for pitch control, and the airspeed indicator is primary for power control. Begin the roll-in when the clock's second hand passes a cardinal point, hold the turn at the calibrated standard-rate indication, or half-standard-rate for small changes in heading, and begin the roll-out when the computed number of seconds has elapsed. If the roll-in and roll-out rates are the same, the time taken during entry and recovery need not be considered in the time computation.

If you practice timed turns with a full instrument panel, check the heading indicator for the accuracy of your turns. If you execute the turns without the heading indicator, use the magnetic compass at the completion of the turn to check turn accuracy, taking compass deviation errors into consideration.

### Change of Airspeed in Turns

Changing airspeed in turns is an effective maneuver for increasing your proficiency in all three basic instrument skills. Since the maneuver involves simultaneous changes in all components of control, proper execution requires a rapid cross-check and interpretation, as well as smooth control. Proficiency in the maneuver also contributes to your confidence in the instruments during attitude and power changes involved in more complex maneuvers.

Pitch and power control techniques are the same as those used during airspeed changes in straight-and-level flight. As discussed previously, the angle of bank necessary for a given rate of turn is proportional to the true airspeed. Since the turns are executed at standard rate, the angle of bank must be varied in direct proportion to the airspeed change in order to maintain a constant rate of turn. During a reduction of airspeed, you must decrease the angle of bank and increase the pitch attitude to maintain altitude and a standard-rate turn.

**Calibrated:** The instrument indication was compared with a standard value to determine the accuracy of the instrument.

The altimeter and the needle on the turn indicator should remain constant throughout the turn. The altimeter is primary for pitch control, and the turn needle is primary for bank control. The torque meter is primary for power control while the airspeed is changing. As the airspeed approaches the new indication, the airspeed indicator becomes primary for power control.

Two methods of changing airspeed in turns may be used. In the first method, airspeed is changed after the turn is established. In the second method, the airspeed change is initiated simultaneously with the turn entry. The first method is easier, but regardless of the method used, the rate of cross-check must be increased as you reduce power. As the helicopter decelerates, check the altimeter and vertical speed indicator for needed pitch changes, and the bank instruments for needed bank changes. If the needle of the turn-and-slip indicator shows a deviation from the desired deflection, change the bank. Adjust pitch attitude to maintain altitude. When the airspeed approaches that desired, the airspeed indicator becomes primary for power control. Adjust the torque meter to maintain the desired airspeed. Use pedal trim to ensure the maneuver is coordinated.

Until your control technique is very smooth, frequently cross-check the attitude indicator to keep from overcontrolling and to provide approximate bank angles appropriate for the changing airspeeds.

### **Compass Turns**

The use of gyroscopic heading indicators make heading control very easy. However, if the heading indicator fails or your helicopter does not have one installed, you must use the magnetic compass for heading reference. When making compass-only turns, you need to adjust for the lead or lag created by acceleration and deceleration errors so that you roll out on the desired heading. When turning to a heading of north, the lead for the roll-out must include the number of degrees of your latitude plus the lead you normally use in recovery from turns. During a turn to a south heading, maintain the turn until the compass passes south the number of degrees of your latitude, minus your normal roll-out lead. For example, when turning from an easterly direction to north, where the latitude is 30°, start the roll-out when the compass

reads 037° (30° plus one-half the 15° angle of bank, or whatever amount is appropriate for your rate of roll-out). When turning from an easterly direction to south, start the roll-out when the magnetic compass reads 203° (180° plus 30° minus one-half the angle of bank). When making similar turns from a westerly direction, the appropriate points at which to begin your roll-out would be 323° for a turn to north, and 157° for a turn to south.

### **30° Bank Turn**

A turn using 30° of bank is seldom necessary, or advisable, in instrument meteorological conditions (IMC) and is considered an unusual attitude in a helicopter. However, it is an excellent maneuver to increase your ability to react quickly and smoothly to rapid changes of attitude. Even though the entry and recovery technique are the same as for any other turn, you will probably find it more difficult to control pitch because of the decrease in vertical lift as the bank increases. Also, because of the decrease in vertical lift, there is a tendency to lose altitude and/or airspeed. Therefore, to maintain a constant altitude and airspeed, additional power is required. You should not initiate a correction, however, until the instruments indicate the need for one. During the maneuver, note the need for a correction on the altimeter and vertical speed indicator, then check the indications on the attitude indicator, and make the necessary adjustments. After you have made this change, again check the altimeter and vertical speed indicator to determine whether or not the correction was adequate.

### **Climbing and Descending Turns**

For climbing and descending turns, the techniques described earlier for straight climbs and descents and those for standard-rate turns are combined. For practice, start the climb or descent and turn simultaneously. The primary and supporting instruments for a stabilized constant airspeed left climbing turn are illustrated in figure 6-12. The level-off from a climbing or descending turn is the same as the level-off from a straight climb or descent. To return to straight-and-level flight, you may stop the turn and then level off, level off and then stop the turn, or simultaneously level off and stop the turn. During climbing and descending turns, keep the ball of the turn indicator centered with pedal trim.





**Figure 6-12.** Flight instrument indications for a stabilized left climbing turn at a constant airspeed.

**Common Errors During Turns**

1. Failure to maintain desired turn rate.
2. Failure to maintain altitude in level turns.
3. Failure to maintain desired airspeed.
4. Variation in the rate of entry and recovery.
5. Failure to use proper lead in turns to a heading.
6. Failure to properly compute time during timed turns.
7. Failure to use proper leads and lags during the compass turns.
8. Improper use of power.
9. Failure to use proper pedal trim.

**Unusual Attitudes**

Any maneuver not required for normal helicopter instrument flight is an unusual attitude and may be caused by any one or a combination of factors such as turbulence, disorientation,

instrument failure, confusion, preoccupation with cockpit duties, carelessness in cross-checking, errors in instrument interpretation, or lack of proficiency in aircraft control. Due to the instability characteristics of the helicopter, unusual attitudes can be extremely critical. As soon as you detect an unusual attitude, make a recovery to straight-and-level flight as soon as possible with a minimum loss of altitude.

To recover from an unusual attitude, correct bank-and-pitch attitude, and adjust power as necessary. All components are changed almost simultaneously, with little lead of one over the other. You must be able to perform this task with and without the attitude indicator. If the helicopter is in a climbing or descending turn, correct bank, pitch, and power. The bank attitude should be corrected by referring to the turn-and-slip indicator and attitude indicator. Pitch attitude should be corrected by reference to the altimeter, airspeed indicator, vertical speed indicator, and attitude indicator. Adjust power by referring to the airspeed indicator and torque meter.

Since the displacement of the controls used in recoveries from unusual attitudes may be greater than those for normal flight, take care in making adjustments as straight-and-level flight is approached. Cross-check the other instruments closely to avoid overcontrolling.

### **Common Errors During Unusual Attitude Recoveries**

1. Failure to make proper pitch correction.
2. Failure to make proper bank correction.
3. Failure to make proper power correction.
4. Overcontrolling pitch and/or bank attitude.
5. Overcontrolling power.
6. Excessive loss of altitude.

### **Emergencies**

Emergencies under instrument flight are handled similarly to those occurring during VFR flight. A thorough knowledge of the helicopter and its systems, as well as good aeronautical knowledge and judgment, prepares you to better handle emergency situations. Safe operations begin with preflight planning and a thorough preflight inspection. Plan your route of flight so there are adequate landing sites in the event you have to make an emergency landing. Make sure you have all your resources, such as maps, publications, flashlights, and fire extinguishers readily available for use in an emergency.

During any emergency, you should first fly the aircraft. This means that you should make sure the helicopter is under control, including the determination of emergency landing sites. Then perform the emergency checklist memory items, followed by written items in the rotorcraft flight manual (RFM). Once all these items are under control, you should notify air traffic control (ATC). Declare any emergency on the last assigned ATC frequency, or if one was not issued, transmit on the emergency frequency 121.5. Set the transponder to the emergency squawk code 7700. This code triggers an alarm or a special indicator in radar facilities.

Most in-flight emergencies, including low fuel and a complete electrical failure, require you to **land as soon as possible**. In the event of an electrical fire, turn all nonessential equipment off and **land immediately**. Some essential electrical

**Land as soon as possible:** Land without delay at the nearest suitable area, such as an open field, at which a safe approach and landing is assured.

**Land immediately:** The urgency of the landing is paramount. The primary consideration is to ensure the survival of the occupants. Landing in trees, water, or other unsafe areas should be considered only as a last resort.

instruments, such as the attitude indicator, may be required for a safe landing. A navigation radio failure may not require an immediate landing as long as the flight can continue safely. In this case, you should **land as soon as practical**. ATC may be able to provide vectors to a safe landing area. For the specific details on what to do during an emergency, you should refer to the RFM for the helicopter you are flying.

### **Autorotations**

Both straight-ahead and turning autorotations should be practiced by reference to instruments. This training will ensure that you can take prompt corrective action to maintain positive aircraft control in the event of an engine failure.

To enter autorotation, reduce collective pitch smoothly to maintain a safe rotor RPM and apply pedal trim to keep the ball of the turn-and-slip indicator centered. The pitch attitude of the helicopter should be approximately level as shown by the attitude indicator. The airspeed indicator is the primary pitch instrument and should be adjusted to the recommended autorotation speed. The heading indicator is primary for bank in a straight-ahead autorotation. In a turning autorotation, a standard-rate turn should be maintained by reference to the needle of the turn-and-slip indicator.

### *Common Errors During Autorotations*

1. Uncoordinated entry due to improper pedal trim.
2. Poor airspeed control due to improper pitch attitude.
3. Poor heading control in straight-ahead autorotations.
4. Failure to maintain proper rotor RPM.
5. Failure to maintain a standard-rate turn during turning autorotations.

### **Servo Failure**

Most helicopters certified for single-pilot IFR flight are required to have autopilots, which greatly reduces pilot workload. If an autopilot servo fails, however, you have to resume manual control of the helicopter. How much your workload increases, depends on which servo fails. If a cyclic servo fails, you may want to land immediately as the workload increases tremendously. If an antitorque or collective servo fails, you might be able to continue to the next suitable landing site.

**Land as soon as practical:** The landing site and duration of flight are at the discretion of the pilot. Extended flight beyond the nearest approved landing area is not recommended.

## Instrument Takeoff

The procedures and techniques described here should be modified, as necessary, to conform with those set forth in the operating instructions for the particular helicopter being flown. During training, **instrument takeoffs** should not be attempted except when receiving instruction from an appropriately certificated, proficient flight instructor pilot.

Adjust the miniature aircraft in the attitude indicator, as appropriate, for the aircraft being flown. After the helicopter is aligned with the runway or takeoff pad, to prevent forward movement of a helicopter equipped with a wheel-type landing gear, set the parking brakes or apply the toe brakes. If the parking brake is used, it must be unlocked after the takeoff has been completed. Apply sufficient friction to the collective pitch control to minimize overcontrolling and to prevent creeping. Excessive friction should be avoided since this limits collective pitch movement.

After checking all instruments for proper indications, start the takeoff by applying collective pitch and a predetermined power setting. Add power smoothly and steadily to gain airspeed and altitude simultaneously and to prevent settling to the ground. As power is applied and the helicopter becomes airborne, use the antitorque pedals initially to maintain the

desired heading. At the same time, apply forward cyclic to begin accelerating to climbing airspeed. During the initial acceleration, the pitch attitude of the helicopter, as read on the attitude indicator, should be one to two bar widths low. The primary and supporting instruments after becoming airborne are illustrated in figure 6-13. As the airspeed increases to the appropriate climb airspeed, adjust pitch gradually to climb attitude. As climb airspeed is reached, reduce power to the climb power setting and transition to a fully coordinated straight climb.

During the initial climb out, minor heading corrections should be made with pedals only until sufficient airspeed is attained to transition to fully coordinated flight. Throughout the instrument takeoff, instrument cross-check and interpretations must be rapid and accurate, and aircraft control positive and smooth.

### Common Errors During Instrument Takeoffs

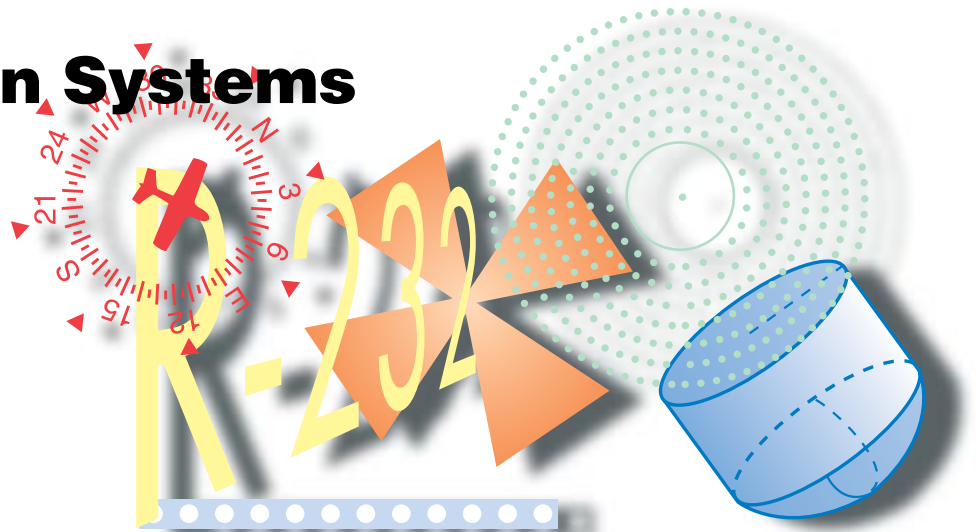
1. Failure to maintain heading.
2. Overcontrolling pedals.
3. Failure to use required power.
4. Failure to adjust pitch attitude as climbing airspeed is reached.



**Figure 6-13.** Flight instrument indications during an instrument takeoff.

**Instrument takeoff:** Using the instruments rather than outside visual cues to maintain runway heading and execute a safe takeoff.

# Navigation Systems



## Introduction

This chapter provides the basic radio principles applicable to navigation equipment, as well as an operational knowledge of how to use these systems in instrument flight. This information provides the framework for all instrument procedures, including departure procedures (DPs), holding patterns, and approaches, because each of these maneuvers consist mainly of accurate attitude instrument flying and accurate tracking using navigation systems.

## Basic Radio Principles

A **radio wave** is an electromagnetic wave (EM wave) with frequency characteristics that make it useful in radio. The wave will travel long distances through space (in or out of the atmosphere) without losing too much strength. The antenna is used to convert it from an electric current into a radio wave so it can travel through space to the receiving antenna which converts it back into an electric current.

## How Radio Waves Propagate

All matter has a varying degree of conductivity or resistance to radio waves. The Earth itself acts as the greatest resistor to radio waves. Radiated energy that travels near the ground induces a voltage in the ground that subtracts energy from the wave, decreasing the strength of the wave as the distance

from the antenna becomes greater. Trees, buildings, and mineral deposits affect the strength to varying degrees. Radiated energy in the upper atmosphere is likewise affected as the energy of radiation is absorbed by molecules of air, water, and dust. The characteristics of radio wave propagation vary according to the signal frequency, and the design, use, and limitations of the equipment.

## Ground Wave

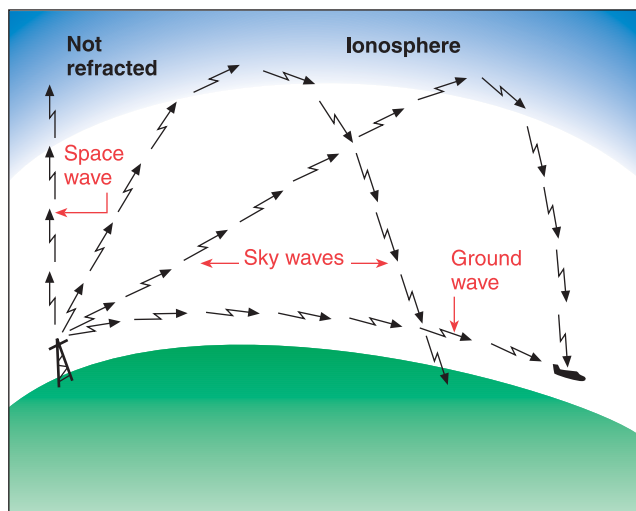
The ground wave travels across the surface of the Earth. You can best imagine the ground wave's path as being in a tunnel or alley bounded by the surface of the Earth and by the ionosphere, which keeps it from going out into space. Generally, the lower the frequency, the farther the signal will travel.

Ground waves are usable for navigation purposes because they reliably and predictably travel the same route, day after day, and are not influenced by too many outside factors. The ground wave frequency range is generally from the lowest frequencies in the radio range (perhaps as low as 100 Hz) up to approximately 1,000 kHz (1 MHz). Although there is a ground wave component to frequencies above this, even to 30 MHz, the ground wave at these higher frequencies loses strength over very short distances.

**Radio wave:** An electromagnetic wave (EM wave) with frequency characteristics useful for radio transmission.

## Sky Wave

The sky wave, at frequencies of 1 to 30 MHz, is good for long distances because these frequencies are refracted or “bent” by the ionosphere, causing the signal to be sent back to Earth from high in the sky and received great distances away. [Figure 7-1] Used by high frequency (HF) radios in aircraft, messages can be sent across oceans using only 50 to 100 watts of power. Frequencies that produce a sky wave are not used for navigation because the pathway of the signal from transmitter to receiver is highly variable. The wave is “bounced” off of the ionosphere, which is always changing due to the varying amount of the sun’s radiation reaching it (night/day and seasonal variations, sunspot activity, etc.). The sky wave is not reliable for navigation purposes.



**Figure 7-1.** Ground, space, and sky wave propagation.

For aeronautical communication purposes, the sky wave (HF) is about 80 to 90 percent reliable. HF is being gradually replaced by satellite communication which is more reliable.

## Space Wave

Radio waves of 15 MHz and above (all the way up to many GHz), when able to pass through the ionosphere, are considered space waves. Most navigation systems operate with their signals propagating as space waves. Frequencies above 100 MHz have nearly no ground or sky wave components. They are space waves, but (except for global positioning system (GPS)) the navigation signal is used before

it reaches the ionosphere so the effect of the ionosphere, which can cause some propagation errors, is minimal. GPS errors caused by passage through the ionosphere are significant and are corrected for by the GPS receiver system.

Space waves have another characteristic of concern to users. Space waves reflect off hard objects and may be blocked if the object is between the transmitter and the receiver. Site and terrain error, as well as **propeller/rotor modulation error** in very-high omnidirectional range (VOR) systems is caused by this bounce. Instrument landing system (ILS) course distortion is also the result of this phenomenon, which led to the need for establishment of ILS **critical areas**.

Generally, space waves are “line of sight” receivable, but those of lower frequencies will “bend” over the horizon somewhat. Since the VOR signal at 108 to 118 MHz is a lower frequency than distance measuring equipment (DME) at 962 to 1213 MHz, when an aircraft is flown “over the horizon” from a VOR/DME station, the DME will normally be the first to stop functioning.

## Disturbances to Radio Wave Reception

Static distorts the radio wave and interferes with normal reception of communications and navigation signals. Low-frequency airborne equipment such as automatic direction finder (ADF) and long range navigation (LORAN) are particularly subject to static disturbance. Using very-high frequency (VHF) and ultra-high frequency (UHF) frequencies avoids many of the discharge noise effects. Static noise heard on navigation or communication radio frequencies may be a warning of interference with navigation instrument displays. Some of the problems caused by precipitation static (P-static) are:

- Complete loss of VHF communications.
- Erroneous magnetic compass readings.
- Aircraft flies with one wing low while using the autopilot.
- High-pitched squeal on audio.
- Motorboat sound on audio.
- Loss of all avionics.
- Very-low frequency (VLF) navigation system inoperative.
- Erratic instrument readouts.
- Weak transmissions and poor radio reception.
- St. Elmo’s Fire.

**Propeller/rotor modulation error:** Certain propeller RPM settings or helicopter rotor speeds can cause the VOR course deviation indicator (CDI) to fluctuate as much as  $\pm 6^\circ$ . Pilots should check for this phenomenon prior to reporting a VOR station or aircraft equipment for unsatisfactory operation.

**Critical areas:** Most ILS installations are subject to signal interference by surface vehicles, aircraft, or both. As a result, areas are established near each localizer and glide-slope antenna so air traffic control (ATC) can steer aircraft away from these areas.

## Nondirectional Radio Beacon (NDB)

### Description

The nondirectional beacon (NDB) is a ground-based radio transmitter that transmits radio energy in all directions. The ADF, when used with an NDB, determines the bearing from the aircraft to the transmitting station. The indicator may be mounted in a separate instrument in the aircraft panel. [Figure 7-2] The ADF needle points to the NDB ground station to determine the **relative bearing (RB)** to the transmitting station. **Magnetic heading (MH)** plus RB equals the **magnetic bearing (MB)** to the station.



Figure 7-2. ADF indicator instrument and receiver.

### NDB Components

The ground equipment, the NDB, transmits in the frequency range of 190 to 535 kHz. Most ADFs will also tune the AM broadcast band frequencies above the NDB band (550 to 1650 kHz). However, these frequencies are not approved for navigation because stations do not continuously identify themselves, and they are much more susceptible to sky wave propagation especially from dusk to dawn. NDB stations are capable of voice transmission and are often used for transmitting the automated weather observing system (AWOS). The aircraft must be in operational range of the NDB. Coverage depends on the strength of the transmitting

**Relative bearing:** The number of degrees measured clockwise between the heading of the aircraft and the direction from which the bearing is taken.

**Magnetic heading (MH):** The direction an aircraft is pointed with respect to magnetic north.

station. Before relying on ADF indications, identify the station by listening to the Morse code identifier. NDB stations are usually two letters or an alpha-numeric combination.

### ADF Components

The airborne equipment includes two antennas, a receiver, and the indicator instrument. The “sense” antenna (non-directional) receives signals with nearly equal efficiency from all directions. The “loop” antenna receives signals better from two directions (bidirectional). When the loop and sense antenna inputs are processed together in the ADF radio, the result is the ability to receive a radio signal well in all directions but one, thus resolving all directional ambiguity.

The indicator instrument can be one of three kinds: the fixed-card ADF, movable-card ADF, or the radio magnetic indicator (RMI). The fixed-card ADF (also known as the relative bearing indicator (RBI)), always indicates zero at the top of the instrument, and the needle indicates the RB to the station. Figure 7-3 indicates an RB of 135°, and if the MH is 45°, the MB to the station is 180°. (MH + RB = MB to the station.)

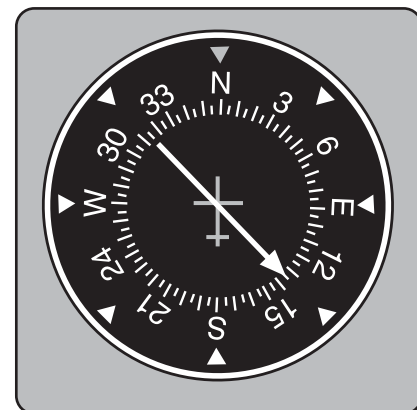
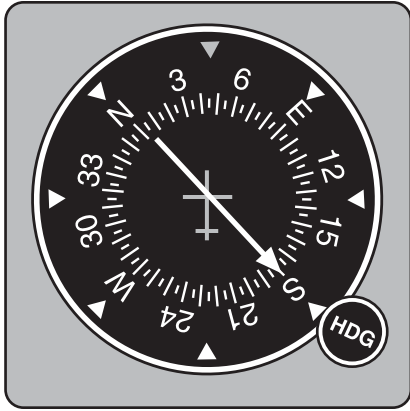


Figure 7-3. Relative bearing (RB) on a fixed-card indicator.

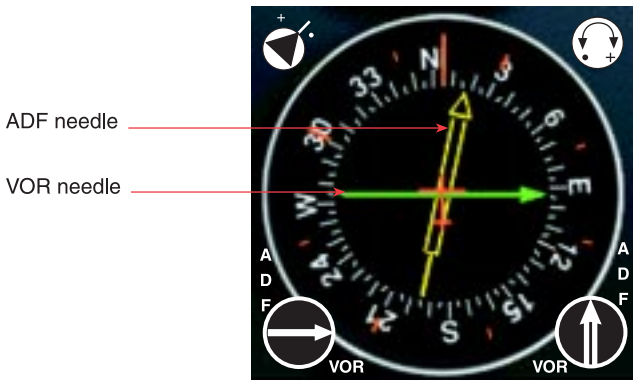
The movable-card ADF allows the pilot to rotate the aircraft’s present heading to the top of the instrument so that the head of the needle indicates MB to the station, and the tail indicates MB from the station. Figure 7-4 indicates a heading of 45°, the MB to the station is 180°, and the MB from the station is 360°.

**Magnetic bearing (MB):** The direction to or from a radio transmitting station measured relative to magnetic north.



**Figure 7-4.** Relative bearing (RB) on a movable-card indicator.

The RMI differs from the movable-card ADF in that it automatically rotates the azimuth card (remotely controlled by a gyrocompass) to represent aircraft heading. The RMI has two needles, which can be used to indicate navigation information from either the ADF or the VOR receivers. When a needle is being driven by the ADF, the head of the needle indicates the MB TO the station tuned on the ADF receiver. The tail of the needle is the bearing FROM the station. When a needle of the RMI is driven by a VOR receiver, the needle indicates where the aircraft is radially with respect to the VOR station. The needle points to the bearing TO the station, as read on the azimuth card. The tail of the needle points to the radial of the VOR the aircraft is currently on or crossing. Figure 7-5 indicates a heading of 005°, the MB to the station is 015°, and the MB from the station is 195°.



**Figure 7-5.** Radio magnetic indicator (RMI).

## Function of ADF

The ADF can be used to plot your position, track inbound and outbound, and intercept a bearing. These procedures are used to execute holding patterns and nonprecision instrument approaches.

### Orientation

The ADF needle points TO the station, regardless of aircraft heading or position. The RB indicated is thus the angular relationship between the aircraft heading and the station, measured clockwise from the nose of the aircraft. Think of the nose/tail and left/right needle indications, visualizing the ADF dial in terms of the longitudinal axis of the aircraft. When the needle points to 0°, the nose of the aircraft points directly to the station; with the pointer on 210°, the station is 30° to the left of the tail; with the pointer on 090°, the station is off the right wingtip. The RB does not by itself indicate aircraft position. The RB must be related to aircraft heading in order to determine direction to or from the station.

### Station Passage

When you are near the station, slight deviations from the desired track result in large deflections of the needle. Therefore, it is important to establish the correct drift correction angle as soon as possible. Make small heading corrections (not over 5°) as soon as the needle shows a deviation from course, until it begins to rotate steadily toward a wingtip position or shows erratic left/right oscillations. You are abeam a station when the needle points to the 90° or 270° position. Hold your last corrected heading constant, and time station passage when the needle shows either wingtip position or settles at or near the 180° position. The time interval from the first indications of station proximity to positive station passage varies with altitude—a few seconds at low levels to 3 minutes at high altitude.

### Homing

The ADF may be used to “home” in on a station. **Homing** is flying the aircraft on any heading required to keep the needle pointing directly to the 0° RB position. To home into a station, tune the station, identify the Morse code signal, then turn the aircraft to bring the ADF azimuth needle to the 0° RB position. Turns should be made using the heading indicator. When the turn is complete, check the ADF needle and make small corrections as necessary.

**Homing:** Flying the aircraft on any heading required to keep the needle pointing directly to the 0° RB position.

Figure 7-6 illustrates homing starting from an initial MH of 050° and an RB of 300°, indicating a 60° left turn is needed to produce an RB of zero. Turn left, rolling out at 50° minus 60° equals 350°. Small heading corrections are then made to zero the ADF needle.

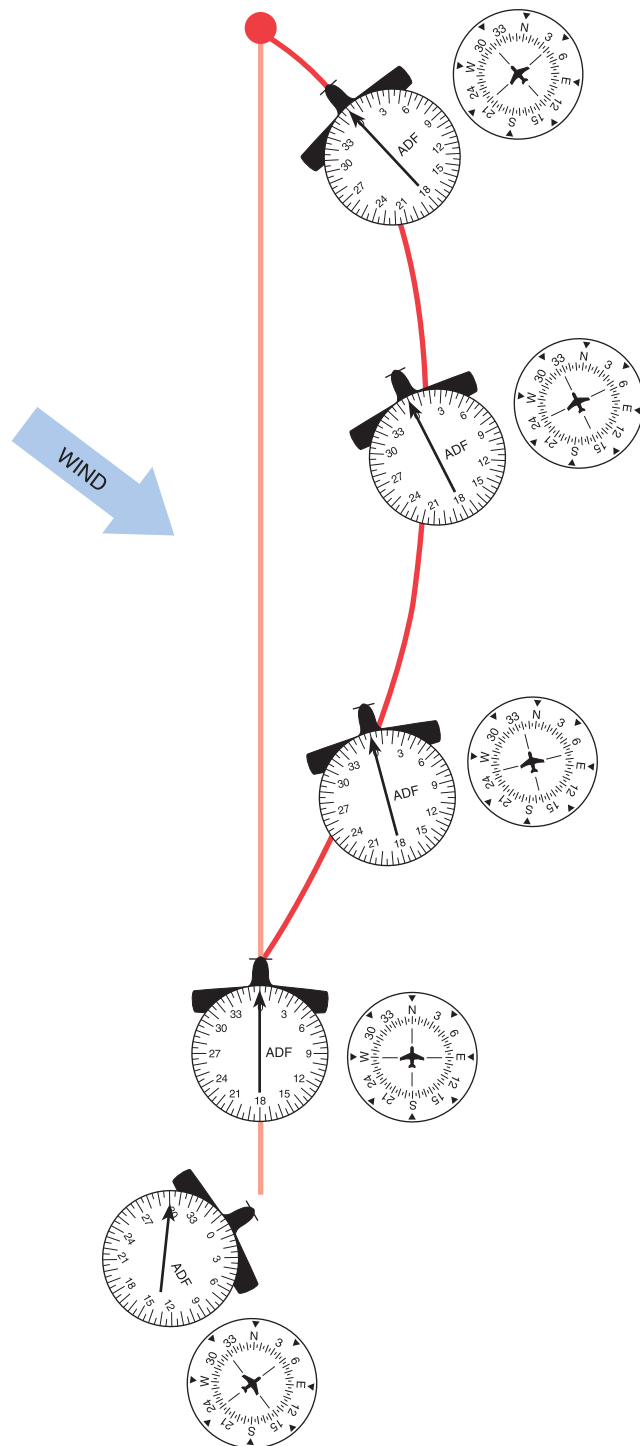
If there is no wind, the aircraft will home to the station on a direct track over the ground. With a crosswind, the aircraft will follow a circuitous path to the station on the downwind side of the direct track to the station.

### Tracking

**Tracking** uses a heading that will maintain the desired track to or from the station regardless of crosswind conditions. Interpretation of the heading indicator and needle is done to maintain a constant MB to or from the station.

To track inbound, turn to the heading that will produce a zero RB. Maintain this heading until off-course drift is indicated by displacement of the needle, which will occur if there is a crosswind (needle moving left = wind from the left; needle moving right = wind from the right). A rapid rate of bearing change with a constant heading indicates either a strong crosswind or proximity to the station, or both. When there is a definite (2° to 5°) change in needle reading, turn in the direction of needle deflection to intercept the initial MB. The angle of interception must be greater than the number of degrees of drift. The intercept angle depends on the rate of drift, the aircraft speed, and station proximity. Initially, it is standard to double the RB when turning toward your course.

For example, if your heading equals your course and the needle points 10° left, turn 20° left. [Figure 7-7] When the needle is deflected 20° (deflection = interception angle), track has been intercepted. The aircraft is on track as long as the RB remains the same number of degrees as the **wind correction angle (WCA)**. Lead the interception to avoid overshooting the track. Turn 10° toward the inbound course. You are now inbound with a 10° left correction angle.

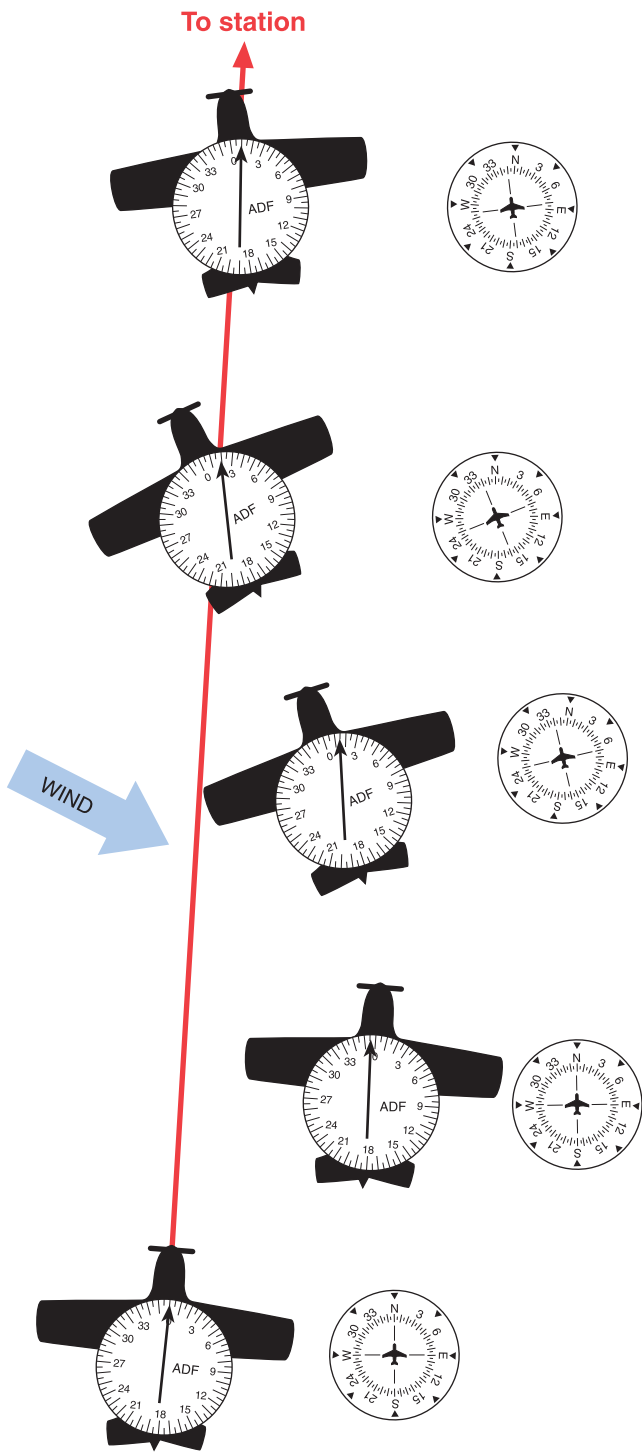


**Figure 7-6.** ADF homing with a crosswind.

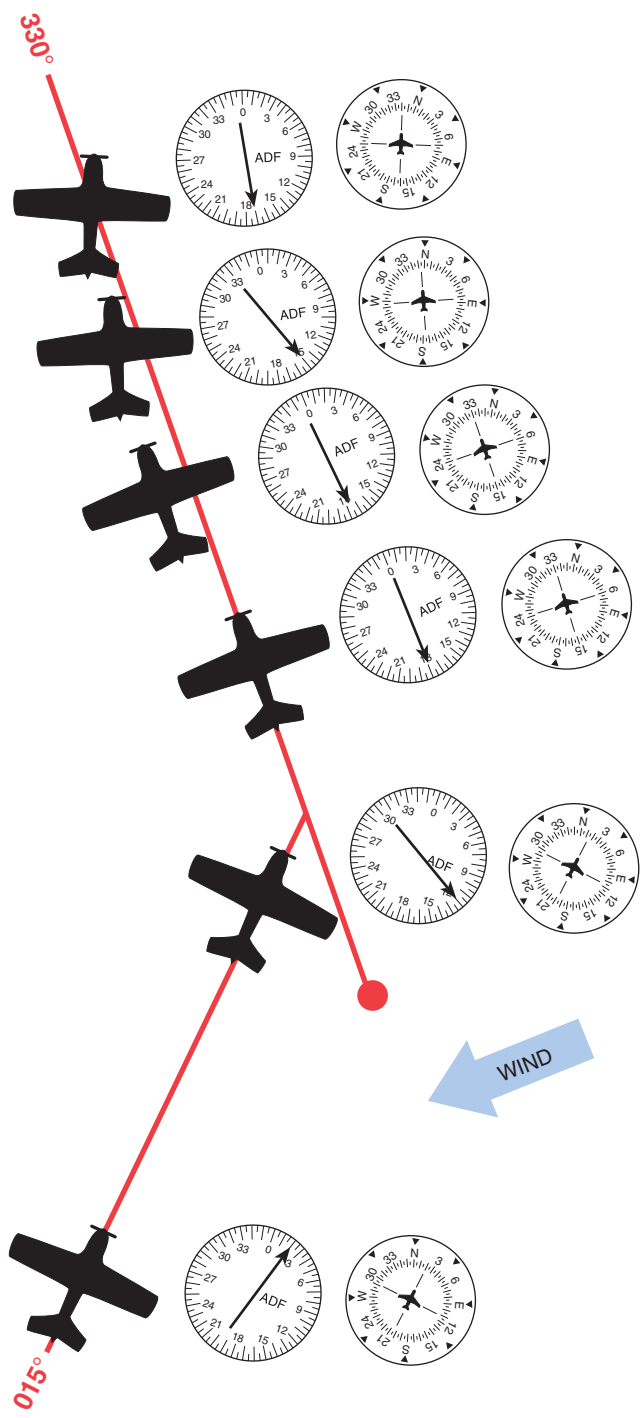
**Tracking:** Flying a heading that will maintain the desired track to or from the station regardless of crosswind conditions.

**Wind correction angle (WCA):** The angle between the desired track and the heading of the aircraft necessary to keep the aircraft tracking over the desired track.





**Figure 7-7.** ADF tracking inbound.



**Figure 7-8.** ADF interception and tracking outbound.

Note that in figure 7-7, for the aircraft closest to the station, the WCA is 10° left and the RB is 10° right. If those values do not change, the aircraft will track directly to the station. If you observe off-course deflection in the original direction, turn again to the original interception heading. When the desired course has been re-intercepted, turn 5° toward the inbound course, proceeding inbound with a 15° drift correction. If the initial 10° drift correction is excessive, as shown by needle deflection away from the wind, turn to parallel the desired course and let the wind drift you back on course. When the needle is again zeroed, turn into the wind with a reduced drift correction angle.

To track outbound, the same principles apply: needle moving left = wind from the left, needle moving right = wind from the right. Wind correction is made toward the needle deflection. The only exception is that, while the turn to establish the WCA is being made, the direction of the azimuth needle deflections is reversed. When tracking inbound, needle deflection decreases while turning to establish the WCA, and needle deflection increases when tracking outbound. Note the example of course interception and outbound tracking in figure 7-8.

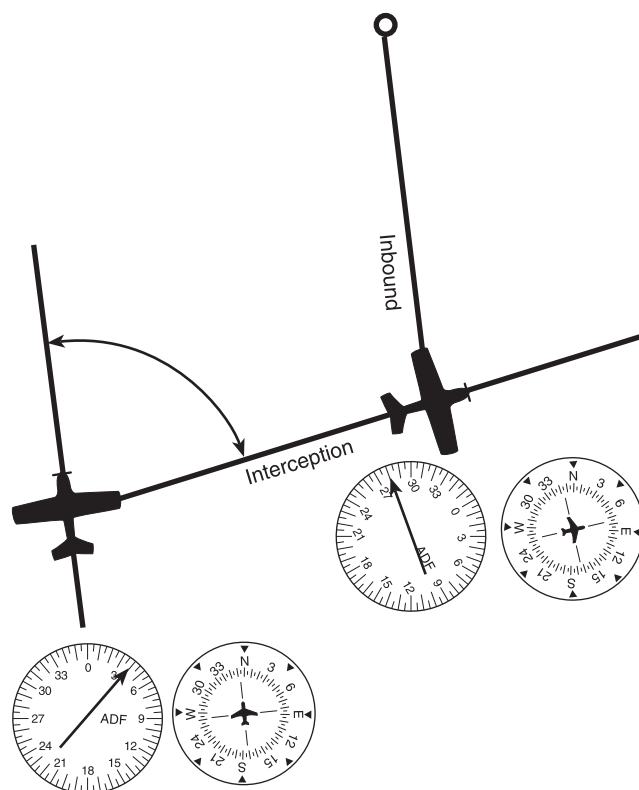
### Intercepting Bearings

ADF orientation and tracking procedures may be applied to intercept a specified inbound or outbound MB. To intercept an *inbound* bearing of 355°, the following steps may be used. [Figure 7-9]

1. Determine your position in relation to the station by paralleling the desired inbound bearing. Turn to a heading of 355°.
2. Note whether the station is to the right or left of the nose position. Determine the number of degrees of needle deflection from the zero position, and double this amount for the interception angle. The needle is indicating a 40° RB to the right.
3. Turn the aircraft toward the desired MB the number of degrees determined for the interception angle. Turn right 80° to a heading of 75°.
4. Maintain the interception heading until the needle is deflected the same number of degrees from the zero position as the angle of interception (minus lead appropriate to the rate of bearing change).

5. Turn inbound and continue with tracking procedures. If the needle is pointing in front of your intercept angle, you have not reached the bearing to be intercepted. If it points behind the intercept position, you have passed your bearing.

Interception of an outbound MB can be accomplished by the same procedures as for the inbound intercept, except that it is necessary to substitute the 180° position for the zero position on the needle.



**Figure 7-9.** Interception of bearing.

### Operational Errors of ADF

Some of the common pilot-induced errors associated with ADF navigation are listed below, to help you avoid making the same mistakes. The errors are:

1. Improper tuning and station identification. Many pilots have made the mistake of homing or tracking to the wrong station.

2. Positively identifying any malfunctions of the RMI slaving system or ignoring the warning flag.
3. Dependence on homing rather than proper tracking. This commonly results from sole reliance on the ADF indications, rather than correlating them with heading indications.
4. Poor orientation, due to failure to follow proper steps in orientation and tracking.
5. Careless interception angles, very likely to happen if you rush the initial orientation procedure.
6. Overshooting and undershooting predetermined MBs, often due to forgetting the course interception angles used.
7. Failure to maintain selected headings. Any heading change is accompanied by an ADF needle change. The instruments must be read in combination before any interpretation is made.
8. Failure to understand the limitations of the ADF and the factors that affect its use.
9. Overcontrolling track corrections close to the station (chasing the ADF needle), due to failure to understand or recognize station approach.
10. Failure to keep heading indicator set so it agrees with magnetic compass.

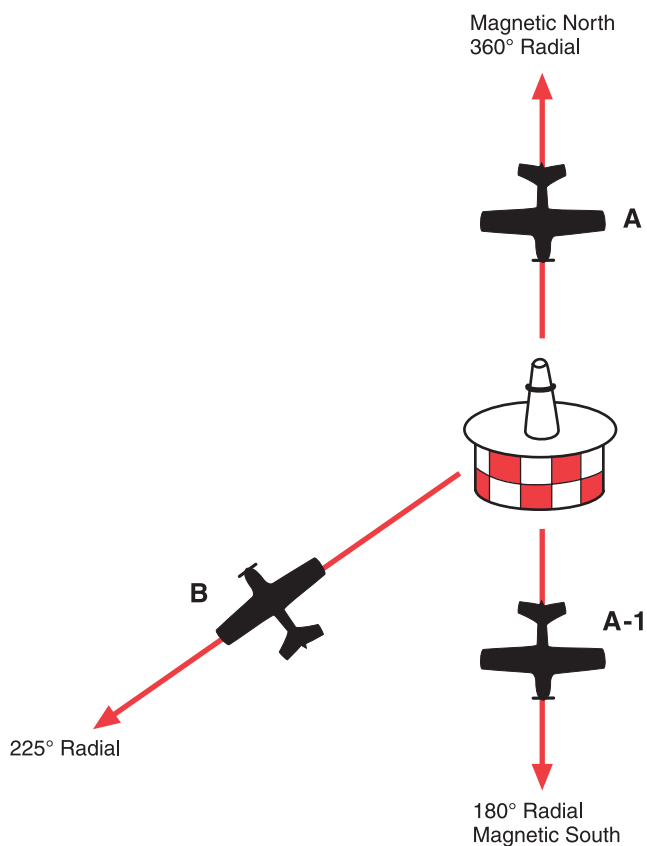
## Very-High Frequency Omnidirectional Range (VOR)

### Description

VOR is the primary navigational aid (NAVAID) used by civil aviation in the National Airspace System (NAS). The VOR ground station is oriented to magnetic north and transmits azimuth information to the aircraft, providing 360 courses TO or FROM the VOR station. When DME is installed with the VOR, it is referred to as a VOR/DME and provides both azimuth and distance information. When military tactical air navigation (TACAN) equipment is installed with the VOR, it is known as a VORTAC and provides both azimuth and distance information.

The courses oriented FROM the station are called **radials**. The VOR information received by an aircraft is not influenced by aircraft attitude or heading. [Figure 7-10] For example, aircraft A (heading 180°) is inbound on the 360° radial; after

crossing the station, the aircraft is outbound on the 180° radial at A-1. Aircraft B is shown crossing the 225° radial. Similarly, at any point around the station, an aircraft can be located somewhere on a VOR radial.



**Figure 7-10.** VOR radials.

The VOR receiver measures and presents information to indicate bearing TO or FROM the station. In addition to the navigation signals transmitted by the VOR, a Morse code signal is transmitted concurrently to identify the facility, as well as voice transmissions for communication and relay of weather and other information.

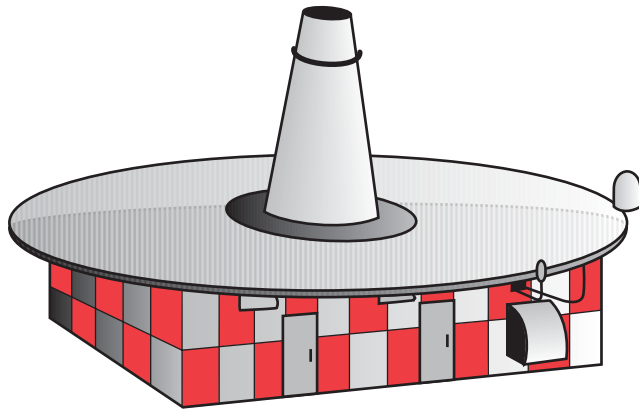
VORs are classified according to their operational uses. The standard VOR facility has a power output of approximately 200 watts, with a maximum usable range depending upon the aircraft altitude, class of facility, location and siting of

**Radials:** The courses oriented FROM the station.

the facility, terrain conditions within the usable area of the facility, and other factors. Above and beyond certain altitude and distance limits, signal interference from other VOR facilities and a weak signal make it unreliable. Coverage is typically at least 40 miles at normal minimum instrument flight rules (IFR) altitudes. VORs with accuracy problems in parts of their service volume are listed in Notices to Airmen (NOTAMs) and in the Airport/Facility Directory (A/FD) under the name of the NAVAID.

### VOR Components

The ground equipment consists of a VOR ground station, which is a small, low building topped with a flat white disc, upon which are located the VOR antennas and a fiberglass cone-shaped tower. [Figure 7-11] The station includes an automatic monitoring system. The monitor automatically turns off defective equipment and turns on the standby transmitter. Generally, the accuracy of the signal from the ground station is within 1°.

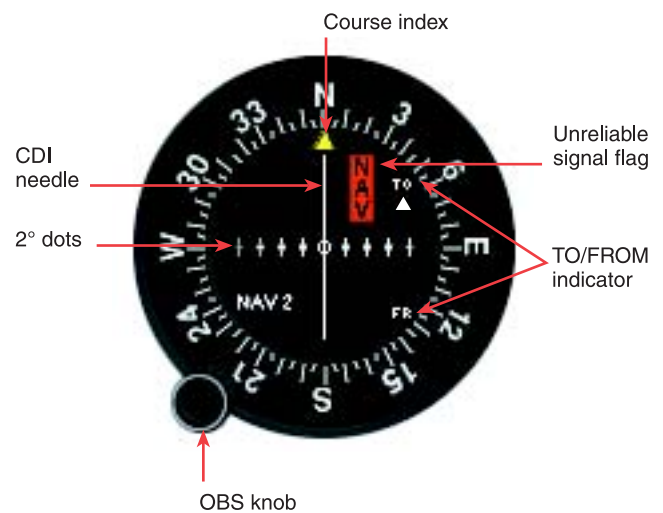


**Figure 7-11.** VOR transmitter (ground station).

VOR facilities are aurally identified by Morse code, or voice, or both. The VOR can be used for ground-to-air communication without interference with the navigation signal. VOR facilities operate within the 108.0 to 117.95 MHz frequency band and assignment between 108.0 and 112.0 MHz is in even-tenth decimals to preclude any conflict with ILS localizer frequency assignment, which uses the odd tenths in this range.

The airborne equipment includes an antenna, a receiver, and the indicator instrument. The receiver has a frequency knob to select any of the frequencies between 108.0 to 117.95 MHz. The ON/OFF/volume control turns on the navigation receiver and controls the audio volume. The volume has no effect on the operation of the receiver. You should listen to the station identifier before relying on the instrument for navigation.

VOR indicator instruments have at least the essential components shown in the instrument illustrated in figure 7-12.



**Figure 7-12.** The VOR indicator instrument.

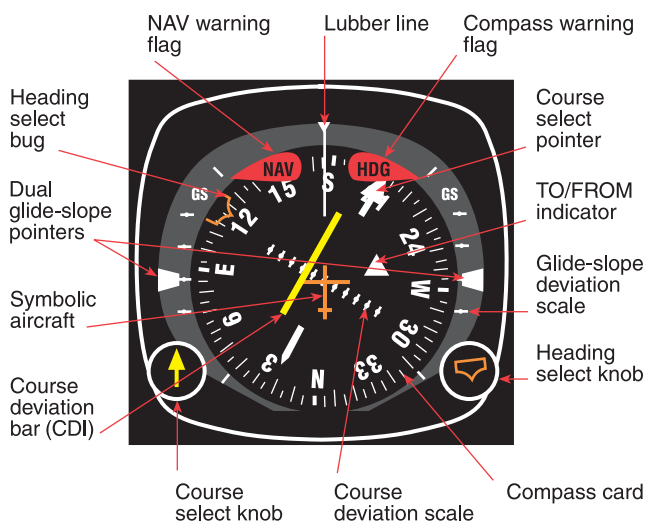
*Omnibearing Selector (OBS).* The desired course is selected by turning the OBS knob until the course is aligned with the course index mark or displayed in the course window.

*Course deviation indicator (CDI).* The deviation indicator is composed of an instrument face and a needle hinged to move laterally across the instrument face. The needle centers when the aircraft is on the selected radial or its reciprocal. Full needle deflection from the center position to either side of the dial indicates the aircraft is 10° or more off course, assuming normal needle sensitivity. The outer edge of the center circle is 2° off course; each dot signifies another 2°.

**TO/FROM indicator.** The TO/FROM indicator shows whether the selected course will take the aircraft TO or FROM the station. It does *not* indicate whether the aircraft is *heading* to or from the station.

**Flags, or other signal strength indicators.** The device that indicates a usable or an unreliable signal may be an “OFF” flag. It retracts from view when signal strength is sufficient for reliable instrument indications. Alternately, insufficient signal strength may be indicated by a blank or OFF in the TO/FROM window.

The indicator instrument may also be a **horizontal situation indicator (HSI)** which combines the heading indicator and CDI. [Figure 7-13] The combination of navigation information from VOR/Localizer (LOC) or from LORAN or GPS, with aircraft heading information provides a visual picture of the aircraft’s location and direction. This decreases pilot workload especially with tasks such as course intercepts, flying a back-course approach, or holding pattern entry. (See Chapter 3, for operational characteristics.)



**Figure 7-13.** Horizontal situation indicator (HSI).

**Horizontal situation indicator (HSI):** A flight navigation instrument that combines the heading indicator with a CDI, in order to provide the pilot with better situational awareness of location with respect to the courseline.

## Function of VOR

### Orientation

The VOR does not account for the aircraft heading, it only relays the aircraft direction from the station and will have the same indications regardless of which way the nose is pointing. Tune the VOR receiver to the appropriate frequency of the selected VOR ground station, turn up the audio volume, and identify the station’s signal audibly. Then rotate the OBS to center the CDI needle, and read the course under or over the index.

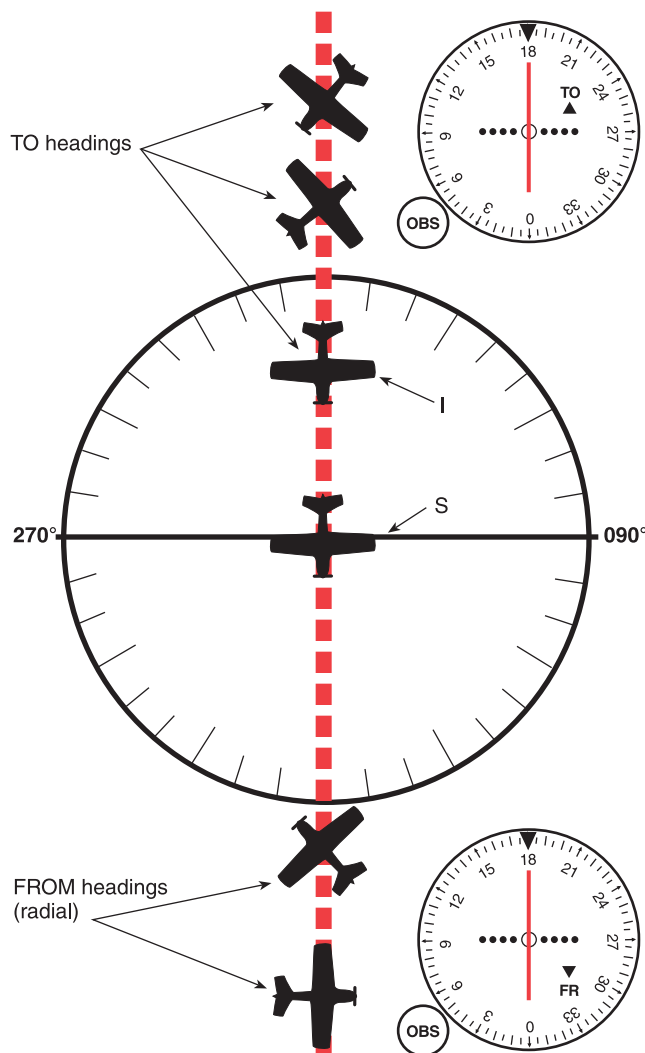
In figure 7-12, 360° TO is the course indicated, while in figure 7-14, 180° TO is the course. The latter indicates that the aircraft (which may be heading in any direction) is, at this moment, located at any point on the 360° radial (line from the station) except directly over the station or very close to it, as in points I to S in figure 7-14. The CDI will deviate from side to side as the aircraft passes over or nearly over the station because of the volume of space above the station where the **zone of confusion** exists. This zone of confusion is caused by lack of adequate signal directly above the station due to the radiation pattern of the station’s antenna, and because the resultant of the opposing reference and variable signals is small and constantly changing.

The CDI in figure 7-14 indicates 180°, meaning that the aircraft is on the 180° or the 360° radial of the station. The TO/FROM indicator resolves the ambiguity. If the TO indicator is showing, then it is 180° TO the station. The FROM indication indicates the radial of the station the aircraft is presently on. Movement of the CDI from center, if it occurs at a relatively constant rate, indicates the aircraft is moving or drifting off the 180°/360° line. If the movement is rapid or fluctuating, this is an indication of impending station passage (the aircraft is near the station). To determine the aircraft’s position relative to the station, rotate the OBS until FROM appears in the window, then center the CDI needle. The index indicates the VOR radial where the aircraft is located. The inbound (to the station) course is the reciprocal of the radial.

If you set the VOR to the reciprocal of your course, the CDI will reflect **reverse sensing**. To correct for needle deflection, you will need to fly away from the needle. To avoid this reverse sensing situation, set the VOR to agree with your intended course.

**Zone of confusion:** Volume of space above the station where a lack of adequate navigation signal directly above the VOR station causes the needle to deviate.

**Reverse sensing:** When the VOR needle indicates the reverse of normal operation. This occurs when the aircraft is headed toward the station with a FROM indication or when the aircraft is headed away from the station with a TO indication.



**Figure 7-14.** CDI interpretation.

A single NAVAID will only allow you to determine your position relative to a radial. You need to cross-reference the indications from a second NAVAID in order to narrow your position down to an exact location on this radial.

### *Tracking TO and FROM the Station*

To track to the station, rotate the OBS until TO appears, then center the CDI. Fly the course indicated by the index. If the CDI moves off center to the left, follow the needle by correcting course to the left, beginning with a 20° correction.

When you are flying the course indicated on the index, a left deflection of the needle indicates a crosswind component from the left. If the amount of correction brings the needle back to center, decrease the left course correction by half. If the CDI moves left or right now, it should do so much slower, and you can make a smaller heading correction for the next iteration.

Keeping the CDI centered will take the aircraft to the station. To track to the station, the OBS value at the index is not changed. To home to the station, the CDI needle is periodically centered, and the new course under the index is used for the aircraft heading. Homing will follow a circuitous route to the station, just as with ADF homing.

To track FROM the station on a VOR radial, you should first orient the aircraft's location with respect to the station and the desired outbound track by centering the CDI needle with a FROM indication. The track is intercepted by either flying over the station or establishing an intercept heading. The magnetic course of the desired radial is entered under the index using the OBS and the intercept heading held until the CDI centers. Then the procedure for tracking to the station is used to fly outbound on the specified radial.

### *Course Interception*

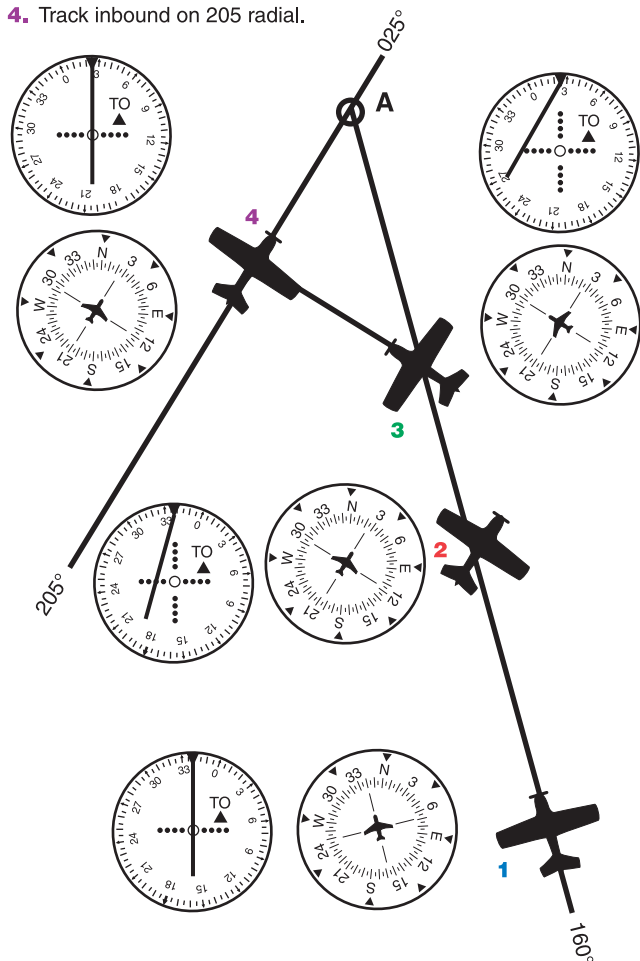
If your desired course is not the one you are flying, you must first orient yourself with respect to the VOR station and the course to be flown, and then establish an intercept heading. The following steps may be used to intercept a predetermined course, either inbound or outbound. Steps 1-3 may be omitted if you turn directly to intercept the course without initially turning to parallel the desired course.

1. Turn to a heading to parallel the desired course, in the same direction as the course to be flown.
2. Determine the difference between the radial to be intercepted and the radial on which you are located.
3. Double the difference to determine the interception angle, which will not be less than 20° nor greater than 90°.
4. Rotate the OBS to the desired radial or inbound course.
5. Turn to the interception heading.
6. Hold this heading constant until the CDI centers, which indicates the aircraft is on course. (With practice in judging the varying rates of closure with the course centerline, you learn to lead the turn to prevent overshooting the course.)
7. Turn to the MH corresponding to the selected course, and follow tracking procedures inbound or outbound.

Course interception is illustrated in figure 7-15.

To intercept a course of 025°, inbound of VOR A:

1. Present position, inbound on 160 radial.
2. Turn right to parallel inbound course.  $025^\circ - 180^\circ = 205^\circ$ ,  $205 - 160 = 45^\circ$  (double 45 for interception angle of  $90^\circ$ ). Turn to  $295^\circ$  ( $205^\circ + 90^\circ$ ).
3. Maintain heading of  $295^\circ$  until 205 radial is intercepted (OBS 025, needle centered).
4. Track inbound on 205 radial.



**Figure 7-15.** Course interception (VOR).

### VOR Operational Errors

Typical pilot-induced errors include:

1. Careless tuning and identification of station.
2. Failure to check receiver for accuracy/sensitivity.
3. Turning in the wrong direction during an orientation. This error is common until you visualize *position* rather than *heading*.
4. Failure to check the ambiguity (TO/FROM) indicator, particularly during course reversals, resulting in reverse sensing and corrections in the wrong direction.

5. Failure to parallel the desired radial on a track interception problem. Without this step, orientation to the desired radial can be confusing. Since you think in left/right terms, aligning your aircraft position to the radial/course is essential.
6. Overshooting and undershooting radials on interception problems.
7. Overcontrolling corrections during tracking, especially close to the station.
8. Misinterpretation of station passage. On VOR receivers equipped without an ON/OFF flag, a voice transmission on the combined communication and navigation radio (NAV/COM) in use for VOR may cause the same TO/FROM fluctuations on the ambiguity meter as shown during station passage. Read the whole receiver—TO/FROM, CDI, and OBS—before you make a decision. Do not utilize a VOR reading observed while transmitting.
9. Chasing the CDI, resulting in homing instead of tracking. Careless heading control and failure to bracket wind corrections makes this error common.

### VOR Accuracy

The effectiveness of the VOR depends upon proper use and adjustment of both ground and airborne equipment.

The accuracy of course alignment of the VOR is generally plus or minus  $1^\circ$ . On some VORs, minor course roughness may be observed, evidenced by course needle or brief flag alarm. At a few stations, usually in mountainous terrain, the pilot may occasionally observe a brief course needle oscillation, similar to the indication of “approaching station.” Pilots flying over unfamiliar routes are cautioned to be on the alert for these vagaries, and in particular, to use the TO/FROM indicator to determine positive station passage.

Certain propeller revolutions per minute (RPM) settings or helicopter rotor speeds can cause the VOR CDI to fluctuate as much as plus or minus  $6^\circ$ . Slight changes to the RPM setting will normally smooth out this roughness. Pilots are urged to check for this modulation phenomenon prior to reporting a VOR station or aircraft equipment for unsatisfactory operation.

### VOR Receiver Accuracy Check

VOR system course sensitivity may be checked by noting the number of degrees of change as you rotate the OBS to move the CDI from center to the last dot on either side. The course selected should not exceed  $10^\circ$  or  $12^\circ$  either side. In addition, Title 14 of the Code of Federal Regulations

(14 CFR) part 91 provides for certain VOR equipment accuracy checks, and an appropriate endorsement, within 30 days prior to flight under IFR. To comply with this requirement and to ensure satisfactory operation of the airborne system, use the following means for checking VOR receiver accuracy:

1. VOT or a radiated test signal from an appropriately rated radio repair station.
2. Certified checkpoints on the airport surface.
3. Certified airborne checkpoints.

### *VOT*

The Federal Aviation Administration (FAA) **VOR test facility (VOT)** transmits a test signal which provides users a convenient means to determine the operational status and accuracy of a VOR receiver while on the ground where a VOT is located. Locations of VOTs are published in the A/FD. Two means of identification are used. One is a series of dots and the other is a continuous tone. Information concerning an individual test signal can be obtained from the local flight service station (FSS.) The airborne use of VOT is permitted; however, its use is strictly limited to those areas/altitudes specifically authorized in the A/FD or appropriate supplement.

To use the VOT service, tune in the VOT frequency 108.0 MHz on the VOR receiver. With the CDI centered, the OBS should read 0° with the TO/FROM indication showing FROM or the OBS should read 180° with the TO/FROM indication showing TO. Should the VOR receiver operate an RMI, it will indicate 180° on any OBS setting.

A radiated VOT from an appropriately rated radio repair station serves the same purpose as an FAA VOT signal, and the check is made in much the same manner as a VOT with some differences.

The frequency normally approved by the Federal Communications Commission (FCC) is 108.0 MHz; however, repair stations are not permitted to radiate the VOR test signal continuously. The owner or operator of the aircraft must make arrangements with the repair station to have the test signal transmitted. A representative of the repair station must make an entry into the aircraft logbook or other permanent record certifying to the radial accuracy and the date of transmission.

**VOR test facility (VOT):** A ground facility which emits a test signal to check VOR receiver accuracy. Some VOTs are available to the user while airborne, while others are limited to ground use only.

### *Certified Checkpoints*

Airborne and ground checkpoints consist of certified radials that should be received at specific points on the airport surface or over specific landmarks while airborne in the immediate vicinity of the airport. Locations of these checkpoints are published in the A/FD.

Should an error in excess of plus or minus 4° be indicated through use of a ground check, or plus or minus 6° using the airborne check, IFR flight shall not be attempted without first correcting the source of the error. No correction other than the correction card figures supplied by the manufacturer should be applied in making these VOR receiver checks.

If a dual system VOR (units independent of each other except for the antenna) is installed in the aircraft, one system may be checked against the other. Turn both systems to the same VOR ground facility and note the indicated bearing to that station. The maximum permissible variations between the two indicated bearings is 4°.

## **Distance Measuring Equipment (DME)**

### **Description**

When used in conjunction with the VOR system, DME makes it possible for pilots to determine an accurate geographic position of the aircraft, including the bearing and distance TO or FROM the station. The aircraft DME transmits interrogating radio frequency (RF) pulses, which are received by the DME antenna at the ground facility. The signal triggers ground receiver equipment to respond back to the interrogating aircraft. The airborne DME equipment measures the elapsed time between the interrogation signal sent by the aircraft and reception of the reply pulses from the ground station. This time measurement is converted into nautical miles (NMs) distance from the station.

Some DME receivers provide a groundspeed in knots by monitoring the rate of change of the aircraft's position relative to the ground station. Groundspeed values are only accurate when tracking directly to or from the station.

### **DME Components**

VOR/DME, VORTAC, ILS/DME, and LOC/DME navigation facilities established by the FAA provide course and distance information from collocated components under a frequency pairing plan. DME operates on frequencies in the UHF spectrum between 962 MHz and 1213 MHz. Aircraft receiving equipment which provides for automatic DME



selection assures reception of azimuth and distance information from a common source when designated VOR/DME, VORTAC, ILS/DME, and LOC/DME are selected. Some aircraft have separate VOR and DME receivers each of which must be tuned to the appropriate navigation facility.

The airborne equipment includes an antenna and a receiver.

The pilot-controllable features of the DME receiver include:

*Channel (frequency) selector.* Many DMEs are channeled by an associated VHF radio, or there may be a selector switch so you can select which VHF radio is channeling the DME. For the DMEs that have their own frequency selector, you use the frequency of the associated VOR/DME or VORTAC station.

*On/Off/Volume switch.* The DME identifier will be heard as a Morse code identifier with a tone somewhat higher than that of the associated VOR or LOC. It will be heard once for every three or four times the VOR or LOC identifier is heard. If only one identifier is heard about every 30 seconds, the DME is functional, but the associated VOR or LOC is not.

*Mode switch.* The mode switch selects between distance (DIST) or distance in NMs, groundspeed and time to station. There may also be one or more HOLD functions which permit the DME to stay channeled to the station that was selected before the switch was placed in the hold position. This is useful when you make an ILS approach at a facility that has no colocated DME, but there is a VOR/DME nearby.

*Altitude.* Some DMEs correct for slant-range error.

### Function of DME

A DME is used for determining the distance from a ground DME transmitter. Compared to other VHF/UHF NAVAIDS, a DME is very accurate. The distance information can be used to determine the aircraft position or flying a track that is a constant distance from the station. This is referred to as a **DME arc**.

### DME Arc

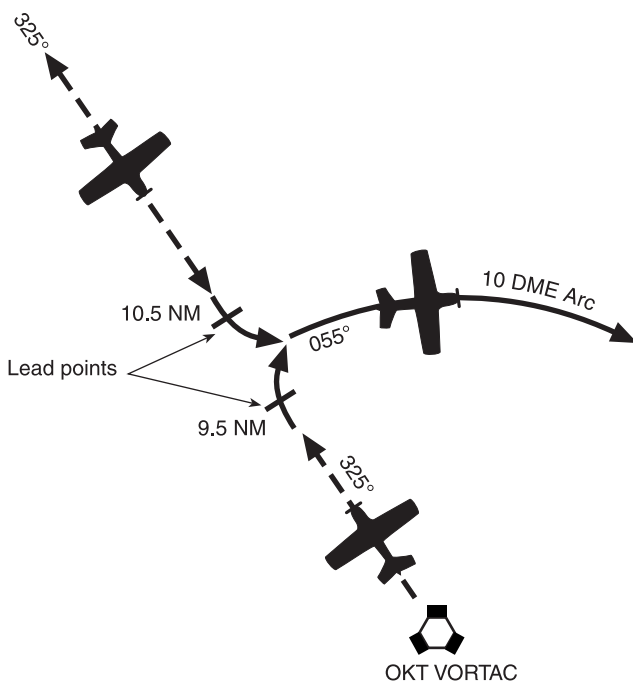
There are many instrument approach procedures (IAPs) that incorporate DME arcs. The procedures and techniques given here for intercepting and maintaining such arcs are applicable to any facility that provides DME information. Such a facility may or may not be colocated with the facility that provides final approach guidance.

**DME arc:** Flying a track that is a constant distance from the station.

As an example of flying a DME arc, refer to figure 7-16 and follow these steps:

1. Track inbound on the OKT 325° radial, frequently checking the DME mileage readout.
2. A .5 NM lead is satisfactory for groundspeeds of 150 knots or less; start the turn to the arc at 10.5 miles. At higher groundspeeds, use a proportionately greater lead.
3. Continue the turn for approximately 90°. The roll-out heading will be 055° in no-wind conditions.
4. During the last part of the intercepting turn, monitor the DME closely. If the arc is being overshoot (more than 1.0 NM), continue through the originally-planned roll-out heading. If the arc is being undershot, roll out of the turn early.

The procedure for intercepting the 10 DME when outbound is basically the same, the lead point being 10 NM minus .5 NM, or 9.5 NM.



**Figure 7-16.** DME arc interception.

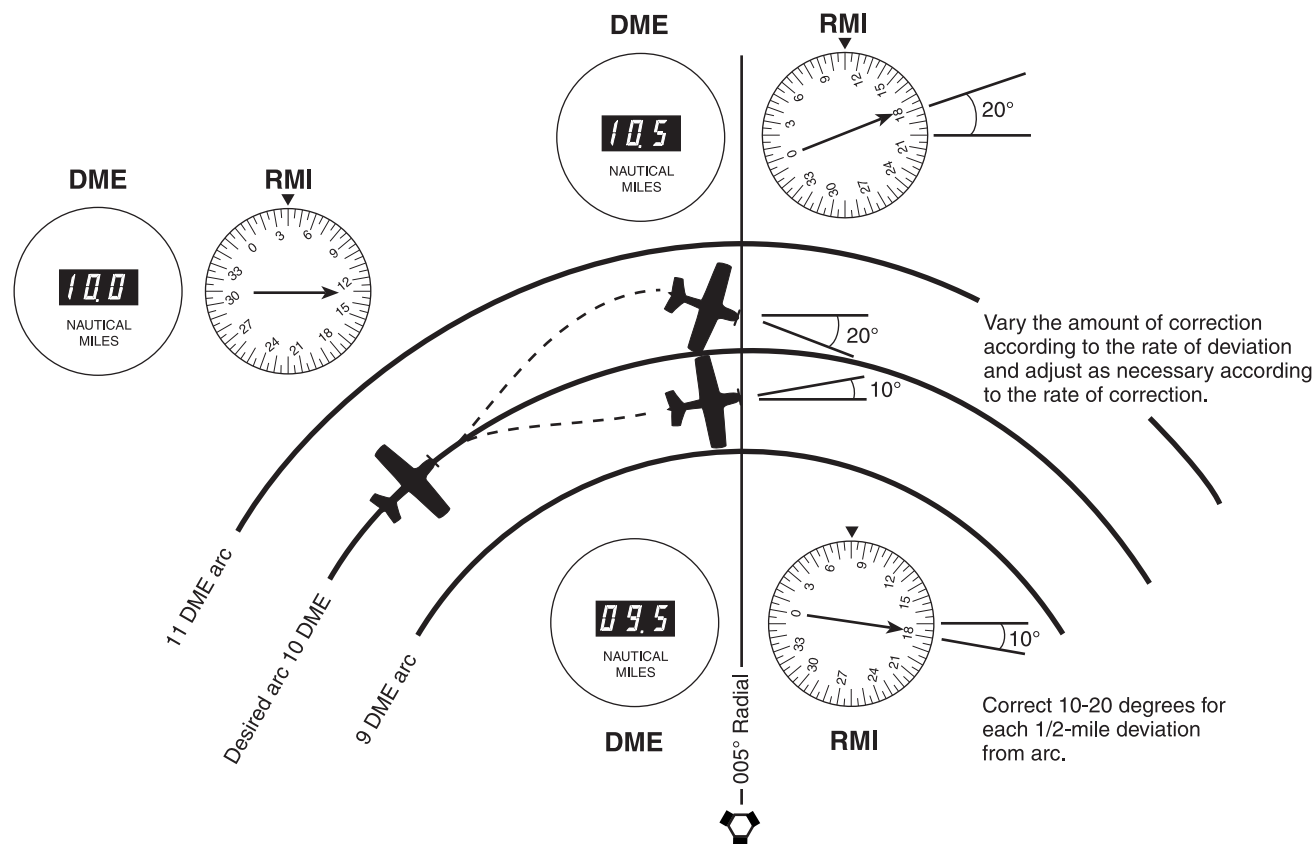
When flying a DME arc with wind, it is important that you keep a continuous mental picture of your position relative to the facility. Since the wind-drift correction angle is constantly changing throughout the arc, wind orientation is important. In some cases, wind can be used in returning to the desired track. High airspeeds require more pilot attention because of the higher rate of deviation and correction.

Maintaining the arc is simplified by keeping slightly inside the curve; thus, the arc is turning toward the aircraft and interception may be accomplished by holding a straight course. If you are outside the curve, the arc is “turning away” and a greater correction is required.

To fly the arc using the VOR CDI, center the CDI needle upon completion of the 90° turn to intercept the arc. The aircraft’s heading will be found very near the left or right side (270° or 90° reference points) of the instrument. The readings at that side location on the instrument will give primary heading information while on the arc. Adjust the aircraft heading to compensate for wind and to correct for distance to maintain the correct arc distance. Re-center the CDI and note the new primary heading indicated whenever the CDI gets 2°–4° from center.

With an RMI, in a no-wind condition, you should theoretically be able to fly an exact circle around the facility by maintaining an RB of 90° or 270°. In actual practice, a series of short legs are flown. To maintain the arc in figure 7-17, proceed as follows:

1. With the RMI bearing pointer on the wingtip reference (90° or 270° position) and the aircraft at the desired DME range, maintain a constant heading and allow the bearing pointer to move 5° to 10° behind the wingtip. This will cause the range to increase slightly.
2. Turn toward the facility to place the bearing pointer 5°–10° ahead of the wingtip reference, then maintain heading until the bearing pointer is again behind the wingtip. Continue this procedure to maintain the approximate arc.
3. If a crosswind is drifting you away from the facility, turn the aircraft until the bearing pointer is ahead of the wingtip reference. If a crosswind is drifting you toward the facility, turn until the bearing pointer is behind the wingtip.
4. As a guide in making range corrections, change the RB 10°–20° for each half-mile deviation from the desired arc. For example, in no-wind conditions, if you are 1/2 to 1 mile outside the arc and the bearing pointer is on the wingtip reference, turn the aircraft 20° toward the facility to return to the arc.



**Figure 7-17.** Using DME and RMI to maintain arc.



## DME Errors

DME/DME fixes (a location based on two DME lines of position from two DME stations) provide a more accurate aircraft location than using a VOR and a DME fix.

DME signals are line-of-sight; the mileage readout is the straight line distance from the aircraft to the DME ground facility and is commonly referred to as slant range distance. Slant range refers to the straight line distance from the aircraft antenna to the ground station, which differs somewhat from the distance from the station to the point on the ground beneath the aircraft. This error is smallest at low altitude and long range. It is greatest when the aircraft is over the ground facility, at which time the DME receiver will display altitude (in NM) above the facility. Slant-range error is negligible if the aircraft is 1 mile or more from the ground facility for each 1,000 feet of altitude above the elevation of the facility.

## Area Navigation (RNAV)

### Description

Area navigation (RNAV) equipment includes VOR/DME, LORAN, GPS, and inertial navigation systems (INS). RNAV equipment is capable of computing the aircraft position, actual track, groundspeed, and then presenting meaningful information to the pilot. This information may be in the form of distance, crosstrack error, and time estimates relative to the selected track or **waypoint**. In addition, the RNAV equipment installations must be approved for use under IFR. The Pilot's Operating Handbook/Airplane Flight Manual (POH/AFM) should always be consulted to determine what equipment is installed, the operations that are approved, and the details of how to use the equipment. Some aircraft may have equipment that allows input from more than one RNAV source thereby providing a very accurate and reliable navigation source.

### VOR/DME RNAV

VOR RNAV is based on information generated by the present VORTAC or VOR/DME systems to create a waypoint using an airborne computer. As shown in figure 7-19, the value of side A is the measured DME distance to the VOR/DME. Side B, the distance from the VOR/DME to the waypoint, angle 1 (VOR radial or the bearing from the VORTAC to the waypoint), are values set in the cockpit control. The bearing

from the VOR/DME to the aircraft, angle 2, is measured by the VOR receiver. The airborne computer continuously compares angles 1 and 2 and determines angle 3 and side C, which is the distance in NMs and magnetic course from the aircraft to the waypoint. This is presented as guidance information on the cockpit display.

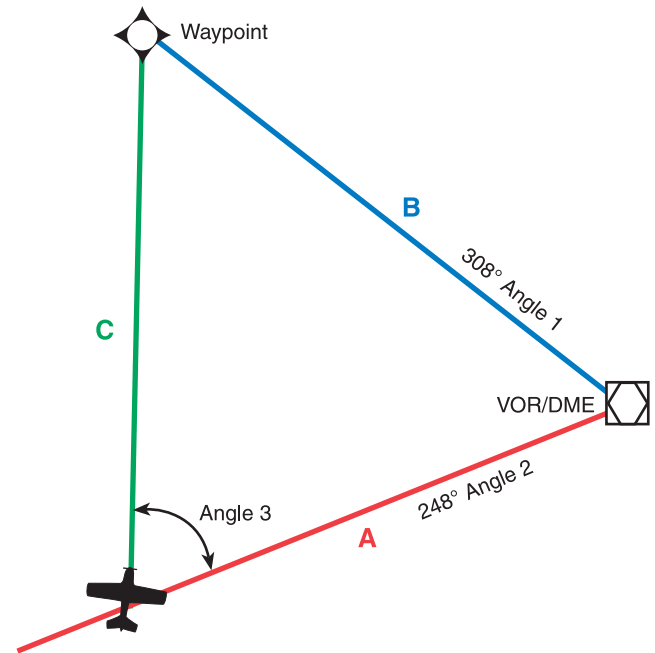


Figure 7-19. RNAV computation.

### VOR/DME RNAV Components

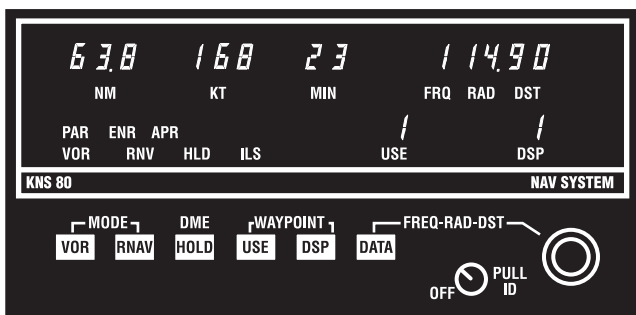
Although RNAV cockpit instrument displays vary among manufacturers, most are connected to the aircraft CDI with a switch or knob to select VOR or RNAV guidance. There is usually a light or indicator to inform the pilot whether VOR or RNAV is selected. [Figure 7-20] The display includes the waypoint, frequency, mode in use, waypoint radial and distance, DME distance, groundspeed, and time to station. Most VOR/DME RNAV systems have the following airborne controls:

1. Off/On/Volume control to select the frequency of the VOR/DME station to be used.

**Waypoint:** A designated geographical location used for route definition or progress-reporting purposes and defined relative to a VOR/DME station or in terms of latitude/longitude coordinates.

2. MODE select switch used to select VOR/DME mode, with:
  - a. Angular course width deviation (standard VOR operation); or
  - b. Linear crosstrack deviation as standard ( $\pm 5$  NM full scale CDI).
3. RNAV mode, with direct to waypoint with linear crosstrack deviation of  $\pm 5$  NM.
4. RNAV/APPR (approach mode) with linear deviation of  $\pm 1.25$  NM as full scale CDI deflection.
5. Waypoint select control. Some units allow the storage of more than one waypoint; this control allows selection of any waypoint in storage.
6. Data input controls. These controls allow user input of waypoint number or ident, VOR or LOC frequency, waypoint radial and distance.

While DME groundspeed readout is accurate only when tracking directly to or from the station in VOR/DME mode, in RNAV mode the DME groundspeed readout is accurate on any track.



**Figure 7-20.** Typical RNAV display.

### Function of VOR/DME RNAV

The advantages of the VOR/DME RNAV system stem from the ability of the airborne computer to locate a waypoint wherever it is convenient, as long as the aircraft is within reception range of both a nearby VOR and DME facility. A series of these waypoints make up an RNAV route. In addition to the published routes, a random RNAV route may be flown under IFR if it is approved by air traffic control (ATC). RNAV DPs and standard terminal arrival routes (STARs) are contained in the DP and STAR booklets.

VOR/DME RNAV approach procedure charts are also available. Note in the VOR/DME RNAV chart excerpt shown in figure 7-21 that the waypoint identification boxes contain the following information: waypoint name, coordinates, frequency, identifier, radial distance (facility to waypoint), and reference facility elevation. The initial approach fix (IAF), final approach fix (FAF), and missed approach point (MAP) are labeled.

To fly either a route or to execute an approach under IFR, the RNAV equipment installed in the aircraft must be approved for the appropriate IFR operations.

In Vertical Nav mode, vertical, as well as horizontal guidance is provided in some installations. A waypoint is selected at a point where the descent begins, and another waypoint is selected where the descent ends. The RNAV equipment computes the rate of descent relative to the groundspeed, and on some installations, displays vertical guidance information on the glide-slope indicator. When using this type of equipment during an instrument approach, the pilot must keep in mind the vertical guidance information provided is *not* part of the nonprecision approach. Published nonprecision approach altitudes must be observed and complied with, unless otherwise directed by ATC.

To fly to a waypoint using RNAV, observe the following procedure [Figure 7-22]:

1. Select the VOR/DME frequency.
2. Select the RNAV mode.
3. Select the radial of the VOR that passes through the waypoint ( $225^\circ$ ).
4. Select the distance from the DME to the waypoint is selected (12 NM).
5. Check and confirm all inputs, and the CDI needle is centered with the TO indicator showing.
6. Maneuver the aircraft to fly the indicated heading  $\pm$  wind correction to keep the CDI needle centered.
7. The CDI needle will indicate distance off course of 1 NM per dot; the DME readout will indicate distance (NM) from the waypoint; the groundspeed will read closing speed (knots) to the waypoint; and the time to station (TTS) will read time to the waypoint.

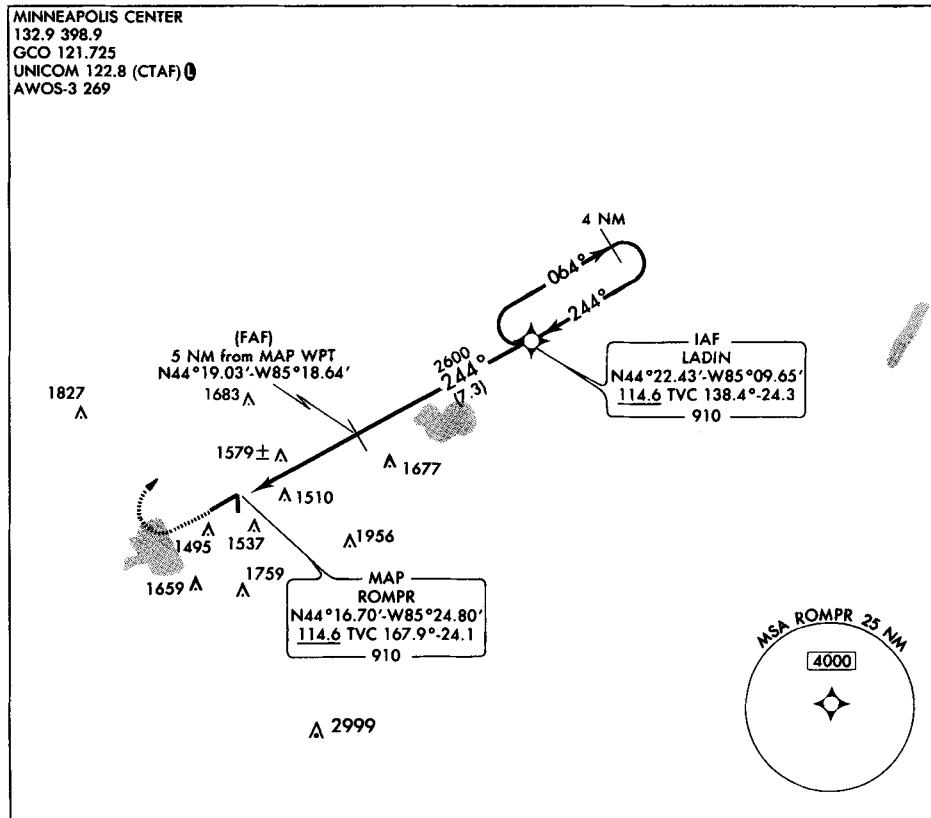


Figure 7-21. VOR/DME RNAV Rwy 25 approach (excerpt).

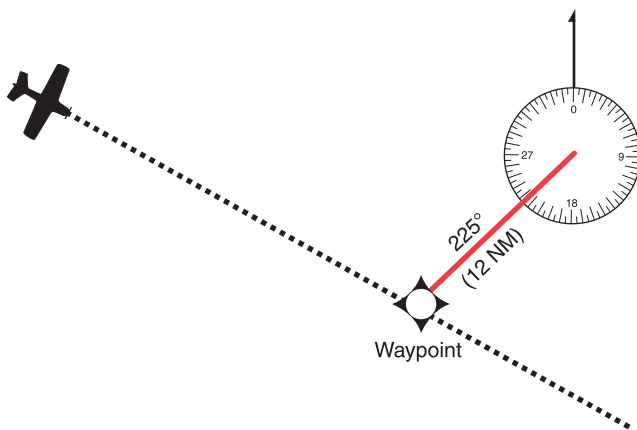


Figure 7-22. Aircraft/VORTAC/waypoint relationship.

### VOR/DME RNAV Errors

The limitation of this system is the reception volume. Published approaches have been tested to ensure this is not a problem. Descents/approaches to airports distant from the VOR/DME facility may not be possible because during the approach, the aircraft may descend below the reception altitude of the facility at that distance.

### Long Range Navigation (LORAN)

LORAN uses a network of land-based transmitters to provide an accurate long range navigation system. The FAA and the United States (U.S.) Coast Guard (USCG) arranged the stations into chains. The signals from these stations are a carefully structured sequence of brief RF pulses centered at 100 kHz. At that frequency, signals travel considerable distances as ground waves, from which accurate navigation information is available. The airborne receiver monitors all of the stations within the selected chain, then measures the arrival time difference (TD) between the signals. All of the points having the same TD from a station pair create a line of position (LOP). The aircraft position is determined at the intersection of two or more LOPs. Then the computer converts the known location to latitude and longitude coordinates. While continually computing latitude/longitude fixes, the computer is able to determine and display:

1. Track over the ground since last computation;
2. Groundspeed by dividing distance covered since last computation by the time since last computation (and averaging several of these);
3. Distance to destination;
4. Destination time of arrival; and
5. Crosstrack error.

The *Aeronautical Information Manual* (AIM) provides a detailed explanation of how LORAN works. LORAN is a very accurate navigation system if adequate signals are received. There are two types of accuracy that must be addressed in any discussion of LORAN accuracy.

*Repeatable accuracy* is the accuracy measured when a user notes the LORAN position, moves away from that location, then uses the LORAN to return to that initial LORAN position. Distance from that initial position is the error. Propagation and terrain errors will be essentially the same as when the first position was taken, so those errors are factored out by using the initial position. Typical repeatable accuracy for LORAN can be as good as 0.01 NM, or 60 feet, if the second position is determined during the day and within a short period of time (a few days).

*Absolute accuracy* refers to the ability to determine present position in space independently, and is most often used by pilots. When the LORAN receiver is turned on and position is determined, absolute accuracy applies. Typical LORAN absolute accuracy will vary from about 0.1 NM to as much as 2.5 NM depending on distance from the station, geometry of the TD LOP crossing angles, terrain and environmental conditions, signal-to-noise ratio (signal strength), and some design choices made by the receiver manufacturer.

### **LORAN Components**

The LORAN receiver incorporates a radio receiver, signal processor, navigation computer, control/display, and antenna. When turned on, the receivers go through an initialization or warm-up period, then inform the user they are ready to be programmed. LORAN receivers vary widely in their appearance, how they are programmed by the user, and how they display navigation information. Therefore, it is necessary to become familiar with the unit, including how to program it, and how to interpret output from it. The LORAN operating manual should be in the aircraft at all times and available to the pilot. IFR-approved LORAN units require that the manual be aboard and that the pilot is familiar with the unit's functions, *before* flight.

### **Function of LORAN**

After initialization, you select for the present location waypoint (the airport), and select **GO TO** in order to determine if the LORAN is functioning properly. Proper operation is indicated by a low distance reading (0 to 0.5 NM). The simplest mode of navigation is referred to as **GO TO**: you select a waypoint from one of the databases and choose the **GO TO** mode. Before use in flight, you should verify that the latitude and longitude of the chosen waypoint is correct by reference to another approved information source. An

updatable LORAN database that supports the appropriate operations (e.g., en route, terminal, and instrument approaches), is required when operating under IFR.

In addition to displaying bearing, distance, time to the waypoint, and track and speed over the ground, the LORAN receiver may have other features such as flight planning (waypoint sequential storage), emergency location of several nearest airports, vertical navigation capabilities, and more.

### **LORAN Errors**

#### *System Errors*

LORAN is subject to interference from many external sources, which can cause distortion of, or interference with LORAN signals. LORAN receiver manufacturers install “notch filters” to reduce or eliminate interference. Proximity to 60 Hz alternating current power lines, static discharge, precipitation static, electrical noise from generators, alternators, strobes, and other onboard electronics may decrease the signal-to-noise ratio to the point where the LORAN receiver's performance is degraded.

Proper installation of the antenna, good electrical bonding, and an effective static discharge system are the minimum requirements for LORAN receiver operation. Most receivers have internal tests that verify the timing alignment of the receiver clock with the LORAN pulse, and measure and display signal-to-noise ratio. A signal will be activated to alert the pilot if any of the parameters for reliable navigation are exceeded on LORAN sets certified for IFR operations.

LORAN is most accurate when the signal travels over sea water during the day, and least accurate when the signal comes over land and large bodies of fresh water or ice at night; furthermore, the accuracy degrades as distance from the station increases. However, LORAN accuracy is generally better than VOR accuracy.

#### *Operational Errors*

Some of the typical pilot-induced errors of LORAN operation are:

1. Use of a nonapproved LORAN receiver for IFR operations. The pilot should check the aircraft's POH/AFM LORAN supplement to be certain the unit's functions are well understood (this supplement must be present in the aircraft for approved IFR operations). There should be a copy of FAA Form 337, Major Repair and Alteration, present in the aircraft's records, showing approval (for use of this model LORAN for IFR operations in this aircraft).

2. Failure to double-check the latitude/longitude values for a waypoint to be used. Whether the waypoint was accessed from the airport, NDB, VOR, or intersection database, the values of latitude and longitude should still be checked against the values in the A/FD or other approved source. If the waypoint data is entered in the user database, its accuracy must be checked before use.
3. Attempting to use LORAN information with degraded signals.

### **Global Positioning System (GPS)**

The Department of Defense (DOD) developed and deployed **GPS** as a space-based positioning, velocity, and time system. The DOD is responsible for the operation the GPS satellite constellation and constantly monitors the satellites to ensure proper operation. The GPS system permits Earth-centered coordinates to be determined and provides aircraft position referenced to the DOD World Geodetic System of 1984 (WGS-84). Satellite navigation systems are unaffected by weather and provide global navigation coverage that fully meets the civil requirements for use as the primary means of navigation in oceanic airspace and certain remote areas. Properly certified GPS equipment may be used as a supplemental means of IFR navigation for domestic en route, terminal operations, and certain IAPs. Navigational values, such as distance and bearing to a waypoint and groundspeed, are computed from the aircraft's current position (latitude and longitude) and the location of the next waypoint. Course guidance is provided as a linear deviation from the desired track of a Great Circle route between defined waypoints.

GPS may not be approved for IFR use in other countries. Prior to its use, pilots should ensure that GPS is authorized by the appropriate countries.

### **GPS Components**

GPS consists of three distinct functional elements: space, control, and user.

The *space* element consists of 24 Navstar satellites. This group of satellites is called a constellation. The satellites are in six orbital planes (with four in each plane) at about 11,000

miles above the Earth. At least five satellites are in view at all times. The GPS constellation broadcasts a pseudo-random code timing signal and data message that the aircraft equipment processes to obtain satellite position and status data. By knowing the precise location of each satellite and precisely matching timing with the atomic clocks on the satellites, the aircraft receiver/processor can accurately measure the time each signal takes to arrive at the receiver and, therefore, determine aircraft position.

The *control* element consists of a network of ground-based GPS monitoring and control stations that ensure the accuracy of satellite positions and their clocks. In its present form, it has five monitoring stations, three ground antennas, and a master control station.

The *user* element consists of antennas and receiver/processors on board the aircraft that provide positioning, velocity, and precise timing to the user. GPS equipment used while operating under IFR must meet the standards set forth in Technical Standard Order (TSO) C-129 (or equivalent); meet the airworthiness installation requirements; be "approved" for that type of IFR operation; and be operated in accordance with the applicable POH/AFM or flight manual supplement.

An updatable GPS database that supports the appropriate operations (e.g., en route, terminal, and instrument approaches), is required when operating under IFR. The aircraft GPS navigation database contains waypoints from the geographic areas where GPS navigation has been approved for IFR operations. The pilot selects the desired waypoints from the database and may add **user-defined waypoints** for the flight.

Equipment approved in accordance with TSO C-115a, visual flight rules (VFR), and hand-held GPS systems do not meet the requirements of TSO C-129 and are not authorized for IFR navigation, instrument approaches, or as a principal instrument flight reference. During IFR operations, these units (TSO C-115a) may only be considered as an aid to situational awareness.

**Global positioning system (GPS):** Navigation system using satellite rather than ground-based transmitters for location information.

**User-defined waypoints:** Waypoint location and other data which may be input by the user; this is the only database that may be altered (edited) by the user.



## Function of GPS

GPS operation is based on the concept of ranging and triangulation from a group of satellites in space which act as precise reference points. The receiver uses data from a minimum of four satellites above the mask angle (the lowest angle above the horizon at which it can use a satellite).

The aircraft GPS receiver measures distance from a satellite using the travel time of a radio signal. Each satellite transmits a specific code, called a course/acquisition (CA) code, which contains information on the satellite's position, the GPS system time, and the health and accuracy of the transmitted data. Knowing the speed at which the signal traveled (approximately 186,000 miles per second) and the exact broadcast time, the distance traveled by the signal can be computed from the arrival time. The distance derived from this method of computing distance is called a pseudo-range because it is not a direct measurement of distance, but a measurement based on time. In addition to knowing the distance to a satellite, a receiver needs to know the satellite's exact position in space; this is known as its ephemeris. Each satellite transmits information about its exact orbital location. The GPS receiver uses this information to precisely establish the position of the satellite.

Using the calculated pseudo-range and position information supplied by the satellite, the GPS receiver/processor mathematically determines its position by triangulation from several satellites. The GPS receiver needs at least four satellites to yield a three-dimensional position (latitude, longitude, and altitude) and time solution. The GPS receiver computes navigational values (e.g., distance and bearing to a waypoint, groundspeed, etc.) by using the aircraft's known latitude/longitude and referencing these to a database built into the receiver.

The GPS receiver verifies the integrity (usability) of the signals received from the GPS constellation through **receiver autonomous integrity monitoring (RAIM)** to determine if a satellite is providing corrupted information. RAIM needs a minimum of five satellites in view, or four satellites and a barometric altimeter **baro-aiding** to detect an integrity anomaly. For receivers capable of doing so, RAIM needs six satellites in view (or five satellites with baro-aiding) to

isolate a corrupt satellite signal and remove it from the navigation solution.

Generally there are two types of RAIM messages. One type indicates that there are not enough satellites available to provide RAIM and another type indicates that the RAIM has detected a potential error that exceeds the limit for the current phase of flight. Without RAIM capability, the pilot has no assurance of the accuracy of the GPS position.

Aircraft using GPS navigation equipment under IFR for domestic en route, terminal operations, and certain IAPs, must be equipped with an approved and operational alternate means of navigation appropriate to the flight. The avionics necessary to receive all of the ground-based facilities appropriate for the route to the destination airport and any required alternate airport must be installed and operational. Ground-based facilities necessary for these routes must also be operational. Active monitoring of alternative navigation equipment is not required if the GPS receiver uses RAIM for integrity monitoring. Active monitoring of an alternate means of navigation *is required* when the RAIM capability of the GPS equipment is lost. In situations where the loss of RAIM capability is predicted to occur, the flight must rely on other approved equipment, delay departure, or cancel the flight.

## GPS Substitution

Aircraft GPS systems, certified for IFR en route and terminal operations, may be used as a substitute for ADF and DME receivers when conducting the following operations within the U.S. NAS.

1. Determining the aircraft position over a DME fix. This includes en route operations at and above 24,000 feet mean sea level (MSL) (FL240) when using GPS for navigation.
2. Flying a DME arc.
3. Navigating TO/FROM an NDB/compass locator.
4. Determining the aircraft position over an NDB/compass locator.
5. Determining the aircraft position over a fix defined by an NDB/compass locator bearing crossing a VOR/LOC course.
6. Holding over an NDB/compass locator.

**Receiver autonomous integrity monitoring (RAIM):** A system used to verify the usability of the received GPS signals, which warns the pilot of malfunctions in the navigation system.

**Baro-aiding:** Entering the current altimeter setting into the GPS receiver to aid RAIM.

Using GPS as a substitute for ADF or DME is subject to the following restrictions:

1. This equipment must be installed in accordance with appropriate airworthiness installation requirements and operated within the provisions of the applicable POH/AFM, or supplement.
2. The required integrity for these operations must be provided by at least en route RAIM, or equivalent.
3. Waypoints, fixes, intersections, and facility locations to be used for these operations must be retrieved from the GPS airborne database. The database must be current. If the required positions cannot be retrieved from the airborne database, the substitution of GPS for ADF and/or DME is not authorized.
4. Procedures must be established for use when RAIM outages are predicted or occur. This may require the flight to rely on other approved equipment or require the aircraft to be equipped with operational NDB and/or DME receivers. Otherwise, the flight must be rerouted, delayed, canceled, or conducted VFR.
5. The CDI must be set to terminal sensitivity (normally 1 or 1-1/4 NM) when tracking GPS course guidance in the terminal area.
6. A non-GPS approach procedure must exist at the alternate airport when one is required. If the non-GPS approaches on which the pilot must rely require DME or ADF, the aircraft must be equipped with DME or ADF avionics as appropriate.
7. Charted requirements for ADF and/or DME can be met using the GPS system, except for use as the principal instrument approach navigation source.

The following provides guidance which is not specific to any particular aircraft GPS system. For specific system guidance, refer to the POH/AFM, or supplement, or contact the system manufacturer.

*To determine the aircraft position over a DME fix:*

1. Verify aircraft GPS system integrity monitoring is functioning properly and indicates satisfactory integrity.
2. If the fix is identified by a five-letter name which is contained in the GPS airborne database, you may select either the named fix as the active GPS waypoint (WP) or the facility establishing the DME fix as the active GPS WP. When using a facility as the active WP, the only acceptable facility is the DME facility which is charted as the one used to establish the DME fix. If this facility is not in your airborne database, you are *not authorized* to use a facility WP for this operation.

3. If the fix is identified by a five-letter name which is not contained in the GPS airborne database, or if the fix is not named, you must select the facility establishing the DME fix or another named DME fix as the active GPS WP.
4. If you select the named fix as your active GPS WP, you are over the fix when the GPS system indicates you are at the active WP.
5. If you select the DME providing facility as the active GPS WP, you are over the fix when the GPS distance from the active WP equals the charted DME value, and you are on the appropriate bearing or course.

*To fly a DME arc:*

1. Verify aircraft GPS system integrity monitoring is functioning properly and indicates satisfactory integrity.
2. Select from the airborne database the facility providing the DME arc as the active GPS WP. The only acceptable facility is the DME facility on which the arc is based. If this facility is not in your airborne database, you are *not authorized* to perform this operation.
3. Maintain position on the arc by reference to the GPS distance instead of a DME readout.

*To navigate TO or FROM an NDB/compass locator:*

1. Verify aircraft GPS system integrity monitoring is functioning properly and indicates satisfactory integrity.
2. Select the NDB/compass locator facility from the airborne database as the active WP. If the chart depicts the compass locator collocated with a fix of the same name, use of that fix as the active WP in place of the compass locator facility *is authorized*.
3. Select and navigate on the appropriate course to or from the active WP.

*To determine the aircraft position over an NDB/compass locator:*

1. Verify aircraft GPS system integrity monitoring is functioning properly and indicates satisfactory integrity.
2. Select the NDB/compass locator facility from the airborne database. When using an NDB/compass locator, that facility must be charted and be in the airborne database. If this facility is not in your airborne database, you are *not authorized* to use a facility WP for this operation.
3. You are over the NDB/compass locator when the GPS system indicates you are at the active WP.

*To determine the aircraft position over a fix made up of an NDB/compass locator bearing crossing a VOR/LOC course:*

1. Verify aircraft GPS system integrity monitoring is functioning properly and indicates satisfactory integrity.
2. A fix made up by a crossing NDB/compass locator bearing will be identified by a five letter fix name. You may select either the named fix or the NDB/compass locator facility providing the crossing bearing to establish the fix as the active GPS WP. When using an NDB/compass locator, that facility must be charted and be in the airborne database. If this facility is not in your airborne database, you are *not authorized* to use a facility WP for this operation.
3. If you select the named fix as your active GPS WP, you are over the fix when the GPS system indicates you are at the WP as you fly the prescribed track from the non-GPS navigation source.
4. If you select the NDB/compass locator facility as the active GPS WP, and are over the fix when the GPS bearing to the active WP is the same as the charted NDB/compass locator bearing for the fix as you fly the prescribed track from the non-GPS navigation source.

*To hold over an NDB/compass locator:*

1. Verify aircraft GPS system integrity monitoring is functioning properly and indicates satisfactory integrity.
2. Select the NDB/compass locator facility from the airborne database as the active WP. When using a facility as the active WP, the only acceptable facility is the NDB/compass locator facility which is charted. If this facility is not in your airborne database, you are not authorized to use a facility WP for this operation.
3. Select nonsequencing (e.g. "HOLD" or "OBS") mode and the appropriate course in accordance with the POH/AFM, or supplement.
4. Hold using the GPS system in accordance with the POH/AFM, or supplement.

### **IFR Flight Using GPS**

Preflight preparations should ensure that the GPS is properly installed and certified with a current database for the type of operation. The GPS operation must be conducted in accordance with the FAA-approved POH/AFM or flight manual supplement. Flightcrew members must be thoroughly familiar with the particular GPS equipment installed in the aircraft, the receiver operation manual, and the POH/AFM or flight manual supplement. Unlike ILS and VOR, the basic operation, receiver presentation to the pilot, and some

capabilities of the equipment can vary greatly. Due to these differences, operation of different brands, or even models of the same brand of GPS receiver under IFR should not be attempted without thorough study of the operation of that particular receiver and installation. Using the equipment in flight under VFR conditions prior to attempting IFR operation will allow further familiarization.

Required preflight preparations should include checking NOTAMs relating to the IFR flight when using GPS as a supplemental method of navigation. GPS satellite outages are issued as GPS NOTAMs both domestically and internationally. Pilots may obtain GPS RAIM availability information for an airport by specifically requesting GPS aeronautical information from an automated flight service station (AFSS) during preflight briefings. GPS RAIM aeronautical information can be obtained for a 3 hour period: the estimated time of arrival (ETA), and 1 hour before to 1 hour after the ETA hour, or a 24 hour timeframe for a specific airport. FAA briefers will provide RAIM information for a period of 1 hour before to 1 hour after the ETA, unless a specific timeframe is requested by the pilot. If flying a published GPS departure, a RAIM prediction should also be requested for the departure airport. Some GPS receivers have the capability to predict RAIM availability. The pilot should also ensure that the required underlying ground-based navigation facilities and related aircraft equipment appropriate to the route of flight, terminal operations, instrument approaches for the destination, and alternate airports/heliports, will be operational for the ETA. If the *required* ground-based facilities and equipment will not be available, the flight should be rerouted, rescheduled, canceled, or conducted under VFR.

Except for programming and retrieving information from the GPS receiver, planning the flight is accomplished in a similar manner to conventional NAVAIDs. Departure waypoint, DP, route, STAR, desired approach, IAF, and destination airport are entered into the GPS receiver according to the manufacturer's instructions. During preflight, additional information may be entered for functions such as ETA, fuel planning, winds aloft, etc.

When the GPS receiver is turned on, it begins an internal process of test and initialization. When the receiver is initialized, the user develops the route by selecting a waypoint or series of waypoints, verifies the data, and selects the active flight plan. This procedure varies widely between the manufacturer's receivers. GPS is a complex system, offering little standardization between receiver models. It is the pilot's responsibility to be familiar with the operation of the equipment in the aircraft.

The GPS receiver provides navigational values such as track, bearing, groundspeed, and distance. These are computed from the aircraft's present latitude and longitude to the location of the next waypoint. Course guidance is provided between waypoints. The pilot has the advantage of knowing the aircraft's actual track over the ground. As long as track and bearing to the waypoint are matched up (by selecting the correct aircraft heading), the aircraft is going directly to the waypoint.

### **GPS Instrument Approaches**

There is a mixture of GPS overlay approaches (approaches with "or GPS" in the title) and GPS stand-alone approaches in the U.S.

Note: GPS instrument approach operations outside the U.S. must be authorized by the appropriate country authority.

While conducting these IAPs, ground-based NAVAIDs are not required to be operational and associated aircraft avionics need not be installed, operational, turned on, or monitored; however, monitoring backup navigation systems is always recommended when available.

Pilots should have a basic understanding of GPS approach procedures and practice GPS IAPs under visual meteorological conditions (VMC) until thoroughly proficient with all aspects of their equipment (receiver and installation) prior to attempting flight in instrument meteorological conditions (IMC).

All IAPs must be retrievable from the current GPS database supplied by the manufacturer or other FAA-approved source. Flying point-to-point on the approach does not assure compliance with the published approach procedure. The proper RAIM sensitivity will not be available and the CDI sensitivity will not automatically change to 0.3 NM. Manually setting CDI sensitivity does not automatically change the RAIM sensitivity on some receivers. Some existing nonprecision approach procedures cannot be coded for use with GPS and will not be available as overlays.

GPS approaches are requested and approved by ATC using the GPS title such as "GPS RWY 24" or "RNAV RWY 35." Using the manufacturer's recommended procedures, the desired approach and the appropriate IAF are selected from the GPS receiver database. Pilots should fly the full approach from an initial approach waypoint (IAWP) or feeder fix unless specifically cleared otherwise. Randomly joining an approach at an intermediate fix does not ensure terrain clearance.

When an approach has been loaded in the flight plan, GPS receivers will give an "arm" annunciation 30 NM straight line distance from the airport/heliport reference point. The approach mode should be "armed" when within 30 NM distance so the receiver will change from en route CDI ( $\pm 5$  NM) and RAIM ( $\pm 2$  NM) sensitivity to  $\pm 1$  NM terminal sensitivity. Where the IAWP is inside this 30 NM point, a CDI sensitivity change will occur once the approach mode is armed and the aircraft is inside 30 NM. Where the IAWP is beyond 30 NM point, CDI sensitivity will not change until the aircraft is within 30 NM point even if the approach is armed earlier. Feeder route obstacle clearance is predicated on the receiver CDI and RAIM being in terminal CDI sensitivity within 30 NM of the airport/heliport reference point; therefore, the receiver should always be armed not later than the 30 NM annunciation.

Pilots should pay particular attention to the exact operation of their GPS receivers for performing holding patterns and in the case of overlay approaches, operations such as procedure turns. These procedures may require manual intervention by the pilot to stop the sequencing of waypoints by the receiver and to resume automatic GPS navigation sequencing once the maneuver is complete. The same waypoint may appear in the route of flight more than once consecutively (e.g., IAWP, final approach waypoint (FAWP), missed approach waypoint (MAHWP) on a procedure turn). Care must be exercised to ensure the receiver is sequenced to the appropriate waypoint for the segment of the procedure being flown, especially if one or more fly-over waypoints are skipped (e.g., FAWP rather than IAWP if the procedure turn is not flown). The pilot may have to sequence past one or more fly-overs of the same waypoint in order to start GPS automatic sequencing at the proper place in the sequence of waypoints.

When receiving vectors to final, most receiver operating manuals suggest placing the receiver in the nonsequencing mode on the FAWP and manually setting the course. This provides an extended final approach course in cases where the aircraft is vectored onto the final approach course outside of any existing segment which is aligned with the runway. Assigned altitudes must be maintained until established on a published segment of the approach. Required altitudes at waypoints outside the FAWP or step-down fixes must be considered. Calculating the distance to the FAWP may be required in order to descend at the proper location.

When within 2 NM of the FAWP with the approach mode armed, the approach mode will switch to active, which results in RAIM and CDI sensitivity changing to the approach mode. Beginning 2 NM prior to the FAWP, the full scale CDI sensitivity will smoothly change from  $\pm 1$  NM, to  $\pm 0.3$  NM at

the FAWP. As sensitivity changes from  $\pm 1$  NM to  $\pm 0.3$  NM approaching the FAWP, and the CDI not centered, the corresponding increase in CDI displacement may give the impression the aircraft is moving further away from the intended course even though it is on an acceptable intercept heading. Referencing the digital track displacement information (crosstrack error), if it is available in the approach mode, may help the pilot remain position oriented in this situation. Being established on the final approach course prior to the beginning of the sensitivity change at 2 NM, will help prevent problems in interpreting the CDI display during **ramp-down**. Requesting or accepting vectors, which will cause the aircraft to intercept the final approach course within 2 NM of the FAWP, is not recommended.

Incorrect inputs into the GPS receiver are especially critical during approaches. In some cases, an incorrect entry can cause the receiver to leave the approach mode. Overriding an automatically selected sensitivity during an approach will cancel the approach mode annunciation. If the approach mode is not armed by 2 NM prior to the FAWP, the approach mode will not become active at 2 NM prior to the FAWP, and the equipment will flag. In these conditions, the RAIM and CDI sensitivity will not ramp down, and the pilot should not descend to minimum descent altitude (MDA), but fly to the MAWP and execute a missed approach. The approach active annunciator and/or the receiver should be checked to ensure the approach mode is active prior to the FAWP.

A GPS missed approach requires pilot action to sequence the receiver past the MAWP to the missed approach portion of the procedure. The pilot must be thoroughly familiar with the activation procedure for the particular GPS receiver installed in the aircraft and must initiate appropriate action after the MAWP. Activating the missed approach prior to the MAWP will cause CDI sensitivity to immediately change to terminal ( $\pm 1$  NM) sensitivity and the receiver will continue to navigate to the MAWP. The receiver will not sequence past the MAWP. Turns should not begin prior to the MAWP. If the missed approach is not activated, the GPS receiver will display an extension of the inbound final approach course and the along track distance (ATD) will increase from the MAWP until it is manually sequenced after crossing the MAWP.

**Ramp-down:** Changing CDI and RAIM from en route to terminal sensitivity, or terminal to approach sensitivity.

Missed approach routings in which the first track is via a course rather than direct to the next waypoint require additional action by the pilot to set the course. Being familiar with all of the inputs required is especially critical during this phase of flight.

If proceeding to an alternate airport, the avionics necessary to receive all of the ground-based facilities appropriate for the route to the alternate airport must be installed and operational. The alternate airport must be served by an approach based on other than GPS or LORAN-C navigation, the aircraft must have operational equipment capable of using that navigation aid, and the required navigation aid must be operational.

### **GPS Errors**

Normally, with 24 satellites in operation, the GPS constellation is expected to be available continuously worldwide. Whenever there is less than 24 operational satellites, at times GPS navigational capability may not be available at certain geographic locations. Loss of signals may also occur in valleys surrounded by high terrain, and any time the aircraft's GPS antenna is "shadowed" by the aircraft's structure (e.g., when the aircraft is banked).

Certain receivers, transceivers, mobile radios, and portable receivers can cause signal interference. Some VHF transmissions may cause "harmonic interference." Pilots can isolate the interference by relocating nearby portable receivers, changing frequencies, or turning off suspected causes of the interference while monitoring the receiver's signal quality data page.

GPS position data can be affected by equipment characteristics and various geometric factors, which typically cause errors of less than 100 feet. Satellite atomic clock inaccuracies, receiver/processors, signals reflected from hard objects (multipath), ionospheric and tropospheric delays, and satellite data transmission errors may cause small position errors or momentary loss of the GPS signal.

**Selective availability (SA)** is a method by which the DOD can, in the interest of national security, create a significant clock and ephemeris error in the satellites. When SA is active, daily predictable horizontal accuracy for any position is

**Selective availability (SA):** A method by which the DOD can, in the interest of national security, create a significant clock and ephemeris error in the satellites, resulting in a navigation error.

within 300 meters or better, 99.99 percent of the time, and within 100 meters or better 95 percent of the time. Daily, predictable vertical accuracy for any position will be within 500 meters or better 99.99 percent of the time, or within 156 meters or better 95 percent of the time. Time is accurate within 900 nanoseconds of universal coordinated time (UTC) 99.99 percent of the time, and within 300 nanoseconds 95 percent of the time. With all of the errors compounded, position data is more accurate than other present day navigational systems.

GPS derived altitude should not be relied upon to determine aircraft altitude since the vertical error can be quite large.

### **Inertial Navigation System (INS)**

**INS** is a system that navigates precisely by dead reckoning, without any input from outside of the aircraft. It is fully self-contained. The INS is initialized by the pilot, who enters into the system its exact location while the aircraft is on the ground before the flight. The INS is also programmed with waypoints along the desired route of flight.

### **INS Components**

INS is considered a stand-alone navigation system, especially when more than one independent unit is onboard. The airborne equipment consists of an accelerometer to measure acceleration—which, when integrated with time, gives velocity—and gyros to measure direction.

Later versions of the INS, called IRS (inertial reference systems) utilize laser gyros and more powerful computers; therefore, the accelerometer mountings no longer need to be kept level and aligned with true north. The computer system can handle the added workload of dealing with the computations necessary to correct for gravitational and directional errors. Consequently, these newer systems are sometimes called strapdown systems, as the accelerometers and gyros are strapped down to the airframe, rather than being mounted on a structure that stays fixed with respect to the horizon and true north.

### **INS Errors**

The principal error associated with INS is degradation of position with time. INS computes position by starting with an accurate position input which is changed continuously as accelerometers and gyros provide speed and direction inputs. Both the accelerometers and the gyros are subject

**Inertial navigation system (INS):** A computer-based navigation system that tracks the movement of an aircraft by signals produced by onboard accelerometers.

to very small errors; as time passes, those errors likely will accumulate.

While the best INS/IRS display errors of 0.1 to 0.4 NM after flights across the North Atlantic of 4 to 6 hours, smaller and less expensive systems are being built that show errors of 1 to 2 NM per hour. This accuracy is more than sufficient for a navigation system that can be combined with and updated by GPS. The synergy of a navigation system consisting of an INS/IRS unit in combination with a GPS resolves the errors and weaknesses of both systems. The GPS is accurate all the time it is working but may be subject to short and periodic outages. The INS is made more accurate because it is continually updated and will continue to function with good accuracy if the GPS has moments of lost signal.

## **Instrument Approach Systems**

### **Description**

Most navigation systems approved for en route and terminal operations under IFR, such as VOR, NDB, and GPS, may also be approved to conduct IAPs. The most common systems in use in the U.S. are the ILS, simplified landing facility (SDF), localizer directional aid (LDA), and microwave landing system (MLS). These systems operate independently of other navigation systems. There are new systems being developed, such as wide area augmentation system (WAAS), local area augmentation system (LAAS), and other systems have been developed for special use.

### **Instrument Landing Systems (ILS)**

The **ILS** system provides both course and altitude guidance to a specific runway. The ILS system is used to execute a precision instrument approach procedure or **precision approach**. [Figure 7-23] The system consists of the following components:

1. A localizer provides horizontal (left/right) guidance along the extended centerline of the runway.
2. A glide slope provides vertical (up/down) guidance toward the runway touchdown point, usually at a 3° slope.
3. Marker beacons provide range information along the approach path.
4. Approach lights assist in the transition from instrument to visual flight.

**Instrument landing system (ILS):** An electronic system that provides both horizontal and vertical guidance to a specific runway, used to execute a precision instrument approach procedure.

**Precision approach:** An instrument approach procedure in which both course and glide-slope information is provided.

**VHF Localizer**

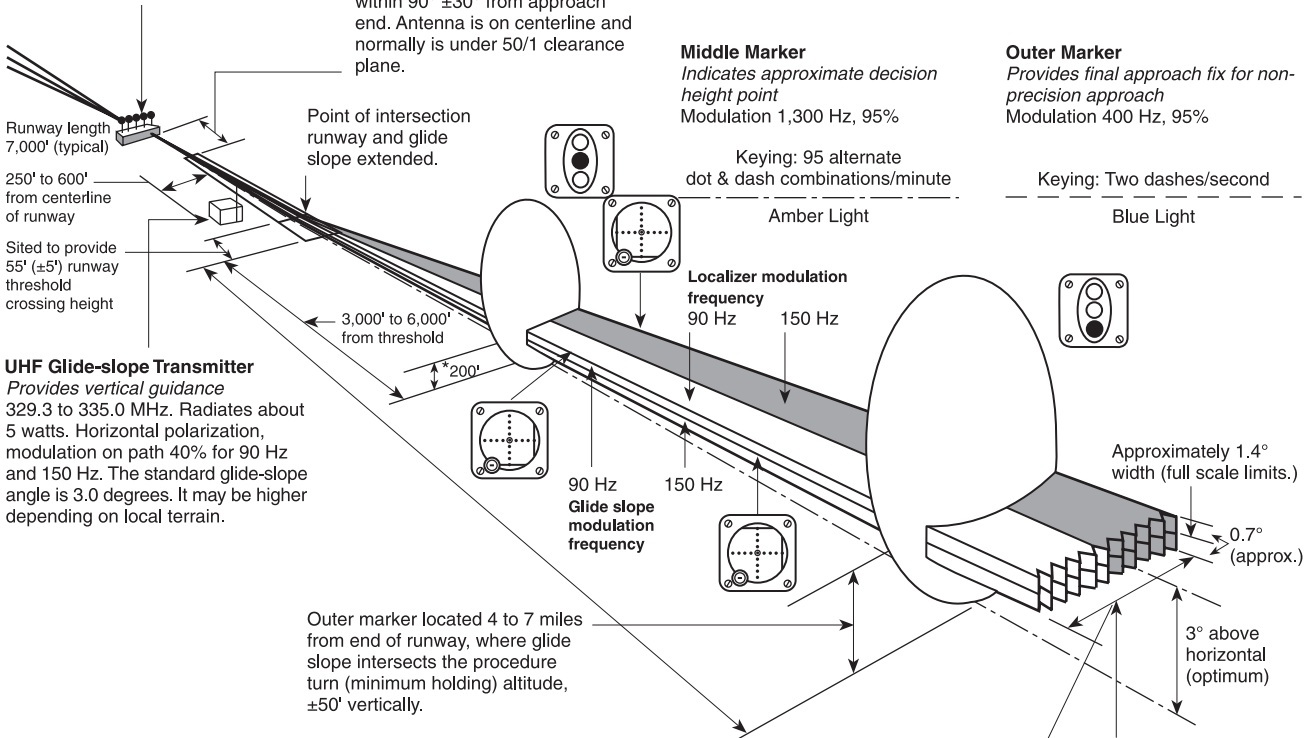
Provides horizontal guidance  
108.10 to 111.95 MHz. Radiates about 100 watts. Horizontal polarization. Modulation frequencies 90 and 150 Hz. Modulation depth on course 20% for each frequency. Code identification (1020 Hz, 5%) and voice communication (modulated 50%) provided on same channel.

ILS approach charts should be consulted to obtain variations of individual systems.

1,000' typical. Localizer transmitter building is offset 250' minimum from center of antenna array and within 90° ±30° from approach end. Antenna is on centerline and normally is under 50/1 clearance plane.



Flag indicates if facility not on the air or receiver malfunctioning



**UHF Glide-slope Transmitter**

Provides vertical guidance  
329.3 to 335.0 MHz. Radiates about 5 watts. Horizontal polarization, modulation on path 40% for 90 Hz and 150 Hz. The standard glide-slope angle is 3.0 degrees. It may be higher depending on local terrain.

**Middle Marker**  
Indicates approximate decision height point  
Modulation 1,300 Hz, 95%

**Outer Marker**  
Provides final approach fix for non-precision approach  
Modulation 400 Hz, 95%

Keying: 95 alternate dot & dash combinations/minute  
Amber Light

Keying: Two dashes/second  
Blue Light

Localizer modulation frequency  
90 Hz 150 Hz

90 Hz  
Glide slope modulation frequency  
150 Hz

Outer marker located 4 to 7 miles from end of runway, where glide slope intersects the procedure turn (minimum holding) altitude, ±50' vertically.

All marker transmitters approximately 2 watts of 75 MHz modulated about 95%.

Course width varies between 3° to 6° tailored to provide 700' at threshold (full scale limits)

**Rate of Descent Chart (feet per minute)**

Speed (Knots)	Angle		
	2.5°	2.75°	3°
90	400	440	475
110	485	535	585
130	575	630	690
150	665	730	795
160	707	778	849

Compass locators, rated at 25 watts output 190 to 535 KHz, are installed at many outer and some middle markers. A 400 Hz or a 1020 Hz tone, modulating the carrier about 95%, is keyed with the first two letters of the ILS identification on the outer locator and the last two letters on the middle locator. At some locations, simultaneous voice transmissions from the control tower are provided, with appropriate reduction in identification percentage.

\*Figures marked with asterisk are typical. Actual figures vary with deviations in distances to markers, glide angles and localizer widths.

**Figure 7-23. Instrument landing systems.**

The following supplementary elements, though not specific components of the system, may be incorporated to increase safety and utility:

1. Compass locators provide transition from en route NAVAIDs to the ILS system; they assist in holding procedures, tracking the localizer course, identifying the marker beacon sites, and providing a FAF for ADF approaches.
2. DME colocated with the glide-slope transmitter provide positive distance-to-touchdown information or DME associated with another nearby facility (VOR or stand-alone), if specified in the approach procedure.

ILS approaches are categorized into three different types of approaches, based on the equipment at the airport and the experience level of the pilot. Category I approaches provide for approach height above touchdown of not less than 200 feet. Category II approaches provide for approach to a height above touchdown of not less than 100 feet. Category III approaches provide lower minimums for approaches without a decision height minimum. While pilots must only be instrument rated and the aircraft be equipped with the appropriate airborne equipment to execute Category I approaches, Category II and III approaches require special certification for the pilots, ground equipment, and airborne equipment.

## ILS Components

### Ground Components

The ILS uses a number of different ground facilities. These facilities may be used as a part of the ILS system, as well as part of another approach. For example, the compass locator may be used with NDB approaches.

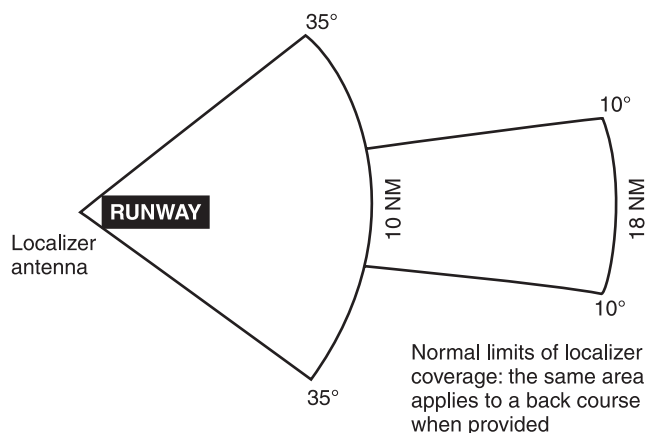
### Localizer

The **localizer (LOC)** ground antenna array is located on the extended centerline of the instrument runway of an airport, remote enough from the opposite (approach) end of the runway to prevent it from being a collision hazard. This unit radiates a field pattern, which develops a course down the centerline of the runway toward the **middle markers (MMs)** and **outer markers (OMs)**, and a similar course along the runway centerline in the opposite direction. These are called the *front* and *back courses*, respectively. The localizer

**Localizer (LOC):** The portion of the ILS that gives left/right guidance information down the centerline of the instrument runway for final approach.

**Middle marker (MM):** VHF marker beacon used in the ILS. When the NDB compass locator is colocated with an MM, it is shown as LMM on instrument approach charts.

provides course guidance, transmitted at 108.1 to 111.95 MHz (odd tenths only), throughout the descent path to the runway threshold from a distance of 18 NM from the antenna to an altitude of 4,500 feet above the elevation of the antenna site. [Figure 7-24]



**Figure 7-24.** Localizer coverage limits.

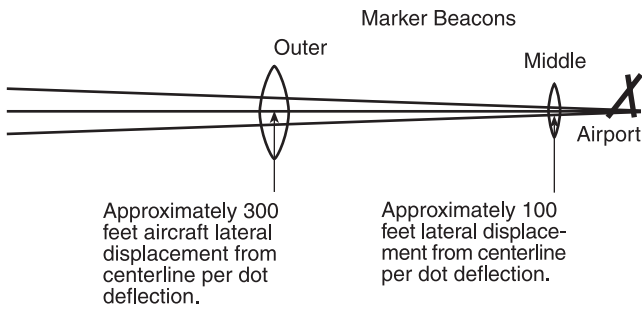
The localizer course width is defined as the angular displacement at any point along the course between a full “fly-left” (CDI needle fully deflected to the left) and a full “fly-right” indication (CDI needle fully deflected to the right.) Each localizer facility is audibly identified by a three-letter designator, transmitted at frequent regular intervals. The ILS identification is preceded by the letter “I” (two dots). For example, the ILS localizer at Springfield, Missouri transmits the identifier ISGF. The localizer includes a voice feature on its frequency for use by the associated ATC facility in issuing approach and landing instructions.

The localizer course is very narrow, normally 5°. This results in high needle sensitivity. With this course width, a full-scale deflection shows when the aircraft is 2.5° to either side of the centerline. This sensitivity permits accurate orientation to the landing runway. With no more than one-quarter scale deflection maintained, the aircraft will be aligned with the runway. [Figure 7-25]

**Outer marker (OM):** VHF marker beacon used in the ILS. When the NDB compass locator is colocated with an OM, it is shown as LOM on instrument approach charts.



## Localizer Course



**Figure 7-25.** Localizer receiver indications and aircraft displacement.

## Glide Slope

**Glide slope (GS)** describes the systems that generate, receive, and indicate the ground facility radiation pattern. The glidepath is the straight, sloped line the aircraft should fly in its descent from where the glide slope intersects the altitude used for approaching the FAF, to the runway touchdown zone. The glide-slope equipment is housed in a building approximately 750 to 1,250 feet down the runway from the approach end of the runway, and between 400 and 600 feet to one side of the centerline.

The course projected by the glide-slope equipment is essentially the same as would be generated by a localizer operating on its side. The glide-slope projection angle is normally adjusted to  $2.5^\circ$  to  $3.5^\circ$  above horizontal, so it intersects the MM at about 200 feet and the OM at about 1,400 feet above the runway elevation. At locations where standard minimum obstruction clearance cannot be obtained with the normal maximum glide-slope angle, the glide-slope equipment is displaced farther from the approach end of the runway if the length of the runway permits; or, the glide-slope angle may be increased up to  $4^\circ$ .

Unlike the localizer, the glide-slope transmitter radiates signals only in the direction of the final approach on the front course. The system provides no vertical guidance for approaches on the back course. The glidepath is normally  $1.4^\circ$  thick. At 10 NM from the point of touchdown, this represents a vertical distance of approximately 1,500 feet, narrowing to a few feet at touchdown.

**Glide slope (GS):** Part of the ILS that projects a radio beam upward at an angle of approximately  $3^\circ$  from the approach end of an instrument runway to provide vertical guidance for final approach.

## Marker Beacons

Two VHF marker beacons, outer and middle, are normally used in the ILS system. A third beacon, the inner, is used where Category II operations are certified. A **marker beacon** may also be installed to indicate the FAF on the ILS back course.

The OM is located on the localizer front course 4 to 7 miles from the airport to indicate a position at which an aircraft, at the appropriate altitude on the localizer course, will intercept the glidepath. The MM is located approximately 3,500 feet from the landing threshold on the centerline of the localizer front course at a position where the glide-slope centerline is about 200 feet above the touchdown zone elevation. The inner marker (IM), where installed, is located on the front course between the MM and the landing threshold. It indicates the point at which an aircraft is at the decision height on the glidepath during a Category II ILS approach. The back-course marker, where installed, indicates the back-course FAF.

## Compass Locator

Compass locators are low-powered NDBs and are received and indicated by the ADF receiver. When used in conjunction with an ILS front course, the compass locator facilities are collocated with the outer and/or MM facilities. The coding identification of the outer locator consists of the *first* two letters of the three-letter identifier of the associated LOC. For example, the outer locator at Dallas/Love Field (DAL) is identified as "DA." The middle locator at DAL is identified by the last two letters "AL."

## Approach Lighting Systems (ALS)

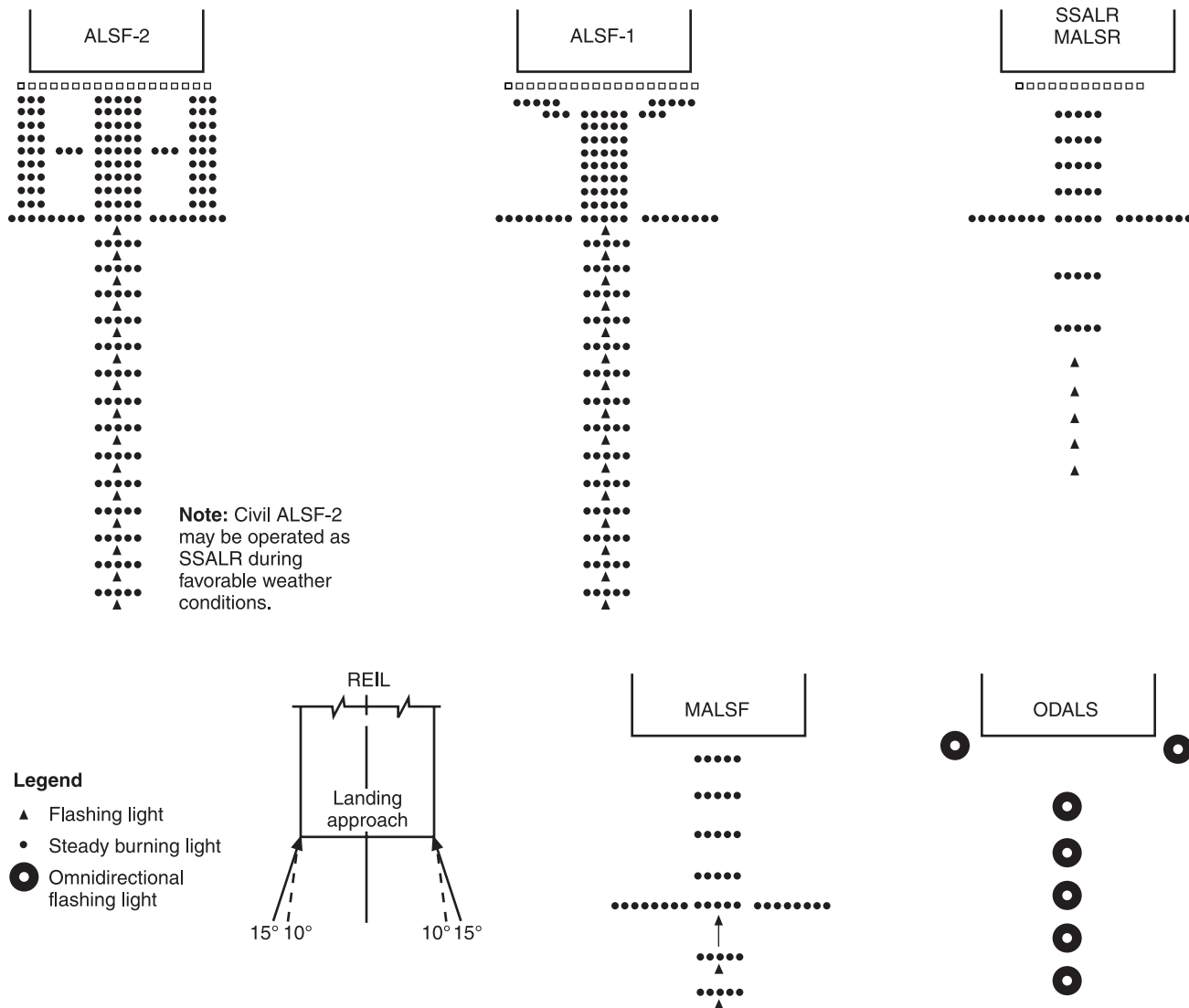
Normal approach and letdown on the ILS is divided into two distinct stages: the instrument approach stage using only radio guidance, and the visual stage, when visual contact with the ground runway environment is necessary for accuracy and safety. The most critical period of an instrument approach, particularly during low ceiling/visibility conditions, is the point at which the pilot must decide whether to land or execute a missed approach. As the runway threshold is approached, the visual glidepath will separate into individual lights. At this point, the approach should be continued by reference to the runway touchdown zone markers. The ALS provides lights that will penetrate the atmosphere far enough from touchdown to give directional, distance, and glidepath information for safe visual transition.

**Marker beacon:** A low-powered transmitter that directs its signal upward in a small, fan-shaped pattern. Used along the flightpath when approaching an airport for landing, marker beacons indicate, both aurally and visually, when the aircraft is directly over the facility.

Visual identification of the ALS by the pilot must be instantaneous, so it is important to know the type of ALS before the approach is started. Check the instrument approach chart and the A/FD for the particular type of lighting facilities at the destination airport before any instrument flight. With reduced visibility, rapid orientation to a strange runway can be difficult, especially during a circling approach to an airport with minimum lighting facilities, or to a large terminal airport located in the midst of distracting city and ground facility

lights. Some of the most common ALS systems are shown in figure 7-26.

A high-intensity flasher system, often referred to as “the rabbit,” is installed at many large airports. The flashers consist of a series of brilliant blue-white bursts of light flashing in sequence along the approach lights, giving the effect of a ball of light traveling towards the runway. Typically, “the rabbit” makes two trips toward the runway per second.



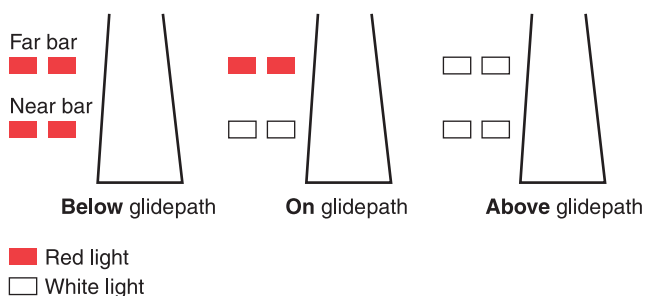
- ALSF**—Approach light system with sequenced flashing lights
- SSALR**—Simplified short approach light system with runway alignment indicator lights
- MALSRL**—Medium intensity approach light system with runway alignment indicator lights
- REIL**—Runway end identification lights
- MALSF**—Medium intensity approach light system with sequenced flashing lights (and runway alignment)
- ODALS**—Omnidirectional approach light system

**Figure 7-26.** Precision and nonprecision ALS configuration.

Runway end identifier lights (REIL) are installed for rapid and positive identification of the approach end of an instrument runway. The system consists of a pair of synchronized flashing lights placed laterally on each side of the runway threshold facing the approach area.

The visual approach slope indicator (VASI) gives visual descent guidance information during the approach to a runway. The standard VASI consists of light bars that project a visual glidepath, which provides safe obstruction clearance within the approach zone. The normal glide-slope angle is 3°; however, the angle may be as high as 4.5° for proper obstacle clearance. On runways served by ILS, the VASI angle normally coincides with the electronic glide-slope angle. Visual left/right course guidance is obtained by alignment with the runway lights. The standard VASI installation consists of either 2-, 3-, 4-, 6-, 12-, or 16-light units arranged in downwind and upwind light bars. Some airports serving long-bodied aircraft have three-bar VASIs which provide two visual glidepaths to the same runway. The first glidepath encountered is the same as provided by the standard VASI. The second glidepath is about 25 percent higher than the first and is designed for the use of pilots of long-bodied aircraft.

The basic principle of VASI is that of color differentiation between red and white. Each light projects a beam having a white segment in the upper part and a red segment in the lower part of the beam. From a position above the glidepath the pilot sees both bars as white. Lowering the aircraft with respect to the glidepath, the color of the upwind bars changes from white to pink to red. When on the proper glidepath, the landing aircraft will overshoot the downwind bars and undershoot the upwind bars. Thus the downwind (closer) bars are seen as white and the upwind bars as red. From a position below the glidepath both light bars are seen as red. Moving up to the glidepath, the color of the downwind bars changes from red to pink to white. When below the glidepath, as indicated by a distinct all-red signal, a safe obstruction clearance might not exist. A standard two-bar VASI is illustrated in figure 7-27.



**Figure 7-27.** Standard 2-bar VASI.

### ILS Airborne Components

Airborne equipment for the ILS system includes receivers for the localizer, glide slope, marker beacons, ADF, DME, and the respective indicator instruments.

The typical VOR receiver is also a localizer receiver with common tuning and indicating equipment. Some receivers have separate function selector switches, but most switch between VOR and LOC automatically by sensing if odd tenths between 108 and 111.95 MHz have been selected. Otherwise, tuning of VOR and localizer frequencies is accomplished with the same knobs and switches, and the CDI indicates “on course” as it does on a VOR radial.

Though some glide-slope receivers are tuned separately, in a typical installation the glide slope is tuned automatically to the proper frequency when the localizer is tuned. Each of the 40 localizer channels in the 108.10 to 111.95 MHz band is paired with a corresponding glide-slope frequency.

When the localizer indicator also includes a glide-slope needle, the instrument is often called a cross-pointer indicator. The crossed horizontal (glide slope) and vertical (localizer) needles are free to move through standard five-dot deflections to indicate position on the localizer course and glidepath.

When the aircraft is on the glidepath, the needle is horizontal, overlying the reference dots. Since the glidepath is much narrower than the localizer course (approximately 1.4° from full up to full down deflection), the needle is very sensitive to displacement of the aircraft from on-path alignment. With the proper rate of descent established upon glide-slope interception, very small corrections keep the aircraft aligned.

The localizer and glide-slope warning flags disappear from view on the indicator when sufficient voltage is received to actuate the needles. The flags show when an unstable signal or receiver malfunction occurs.

The OM is identified by a low-pitched tone, continuous dashes at the rate of two per second, and a purple/blue marker beacon light. The MM is identified by an intermediate tone, alternate dots and dashes at the rate of 95 dot/dash combinations per minute, and an amber marker beacon light. The IM, where installed, is identified by a high-pitched tone, continuous dots at the rate of six per second, and a white marker beacon light. The back-course marker (BCM), where installed, is identified by a high-pitched tone with two dots at a rate of 72 to 75 two-dot combinations per minute, and a white marker beacon light. Marker beacon receiver sensitivity

is selectable as high or low on many units. The low-sensitivity position gives the sharpest indication of position and should be used during an approach. The high-sensitivity position provides an earlier warning that the aircraft is approaching the marker beacon site.

### ILS Function

The localizer needle indicates, by deflection, whether the aircraft is right or left of the localizer centerline, regardless of the position or heading of the aircraft. Rotating the OBS has no effect on the operation of the localizer needle, although it is useful to rotate the OBS to put the LOC inbound course under the course index. When inbound on the front course, or outbound on the back course, the course indication remains **directional**. (See figure 7-28, aircraft C, D, and E.)

Unless the aircraft has reverse sensing capability and it is in use, when flying inbound on the back course or outbound on the front course, heading corrections to on-course are made opposite the needle deflection. This is commonly described as “flying away from the needle.” (See figure 7-28, aircraft A and B.) Back course signals should not be used for an approach unless a back course approach procedure is published for that particular runway and the approach is authorized by ATC.

Once you have reached the localizer centerline, maintain the inbound heading until the CDI moves off center. Drift corrections should be small and reduced proportionately as the course narrows. By the time you reach the OM, your drift correction should be established accurately enough on a well-executed approach to permit completion of the approach, with heading corrections no greater than 2°.

The heaviest demand on pilot technique occurs during descent from the OM to the MM, when you maintain the localizer course, adjust pitch attitude to maintain the proper rate of descent, and adjust power to maintain proper airspeed. Simultaneously, the altimeter must be checked and preparation made for visual transition to land or for a missed approach. You can appreciate the need for accurate instrument interpretation and aircraft control within the ILS as a whole, when you notice the relationship between CDI and glidepath needle indications, and aircraft displacement from the localizer and glidepath centerlines.

**Directional:** Heading corrections toward on-course are made in the same direction as needle deflection.

ILS inbound course is 180°:

- A. As you pass over the FAF with a left turn to north, radio tuned to ILS and identified, course needle is “reverse sensing”; correct to left to center the course needle.
- B. As you begin procedure turn, course needle shows divergence from course centerline increasing.
- C. Procedure turn inbound, course needle no longer is reverse sensing. Start turn to final approach course when needle “comes alive” (needle moves away from side).
- D. Maintain course with the needle centered.
- E. As you fly a missed approach out the back course, the needle indicates “fly left” to get back on course centerline.

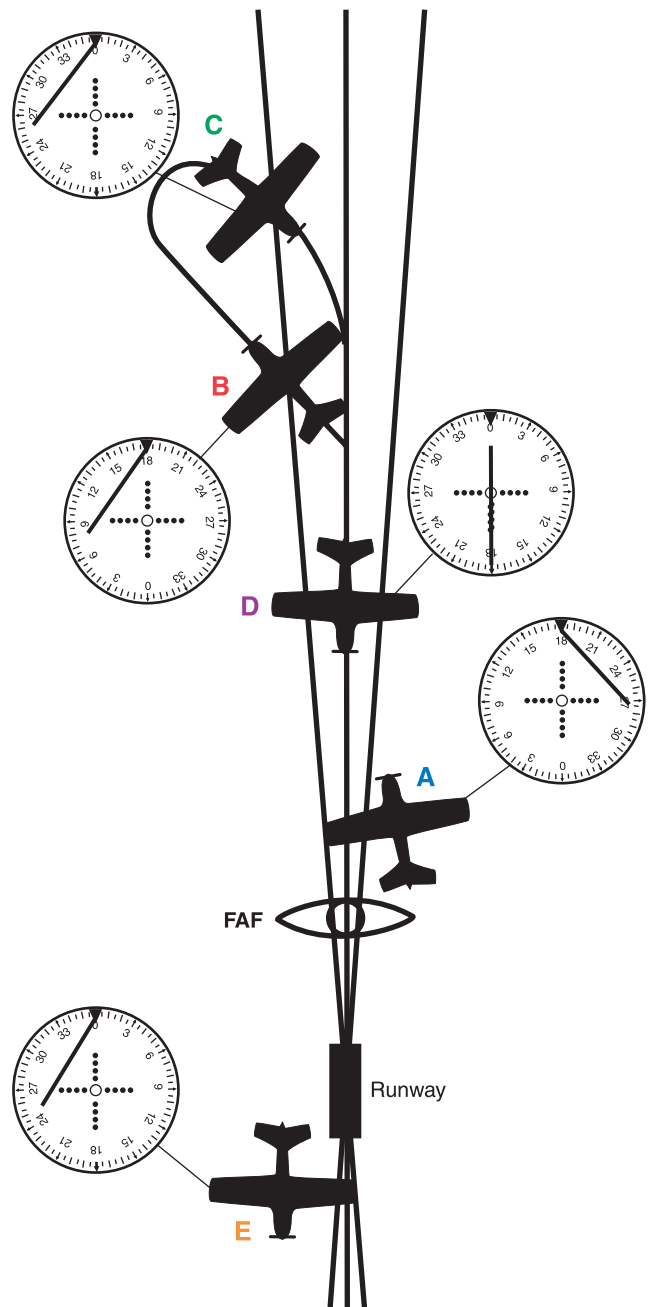
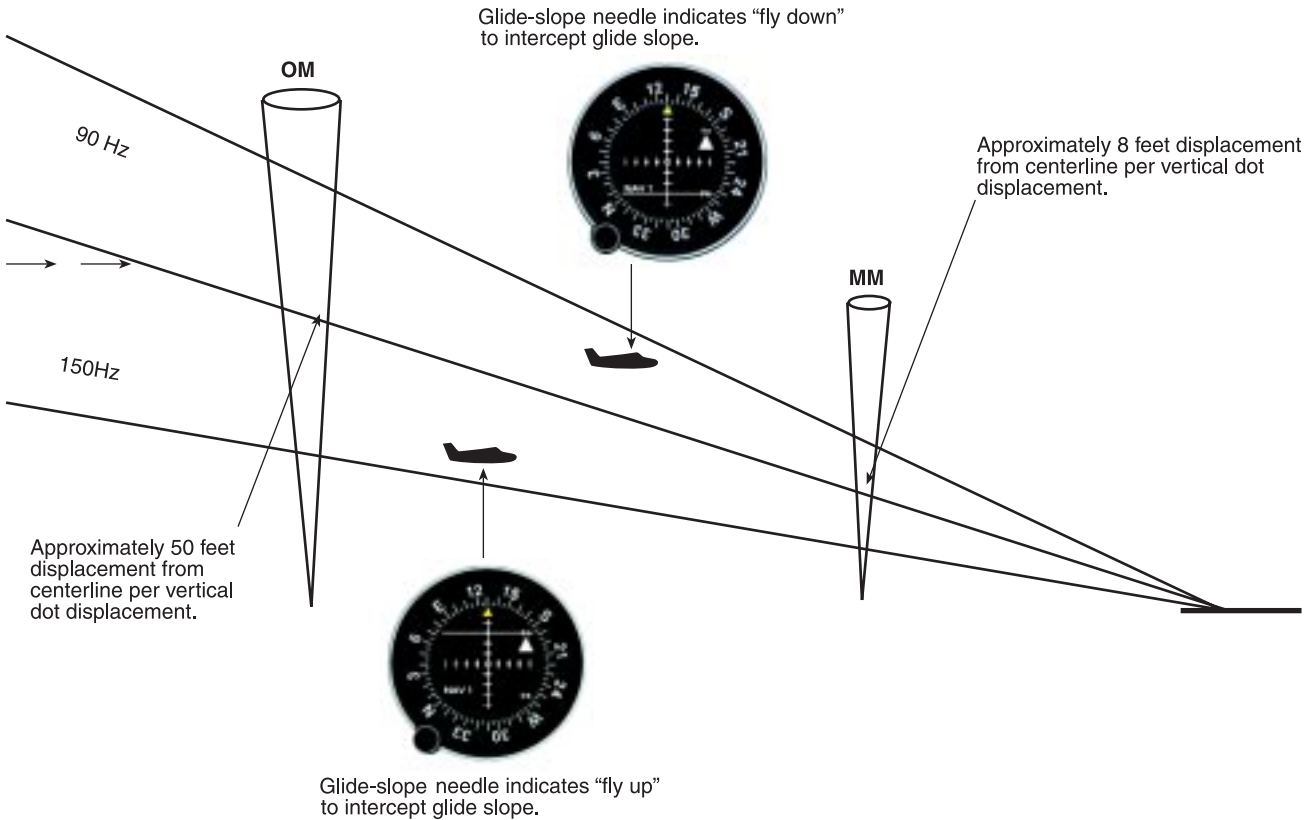


Figure 7-28. Localizer course indications.

## Glide Slope



**Figure 7-29.** *Glide-slope receiver indications and aircraft displacement.*

Deflection of the glide-slope needle indicates the position of the aircraft with respect to the glidepath. When the aircraft is above the glidepath, the needle is deflected downward. When the aircraft is below the glidepath, the needle is deflected upward. [Figure 7-29]

### ILS Errors

The ILS and its components are subject to certain errors, which are listed below.

Localizer and glide-slope signals are subject to the same type of bounce from hard objects as space waves.

1. Reflection. Surface vehicles and even other aircraft flying below 5,000 feet above ground level (AGL) may disturb the signal for aircraft on the approach.
2. False courses. In addition to the desired course, glide-slope facilities inherently produce additional courses at higher vertical angles. The angle of the lowest of these false courses will occur at approximately  $9^{\circ}$ – $12^{\circ}$ . An aircraft flying the LOC/glide-slope course at a constant altitude would observe gyrations of both the glide-slope needle and glide-slope warning flag as the aircraft passed

through the various false courses. Getting established on one of these false courses will result in either confusion (reversed glide-slope needle indications), or result in the need for a very high descent rate. However, if the approach is conducted at the altitudes specified on the appropriate approach chart, these false courses will not be encountered.

### Marker Beacons

The very low power and directional antenna of the marker beacon transmitter ensures that the signal will not be received any distance from the transmitter site. Problems with signal reception are usually caused by the airborne receiver not being turned on, or by incorrect receiver sensitivity.

Some marker beacon receivers, to decrease weight and cost, are designed without their own power supply. These units utilize a power source from another radio in the avionics stack, often the ADF. In some aircraft, this requires the ADF to be turned on in order for the marker beacon receiver to function, yet no warning placard is required. Another source of trouble may be the "High/Low/Off" three-position switch, which both activates the receiver and selects receiver

sensitivity. Usually, the “test” feature only tests to see if the light bulbs in the marker beacon lights are working. Therefore, in some installations, there is no functional way for the pilot to ascertain the marker beacon receiver is actually on except to fly over a marker beacon transmitter, and see if a signal is received and indicated (e.g., audibly and marker beacon lights).

### *Operational Errors*

1. Failure to understand the fundamentals of ILS ground equipment, particularly the differences in course dimensions. Since the VOR receiver is used on the localizer course, the assumption is sometimes made that interception and tracking techniques are identical when tracking localizer courses and VOR radials. Remember that the CDI sensing is sharper and faster on the localizer course.
2. Disorientation during transition to the ILS due to poor planning and reliance on one receiver instead of on all available airborne equipment. Use all the assistance you have available; the single receiver you may be relying on may fail at a busy time.
3. Disorientation on the localizer course, due to the first error noted above.
4. Incorrect localizer interception angles. A large interception angle usually results in overshooting, and possible disorientation. When intercepting, if possible, turn to the localizer course heading immediately upon the first indication of needle movement. An ADF receiver is an excellent aid to orient you during an ILS approach if there is a locator or NDB on the inbound course.
5. Chasing the CDI and glidepath needles, especially when you have not sufficiently studied the approach *before* the flight.

### **Simplified Directional Facility (SDF)**

The SDF provides a final approach course similar to the ILS localizer. The SDF course may or may not be aligned with the runway and the course may be wider than a standard ILS localizer, resulting in less precision. Usable off-course indications are limited to 35° either side of the course centerline. Instrument indications in the area between 35° and 90° from the course centerline are not controlled and should be disregarded.

The SDF antenna may be offset from the runway centerline. Because of this, the angle of convergence between the final approach course and the runway bearing should be determined by reference to the instrument approach chart. This angle is usually not more than 3°. You should note this angle since the approach course originates at the antenna

site, and an approach continued beyond the runway threshold would lead the aircraft to the SDF offset position rather than along the runway centerline.

The course width of the SDF signal emitted from the transmitter is fixed at either 6° or 12°, as necessary, to provide maximum flyability and optimum approach course quality. A three-letter identifier is transmitted in code on the SDF frequency; there is no letter “I” (two dots) transmitted before the station identifier, as there is with the LOC. For example, the identifier for Lebanon, Missouri, SDF is LBO.

### **Localizer Type Directional Aid (LDA)**

The LDA is of comparable utility and accuracy to a localizer but is not part of a complete ILS. The LDA course width is between 3° and 6° and thus provides a more precise approach course than an SDF installation. Some LDAs are equipped with a glide slope. The LDA course is not aligned with the runway, but straight-in minimums may be published where the angle between the runway centerline and the LDA course does not exceed 30°. If this angle exceeds 30°, only circling minimums are published. The identifier is three letters preceded by “I” transmitted in code on the LDA frequency. For example, the identifier for Van Nuys, California, LDA is I-BUR.

### **Microwave Landing System (MLS)**

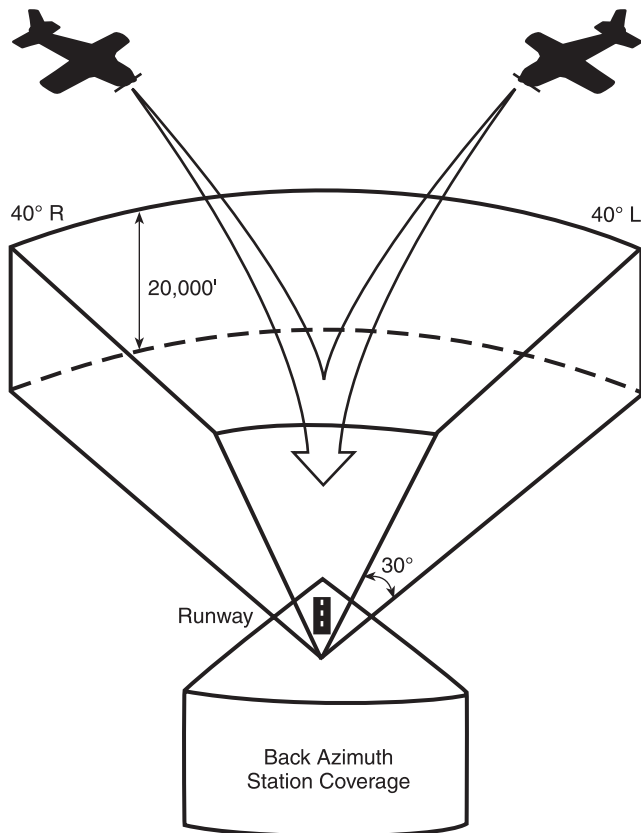
The Microwave Landing System (MLS) provides precision approach navigation guidance. Transmitting in the frequency range of 5031 to 5091 MHz, it provides azimuth (left/right) and elevation (glide slope) information, displayed either on conventional CDIs or with multifunction cockpit displays. Range information is also provided.

MLS requires separate airborne equipment to receive and process the signals from what is normally installed in general aviation aircraft today. It has data communications capability, and can provide audible information about the condition of the transmitting system and other pertinent data such as weather, runway status, etc. The MLS transmits an audible identifier consisting of four letters beginning with the letter M, in Morse code at a rate of at least six per minute. The MLS system monitors itself and transmits ground-to-air data messages about the system’s operational condition. During periods of routine or emergency maintenance, the coded identification is missing from the transmissions.

The MLS is made up of an approach azimuth station (transmitter/antenna) with data transmission capability, an elevation station, a range station, and sometimes a back azimuth station.

### Approach Azimuth Station

The approach azimuth station, unlike ILS, is able to provide approach guidance along any path within its  $\pm 40^\circ$  (to runway alignment) range. [Figure 7-30] Therefore, curved and segmented approaches are possible. This facility also provides the data communications capability of the system. This station is normally located about 1,000 feet beyond the stop end of the runway, but beyond this limitation there is considerable latitude in actual station location. A back azimuth station may be operating in conjunction with the approach azimuth station. If so, lateral guidance is available for missed approach and departure navigation.



**Figure 7-30.** MLS coverage volumes, 3-D representation.

### Elevation Guidance Station

Like the approach azimuth station, the elevation guidance station has considerably more capability than the ILS glide-slope system. Approach glidepath angles are selectable over a wide range up to at least  $15^\circ$ , with coverage to a maximum of  $30^\circ$ . This provides considerable flexibility for developing multipath approaches.

### Range Guidance Station

The range guidance station transmits both normal and precision DME (DME/P) signals that function the same as normal DME (DME/N), with some technical and accuracy differences. Accuracy is improved to be consistent with the accuracy provided by the MLS azimuth and elevation stations.

## Flight Management Systems (FMS)

### Description

The Flight Management Systems (FMS) is not a navigation system in itself. Rather, it is a system that automates the tasks of managing the onboard navigation systems. FMS may perform other onboard management tasks, but this discussion is limited to its navigation function.

FMS is an interface between flightcrews and flight-deck systems. FMS can be thought of as a computer with a large database of airport and NAVAID locations and associated data, aircraft performance data, airways, intersections, DPs, and STARs. FMS also has the ability to accept and store numerous user-defined waypoints, flight routes consisting of departures, waypoints, arrivals, approaches, alternates, etc. FMS can quickly define a desired route from the aircraft's current position to any point in the world, perform flight plan computations, and display the total picture of the flight route to the crew.

FMS also has the capability of controlling (selecting) VOR, DME, and LOC NAVAIDs, and then receiving navigational data from them. INS, LORAN, and GPS navigational data may also be accepted by the FMS computer. The FMS may act as the input/output device for the onboard navigation systems, so that it becomes the "go-between" for the crew and the navigation systems.

### Function of FMS

At startup, the crew programs the aircraft location, departure runway, DP (if applicable), waypoints defining the route, approach procedure, approach to be used, and routing to alternate. This may be entered manually, be in the form of a stored flight plan, or be a flight plan developed in another computer and transferred by disk or electronically to the FMS computer. The crew enters this basic information in the control/display unit (CDU). [Figure 7-31]



**Figure 7-31.** FMS CDU in flight plan mode.

Once airborne, the FMS computer channels the appropriate NAVAIDs and takes radial/distance information, or channels two NAVAIDs, taking the more accurate distance information. FMS then indicates position, track, desired heading, groundspeed and position relative to desired track. Position information from the FMS updates the INS. In more sophisticated aircraft, the FMS provides inputs to the HSI, RMI, glass cockpit navigation displays, **head-up display (HUD)**, autopilot, and autothrottle systems.

### Head-up Display (HUD)

#### Description

The HUD is a display system that provides a projection of navigation and air data (airspeed in relation to approach reference speed, altitude, left/right and up/down glide slope) on a transparent screen between the pilot and the windshield.

**Head-up display (HUD):** A special type of flight viewing screen that allows the pilot to watch the flight instruments while looking through the windshield of the aircraft for other traffic, the approach lights, or the runway.

Other information may be displayed, including a runway target in relation to the nose of the aircraft. This allows the pilot to see the information necessary to make the approach while also being able to see out the windshield, which diminishes the need to shift between looking at the panel to looking outside. Virtually any information desired can be displayed on the HUD if it is available in the aircraft's flight computer, and if the display is user-definable.

### Radar Navigation (Ground Based)

#### Description

Radar works by transmitting a pulse of RF energy in a specific direction. The return of the echo or bounce of that pulse from a target is precisely timed. From this, the distance traveled by the pulse and its echo is determined and displayed on a radar screen in such a manner that the distance and bearing



to this target can be instantly determined. The radar transmitter must be capable of delivering extremely high power levels toward the airspace under surveillance, and the associated radar receiver must be able to detect extremely small signal levels of the returning echoes.

The radar display system provides the controller with a map-like presentation upon which appear all the radar echoes of aircraft within detection range of the radar facility. By means of electronically-generated range marks and azimuth-indicating devices, the controller can locate each radar target with respect to the radar facility, or can locate one radar target with respect to another.

Another device, a video-mapping unit, generates an actual airway or airport map and presents it on the radar display equipment. Using the video-mapping feature, the air traffic controller not only can view the aircraft targets, but will see these targets in relation to runways, navigation aids, and hazardous ground obstructions in the area. Therefore, radar becomes a navigational aid, as well as the most significant means of traffic separation.

In a display presenting perhaps a dozen or more targets, a primary surveillance radar system cannot identify one specific radar target, and it may have difficulty “seeing” a small target at considerable distance—especially if there is a rain shower or thunderstorm between the radar site and the aircraft. This problem is solved with the Air Traffic Control Radar Beacon System (ATCRBS), sometimes called secondary surveillance radar (SSR), which utilizes a transponder in the aircraft. The ground equipment is an interrogating unit, with the beacon antenna mounted so it rotates with the surveillance antenna. The interrogating unit transmits a coded pulse sequence that actuates the aircraft transponder. The transponder answers the coded sequence by transmitting a preselected coded sequence back to the ground equipment, providing a strong return signal and positive aircraft identification, as well as other special data such as the aircraft’s altitude.

### Functions of Radar Navigation

The radar systems used by ATC are **air route surveillance radar (ARSR)**, **airport surveillance radar (ASR)**, **precision approach radar (PAR)** and **airport surface detection equipment (ASDE)**. Surveillance radars scan through 360°

of azimuth and present target information on a radar display located in a tower or center. This information is used independently or in conjunction with other navigational aids in the control of air traffic.

ARSR is a long-range radar system designed primarily to cover large areas and provide a display of aircraft while en route between terminal areas. The ARSR enables air route traffic control center (ARTCC) controllers to provide radar service when the aircraft are within the ARSR coverage. In some instances, ARSR may enable ARTCC to provide terminal radar services similar to but usually more limited than those provided by a radar approach control.

ASR is designed to provide relatively short-range coverage in the general vicinity of an airport and to serve as an expeditious means of handling terminal area traffic through observation of precise aircraft locations on a radarscope. Nonprecision instrument approaches are available at airports that have an approved surveillance radar approach procedure. ASR provides radar vectors to the final approach course, and then azimuth information to the pilot during the approach. Along with range (distance) from the runway, the pilot is advised of MDA, when to begin descent, and when at the MDA. If requested, recommended altitudes will be furnished each mile while on final.

PAR is designed to be used as a landing aid displaying range, azimuth, and elevation information rather than an aid for sequencing and spacing aircraft. PAR equipment may be used as a primary landing aid, or it may be used to monitor other types of approaches. Two antennas are used in the PAR array, one scanning a vertical plane, and the other scanning horizontally. Since the range is limited to 10 miles, azimuth to 20°, and elevation to 7°, only the final approach area is covered. The controller’s scope is divided into two parts. The upper half presents altitude and distance information, and the lower half presents azimuth and distance.

The PAR is one in which a controller provides highly accurate navigational guidance in azimuth and elevation to a pilot. Pilots are given headings to fly, to direct them to, and keep their aircraft aligned with the extended centerline of the landing runway. They are told to anticipate glidepath interception approximately 10 to 30 seconds before it occurs

**Air route surveillance radar (ARSR):** Air route traffic control center (ARTCC) radar used primarily to detect and display an aircraft’s position while en route between terminal areas.

**Airport surveillance radar (ASR):** Approach control radar used to detect and display an aircraft’s position in the terminal area.

**Precision approach radar (PAR):** A specific type and installation of radar, usually found at military or joint-use airfields. It uses two radar antennas, one for left/right information and one for glidepath information to provide a precision approach.

**Airport surface detection equipment (ASDE):** Radar equipment specifically designed to detect all principle features and traffic on the surface of an airport, presenting the entire image on the control tower console.

and when to start descent. The published decision height (DH) will be given only if the pilot requests it. If the aircraft is observed to deviate above or below the glidepath, the pilot is given the relative amount of deviation by use of terms “slightly” or “well” and is expected to adjust the aircraft’s rate of descent/ascent to return to the glidepath. Trend information is also issued with respect to the elevation of the aircraft and may be modified by the terms “rapidly” and “slowly”; e.g., “well above glidepath, coming down rapidly.” Range from touchdown is given at least once each mile. If an aircraft is observed by the controller to proceed outside of specified safety zone limits in azimuth and/or elevation and continue to operate outside these prescribed limits, the pilot will be directed to execute a missed approach or to fly a specified course unless the pilot has the runway environment (runway, approach lights, etc.) in sight. Navigational guidance in azimuth and elevation is provided to the pilot until the aircraft reaches the published decision altitude (DA)/DH. Advisory course and glidepath information is furnished by the controller until the aircraft passes over the landing threshold, at which point the pilot is advised of any deviation from the runway centerline. Radar service is automatically terminated upon completion of the approach.

#### *Airport Surface Detection Equipment*

Radar equipment is specifically designed to detect all principal features on the surface of an airport, including aircraft and vehicular traffic, and to present the entire image on a radar indicator console in the control tower. It is used to augment visual observation by tower personnel of aircraft and/or vehicular movements on runways and taxiways.

#### **Radar Limitations**

1. It is very important for the aviation community to recognize the fact that there are limitations to radar service and that ATC controllers may not always be able to issue traffic advisories concerning aircraft which are not under ATC control and cannot be seen on radar.
2. The characteristics of radio waves are such that they normally travel in a continuous straight line unless they are “bent” by abnormal atmospheric phenomena such as temperature inversions; reflected or attenuated by dense objects such as heavy clouds, precipitation, ground obstacles, mountains, etc.; or screened by high terrain features.
3. Primary radar energy that strikes dense objects will be reflected and displayed on the operator’s scope thereby blocking out aircraft at the same range and greatly weakening or completely eliminating the display of targets at a greater range.
4. Relatively low altitude aircraft will not be seen if they are screened by mountains or are below the radar beam due to curvature of the Earth.
5. The amount of reflective surface of an aircraft will determine the size of the radar return. Therefore, a small light airplane or a sleek jet fighter will be more difficult to see on primary radar than a large commercial jet or military bomber.
6. All ARTCC radar in the conterminous U.S. and many airport surveillance radar have the capability to interrogate Mode C and display altitude information to the controller from appropriately equipped aircraft. However, a number of airport surveillance radar do not have Mode C display capability; therefore, altitude information must be obtained from the pilot.



# The National Airspace System



## Introduction

The **National Airspace System (NAS)** is the network of United States (U.S.) airspace: air navigation facilities, equipment, services, airports or landing areas, aeronautical charts, information/services, rules, regulations, procedures, technical information, manpower, and material. Included are system components shared jointly with the military. The system's present configuration is a reflection of the technological advances concerning the speed and altitude capability of jet aircraft, as well as the complexity of microchip and satellite-based navigation equipment. To conform to international aviation standards, the U.S. adopted the primary elements of the classification system developed by the **International Civil Aviation Organization (ICAO)**.

This chapter discusses airspace classification; en route, terminal, approach procedures, and operations within the NAS.

## Airspace Classification

Airspace in the U.S. is designated as follows: [Figure 8-1]

**Class A**—Generally, that airspace from 18,000 feet mean sea level (MSL) up to and including flight level (FL) 600, including the airspace overlying the waters within 12 nautical miles (NM) of the coast of the 48 contiguous states and Alaska. Unless otherwise authorized, all pilots must operate their aircraft under instrument flight rules (IFR).

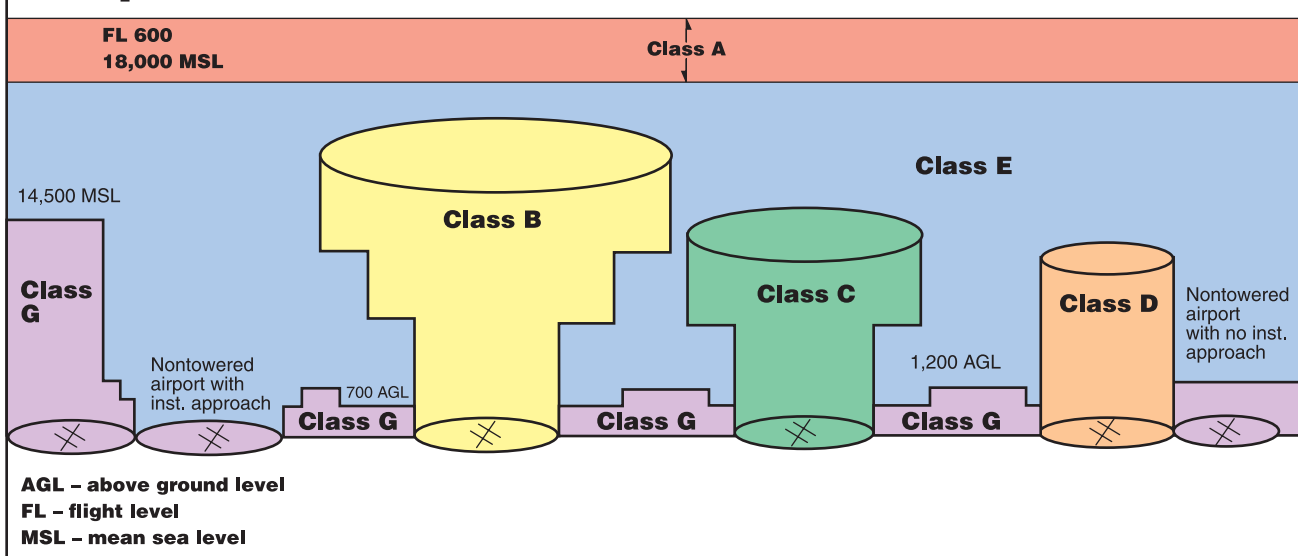
**National Airspace System (NAS):** The common network of U.S. airspace — air navigation facilities, equipment and services, airports or landing areas; aeronautical charts, information and services; rules, regulations and procedures, technical information, and manpower and material.

**International Civil Aviation Organization (ICAO):** The United Nations agency for developing the principles and techniques of international air navigation, and fostering planning and development of international civil air transport.

**Class B**—Generally, that airspace from the surface to 10,000 feet MSL surrounding the nation's busiest airports in terms of airport operations or passenger enplanements. The configuration of each Class B airspace area is individually tailored and consists of a surface area and two or more layers (some Class B airspace areas resemble upside-down wedding cakes), and is designed to contain all published instrument procedures once an aircraft enters the airspace. An air traffic control (ATC) clearance is required for all aircraft to operate in the area, and all aircraft that are so cleared receive separation services within the airspace.

**Class C**—Generally, that airspace from the surface to 4,000 feet above the airport elevation (charted in MSL) surrounding those airports that have an operational control tower, are serviced by a radar approach control, and have a certain number of IFR operations or passenger enplanements. Although the configuration of each Class C area is individually tailored, the airspace usually consists of a surface area with a 5 NM radius, an outer circle with a 10 NM radius that extends from 1,200 feet to 4,000 feet above the airport elevation and an outer area. Each person must establish two-way radio communications with the ATC facility providing air traffic services prior to entering the airspace and thereafter maintain those communications while within the airspace.

# Airspace Classification



Airspace	Class A	Class B	Class C	Class D	Class E	Class G
Entry Requirements	ATC clearance	ATC clearance	Prior two-way communications	Prior two-way communications	Prior two-way communications*	Prior two-way communications*
Minimum Pilot Qualifications	Instrument Rating	Private or Student certification. Local restrictions apply	Student certificate	Student certificate	Student certificate	Student certificate
Two-Way Radio Communications	Yes	Yes	Yes	Yes	Yes, under IFR flight plan*	Yes*
Special VFR Allowed	No	Yes	Yes	Yes	Yes	N/A
VFR Visibility Minimum	N/A	3 statute miles	3 statute miles	3 statute miles	3 statute miles**	1 statute mile†
VFR Minimum Distance from Clouds	N/A	Clear of clouds	500' below, 1,000' above, 2,000' horizontal	500' below, 1,000' above, 2,000' horizontal	500' below,** 1,000' above, 2,000' horizontal	Clear of clouds†
VFR Aircraft Separation	N/A	All	IFR aircraft	Runway Operations	None	None
Traffic Advisories	Yes	Yes	Yes	Workload permitting	Workload permitting	Workload permitting
Airport Application	N/A	<ul style="list-style-type: none"> <li>• Radar</li> <li>• Instrument Approaches</li> <li>• Weather</li> <li>• Control Tower</li> <li>• High Density</li> </ul>	<ul style="list-style-type: none"> <li>• Radar</li> <li>• Instrument Approaches</li> <li>• Weather</li> <li>• Control Tower</li> </ul>	<ul style="list-style-type: none"> <li>• Instrument Approaches</li> <li>• Weather</li> <li>• Control Tower</li> </ul>	<ul style="list-style-type: none"> <li>• Instrument Approaches</li> <li>• Weather</li> </ul>	<ul style="list-style-type: none"> <li>• Control Tower</li> </ul>

\*Only if a temporary tower or control tower is present is the exception.

\*\*Only true below 10,000 feet.

†Only true during day at or below 1,200 feet AGL (see 14 CFR part 91).

**Figure 8-1.** U.S. airspace classification.

**Class D**—Generally, that airspace from the surface to 2,500 feet above the airport elevation (charted in MSL) surrounding those airports that have an operational control tower. The configuration of each Class D airspace area is individually tailored and when instrument procedures are published, the airspace will normally be designed to contain the procedures. Arrival extensions for **instrument approach procedures (IAPs)** may be Class D or Class E airspace. Unless otherwise authorized, each person must establish two-way radio communications with the ATC facility providing air traffic services prior to entering the airspace and thereafter maintain those communications while in the airspace.

**Class E**—Generally, if the airspace is not Class A, Class B, Class C, or Class D, and it is controlled airspace, it is Class E airspace. Class E airspace extends upward from either the surface or a designated altitude to the overlying or adjacent controlled airspace. When designated as a surface area, the airspace will be configured to contain all instrument procedures. Also in this class are federal airways, airspace beginning at either 700 or 1,200 feet above ground level (AGL) used to transition to and from the terminal or en route environment, en route domestic, and offshore airspace areas designated below 18,000 feet MSL. Unless designated at a lower altitude, Class E airspace begins at 14,500 MSL over the U.S., including that airspace overlying the waters within 12 NM of the coast of the 48 contiguous states and Alaska, up to but not including 18,000 feet MSL, and the airspace above FL600.

**Class G**—That airspace not designated as Class A, B, C, D, or E. Class G airspace is essentially uncontrolled by ATC except when associated with a temporary control tower.

### **Special Use Airspace**

**Special use airspace** is the designation for airspace in which certain activities must be confined, or where limitations may be imposed on aircraft operations that are not part of those activities. Certain special use airspace areas can create limitations on the mixed use of airspace. The special use airspace depicted on instrument charts includes the area name or number, effective altitude, time and weather conditions of operation, the controlling agency, and the chart panel location. On National Aeronautical Charting Office (NACO) en route charts, this information is available on the panel opposite the air/ground (A/G) voice communications.

**Instrument approach procedures (IAPs):** A series of predetermined maneuvers for the orderly transfer of an aircraft under IFR from the beginning of the initial approach to a landing or to a point from which a landing may be made visually.

**Special use airspace:** Airspace in which certain activities are subject to restrictions that can create limitations on the mixed use of airspace. Consists of prohibited, restricted, warning, military operations, and alert areas.

**Prohibited areas** contain airspace of defined dimensions within which the flight of aircraft is prohibited. Such areas are established for security or other reasons associated with the national welfare. These areas are published in the Federal Register and are depicted on aeronautical charts. The area is charted as a “P” with a number (e.g., “P-123”). As the name implies, flight through this airspace is not permitted.

**Restricted areas** are areas where operations are hazardous to nonparticipating aircraft and contain airspace within which the flight of aircraft, while not wholly prohibited, is subject to restrictions. Activities within these areas must be confined because of their nature, or limitations imposed upon aircraft operations that are not a part of those activities, or both. Restricted areas denote the existence of unusual, often invisible, hazards to aircraft (e.g., artillery firing, aerial gunnery, or guided missiles). IFR flights may be authorized to transit the airspace and are routed accordingly. Penetration of restricted areas without authorization from the using or controlling agency may be extremely hazardous to the aircraft and its occupants. ATC facilities apply the following procedures when aircraft are operating on an IFR clearance (including those cleared by ATC to maintain visual flight rules (VFR)-On-Top) via a route that lies within joint-use restricted airspace:

1. If the restricted area is not active and has been released to the Federal Aviation Administration (FAA), the ATC facility will allow the aircraft to operate in the restricted airspace without issuing specific clearance for it to do so.
2. If the restricted area is active and has not been released to the FAA, the ATC facility will issue a clearance which will ensure the aircraft avoids the restricted airspace.

Restricted areas are charted with an “R” followed by a number (e.g., “R-5701”) and are depicted on the en route chart appropriate for use at the altitude or FL being flown.

**Warning areas** are similar in nature to restricted areas; however, the U.S. government does not have sole jurisdiction over the airspace. A warning area is airspace of defined dimensions, extending from 3 NM outward from the coast of the U.S., containing activity that may be hazardous to nonparticipating aircraft. The purpose of such areas is to warn nonparticipating pilots of the potential danger. A warning area may be located over domestic or international waters or both. The airspace is designated with a “W” and a number (e.g., “W-123”).

*Military operations areas (MOAs)* consist of airspace of defined vertical and lateral limits established for the purpose of separating certain military training activities from IFR traffic. Whenever an MOA is being used, nonparticipating IFR traffic may be cleared through an MOA if IFR separation can be provided by ATC. Otherwise, ATC will reroute or restrict nonparticipating IFR traffic. MOAs are depicted on sectional, VFR terminal area, and en route low altitude charts and are named rather than numbered (e.g., “Boardman MOA”).

*Alert areas* are depicted on aeronautical charts with an “A” and a number (e.g., “A-123”) to inform nonparticipating pilots of areas that may contain a high volume of pilot training or an unusual type of aerial activity. Pilots should exercise caution in alert areas. All activity within an alert area shall be conducted in accordance with regulations, without waiver, and pilots of participating aircraft, as well as pilots transiting the area shall be equally responsible for collision avoidance.

*Military Training Routes (MTRs)* are routes used by military aircraft to maintain proficiency in tactical flying. These routes are usually established below 10,000 feet MSL for operations at speeds in excess of 250 knots. Some route segments may be defined at higher altitudes for purposes of route continuity. Routes are identified as IFR (IR), and VFR (VR), followed by a number. MTRs with no segment above 1,500 feet AGL are identified by four number characters (e.g., IR1206, VR1207, etc.). MTRs that include one or more segments above 1,500 feet AGL are identified by three number characters (e.g., IR206, VR207, etc.). IFR Low Altitude En Route Charts depict all IR routes and all VR routes that accommodate operations above 1,500 feet AGL. IR routes are conducted in accordance with IFR regardless of weather conditions.

*Temporary flight restrictions (TFRs)* are put into effect when traffic in the airspace would endanger or hamper air or ground activities in the designated area. For example, a forest fire, chemical accident, flood, or disaster-relief effort could warrant a TFR, which would be issued as a Notice to Airmen (NOTAM).

*National Security Areas (NSAs)* consist of airspace of defined vertical and lateral dimensions established at locations where there is a requirement for increased security and safety of

ground facilities. Flight in NSAs may be temporarily prohibited by regulation under the provisions of Title 14 of the Code of Federal Regulations (14 CFR) part 99, and prohibitions will be disseminated via NOTAM.

### **Federal Airways**

The primary navigational aid (NAVAID) for routing aircraft operating under IFR is the **federal airways** system.

Each federal airway is based on a centerline that extends from one NAVAID or intersection to another NAVAID specified for that airway. A federal airway includes the airspace within parallel boundary lines 4 NM to each side of the centerline. As in all instrument flight, courses are magnetic, and distances are in NM. The airspace of a federal airway has a floor of 1,200 feet AGL, unless otherwise specified. A federal airway does not include the airspace of a prohibited area.

**Victor airways** include the airspace extending from 1,200 feet AGL up to, but not including 18,000 feet MSL. The airways are designated on sectional and IFR low altitude en route charts with the letter “V” followed by a number (e.g., “V23”). Typically, Victor airways are given odd numbers when oriented north/south and even numbers when oriented east/west. If more than one airway coincides on a route segment, the numbers are listed serially (e.g., “V287-495-500”). [Figure 8-2]

**Jet routes** exist only in Class A airspace, from 18,000 feet MSL to FL450, and are depicted on high-altitude en route charts. The letter “J” precedes a number to label the airway (e.g., J12).

### **Other Routing**

**Preferred IFR routes** have been established between major terminals to guide pilots in planning their routes of flight, minimizing route changes and aiding in the orderly management of air traffic on federal airways. Low and high altitude preferred routes are listed in the **Airport/Facility Directory (A/FD)**. To use a preferred route, reference the departure and arrival airports; if a routing exists for your flight, airway instructions will be listed.

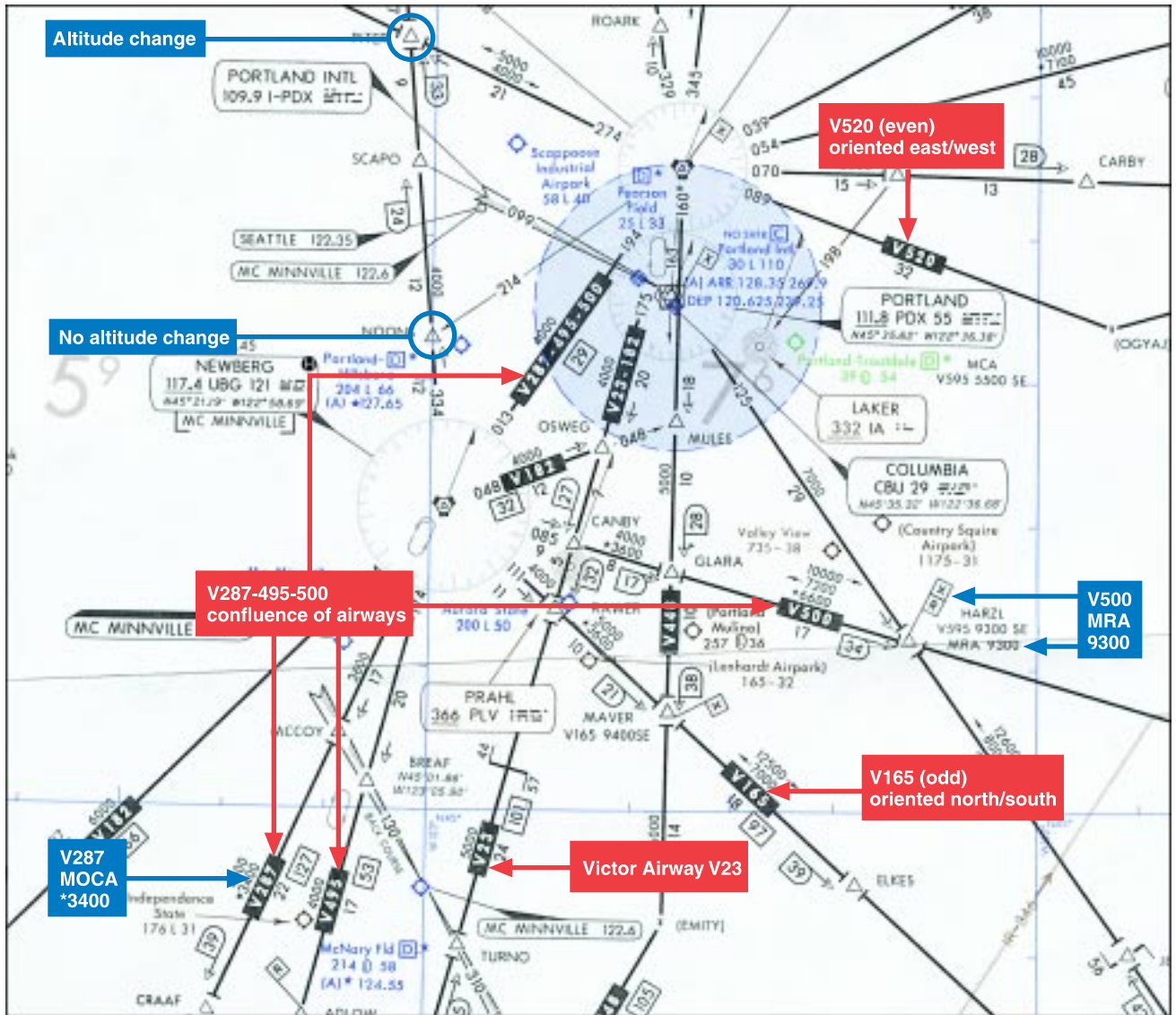
**Federal airways:** Class E airspace areas that extend upward from 1,200 feet to, but not including, 18,000 feet MSL, unless otherwise specified.

**Victor airways:** Except in Alaska and coastal North Carolina, the VOR airways are predicated solely on VOR or VORTAC navigation aids; they are depicted in blue on aeronautical charts.

**Jet routes:** A route designated to serve flight operations from 18,000 feet MSL, up to and including FL450.

**Preferred IFR routes:** Routes established in the major terminal and en route environments to increase system efficiency and capacity.

**Airport/Facility Directory (A/FD):** An FAA publication containing information on all airports, communications, and NAVAIDs pertinent to IFR flight.



**Figure 8-2.** Victor airways, and charted IFR altitudes.

**Tower En Route Control (TEC)** is an ATC program that uses overlapping approach control radar services to provide IFR clearances. By using TEC, you are routed by airport control towers. Some advantages include abbreviated filing procedures, fewer delays, and reduced traffic separation requirements. TEC is dependent upon the ATC’s workload and the procedure varies among locales.

**Tower En Route Control (TEC):** The control of IFR en route traffic within delegated airspace between two or more adjacent approach control facilities, designed to expedite traffic and reduce control and pilot communication requirements.

The latest version of Advisory Circular (AC) 90-91, *National Route Program*, provides guidance to users of the NAS for participation in the **National Route Program (NRP)**. All flights operating at or above FL290 within the conterminous U.S. are eligible to participate in the NRP, the primary purpose of which is to allow operators to plan minimum time/cost routes that may be off the prescribed route structure.

**National Route Program (NRP):** A set of rules and procedures designed to increase the flexibility of user flight planning within published guidelines.



Additionally, international flights to destinations within the U.S. are eligible to participate in the NRP within specific guidelines and filing requirements. NRP aircraft are not subject to route-limiting restrictions (e.g., published preferred IFR routes) beyond a 200 NM radius of their point of departure or destination.

## IFR En Route Charts

The objective of IFR en route flight is to navigate within the lateral limits of a designated airway at an altitude consistent with the ATC clearance. Your ability to fly instruments in the system, safely and competently, is greatly enhanced by understanding the vast array of data available to the pilot within the instrument charts. The NACO maintains the database and produces the charts for the U.S. government.

**En route high-altitude charts** provide aeronautical information for en route instrument navigation (IFR) at or above 18,000 feet MSL. Information includes the portrayal of jet routes, identification and frequencies of radio aids, selected airports, distances, time zones, special use airspace, and related information. Established routes from 18,000 feet MSL to FL450 use NAVAIDs not more than 260 NM apart. Scales vary from 1 inch = 45 NM to 1 inch = 18 NM. The charts are revised every 56 days.

To effectively depart from one airport and navigate en route under instrument conditions you need the appropriate **IFR en route low-altitude chart(s)**. The IFR low altitude en route chart is the instrument equivalent of the sectional chart. When folded, the cover of the NACO en route chart displays a map of the U.S. showing the coverage areas. Cities near congested airspace are shown in black type and their associated **area chart** is listed in the box in the lower left-hand corner of the map coverage box. Also noted is the highest off-route obstruction clearance altitude. The effective date of the chart is printed on the other side of the folded chart. Information concerning MTRs are also included on the chart cover. Scales vary from 1 inch = 5 NM to 1 inch = 20 NM. The en route charts are revised every 56 days.

When the NACO en route chart is unfolded, the legend is displayed and provides information concerning airports, NAVAIDs, air traffic services, and airspace.

**En route high-altitude charts:**  
Aeronautical charts for en route instrument navigation at or above 18,000 feet MSL.

**IFR en route low-altitude charts:**  
Aeronautical charts for en route IFR navigation in the low-altitude stratum.

Area navigation (RNAV) routes, including routes using global positioning system (GPS) for navigation, are not normally depicted on IFR en route charts. However, a number of RNAV routes have been established in the high-altitude structure and are depicted on the RNAV en route high altitude charts. RNAV instrument departure procedures (DPs) and standard terminal arrival routes (STARs) are contained in the U.S. Terminal Procedures booklets. The *Graphic Notices and Supplemental Data* also contains a tabulation of RNAV routes.

In addition to the published routes, you may fly a random RNAV route under IFR if it is approved by ATC. Random RNAV routes are direct routes, based on area navigation capability, between waypoints defined in terms of latitude/longitude coordinates, degree-distance fixes, or offsets from established routes/airways at a specified distance and direction.

Radar monitoring by ATC is required on all random RNAV routes. These routes can only be approved in a radar environment. Factors that will be considered by ATC in approving random RNAV routes include the capability to provide radar monitoring, and compatibility with traffic volume and flow. ATC will radar monitor each flight; however, navigation on the random RNAV route is the responsibility of the pilot.

Reliance on RNAV systems for instrument approach operations is becoming more commonplace as new systems, such as GPS and wide area augmentation system (WAAS) are developed and deployed. In order to foster and support full integration of RNAV into the NAS, the FAA has developed a charting format for RNAV approach charts.

## Airport Information

Airport information is provided in the legend, and the symbols used for the airport name, elevation, and runway length are similar to the sectional chart presentation. Instrument approaches can be found at airports with blue or green symbols, while the brown airport symbol denotes airports that do not have approved instrument approaches. Asterisks are used to indicate the part-time nature of tower operations, lighting facilities, and airspace classifications (consult the communications panel on the chart for primary radio frequencies and hours of operation). The asterisk could also indicate that approaches are not permitted during the


**Area chart:** Part of the low-altitude en route chart series, these charts furnish terminal data at a larger scale in congested areas.


nonoperating hours, and/or filing as an alternate is not approved during specified hours. A box after an airport name with a “C” or “D” inside indicates Class C and D airspace, respectively. [Figure 8-3]

### Charted IFR Altitudes

The **minimum en route altitude (MEA)** ensures a navigation signal strong enough for adequate reception by the aircraft navigation (NAV) receiver and adequate obstacle clearance along the airway. Communication is not necessarily guaranteed with MEA compliance. The obstacle clearance, within the limits of the airway, is typically 1,000 feet in nonmountainous areas and 2,000 feet in designated mountainous areas. MEAs can be authorized with breaks in the signal coverage; if this is the case, the NACO en route chart notes “MEA GAP” parallel to the affected airway. MEAs are usually bidirectional; however, they can be unidirectional. Arrows are used to indicate the direction to which the MEA applies.

The **minimum obstruction clearance altitude (MOCA)**, as the name suggests, provides the same obstruction clearance as an MEA; however, the NAV signal reception is only ensured within 22 NM of the closest NAVAID defining the route. The MOCA is listed below the MEA and indicated on NACO charts by a leading asterisk (e.g., “\*3400”—see figure 8-2, V287 at bottom left in figure).

The **minimum reception altitude (MRA)** identifies an intersection from an off-course NAVAID. If the reception is line-of-sight based, signal coverage will only extend to the MRA or above. However, if the aircraft is equipped with distance measuring equipment (DME) and the chart indicates the intersection can be identified with such equipment, the pilot could define the fix without attaining the MRA. On NACO charts, the MRA is indicated by the symbol  and the altitude preceded by “MRA” (e.g., “MRA 9300”). [Figure 8-2]

The **minimum crossing altitude (MCA)** will be charted when a higher MEA route segment is approached. The MCA is usually indicated when you are approaching steeply rising terrain, and obstacle clearance and/or signal reception is compromised. In this case, the pilot is required to initiate a climb so the MCA is reached by the time the intersection is crossed. On NACO charts, the MCA is indicated by the symbol,  the Victor airway number, and the direction to which it applies.

The **maximum authorized altitude (MAA)** is the highest altitude at which the airway can be flown without receiving conflicting navigation signals from NAVAIDs operating on the same frequency. Chart depictions appear as “MAA-15000.”

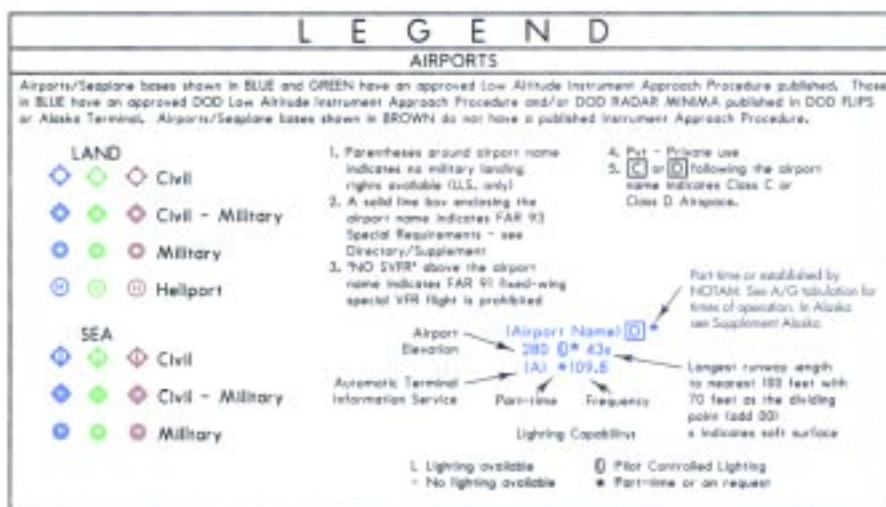


Figure 8-3. En route airport legend.


**Minimum en route altitude (MEA):** The lowest published altitude between radio fixes which ensures acceptable navigational signal coverage and meets obstacle clearance requirements between those fixes.

**Minimum obstruction clearance altitude (MOCA):** The lowest published altitude in effect between radio fixes on VOR airways, off-airway routes, or route segments which meets obstacle clearance requirements for the entire route segment and which ensures acceptable navigational signal coverage only within 25 statute (22 nautical) miles of a VOR.

**Minimum reception altitude (MRA):** The lowest altitude at which an airway intersection can be determined.

**Minimum crossing altitude (MCA):** The lowest altitude at certain fixes at which an aircraft must cross when proceeding in the direction of a higher MEA.

**Maximum authorized altitude (MAA):** A published altitude representing the maximum usable altitude or FL for an airspace structure or route segment.

When an MEA, MOCA, and/or MAA change on a segment other than a NAVAID, a sideways “T”  is depicted on the chart. If there is an airway break without the symbol, you can assume the altitudes have not changed (see the upper left area of figure 8-2). When a change of MEA to a higher MEA is required, the climb may commence at the break, ensuring obstacle clearance. [Figure 8-4B]




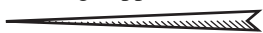
## Navigation Features

### Types of NAVAIDs



Very-high frequency omnidirectional ranges (VORs) are the principal NAVAIDs that support the Victor airways. Many other navigation tools are also available to the pilot. For example, nondirectional beacons (NDBs) can broadcast signals accurate enough to provide stand-alone approaches, and DME allows the pilot to pinpoint a reporting point on the airway. Though primarily navigation tools, these NAVAIDs can also transmit voice broadcasts.


Tactical air navigation (TACAN) channels are represented as the two- or three-digit numbers following the three-letter identifier in the NAVAID boxes. The NACO terminal procedures provide a frequency-pairing table for the TACAN-only sites. On NACO charts, very-high frequencies and ultra-high frequencies (VHF/UHF) NAVAIDs (e.g., VORs) are depicted in black, while low frequencies and medium frequencies (LF/MF) are depicted as brown. [Figure 8-4A]

### Identifying Intersections



Intersections along the airway route are established by a variety of NAVAIDs. An open triangle  indicates the location of an ATC reporting point at an intersection; if the triangle is solid,  a report is compulsory. [Figure 8-4B] NDBs, localizers, and off-route VORs are used to establish intersections. NDBs are sometimes colocated with intersections, in which case passage of the NDB would mark the intersection. A bearing to an off-route NDB also can provide intersection identification. The presence of a localizer course can be determined from a feathered arrowhead symbol on the en route chart.  If crosshatched markings appear on the left-hand side of the arrowhead, a  **back course (BC)** signal is transmitted. On NACO charts, the localizer symbol is depicted to identify an intersection.


**Back course (BC):** The reciprocal of the localizer course for an ILS. When flying a back-course approach, an aircraft approaches the instrument runway from the end on which the localizer antennas are installed.

When you travel on an airway, off-route VORs remain the most common means of identifying intersections. Arrows depicted next to the intersection  indicate the NAVAID to be used for identification. Another means of identifying an intersection is with the use of DME. A hollow arrowhead  indicates DME is authorized for intersection identification. If the DME mileage at the intersection is a cumulative distance of route segments, the mileage is totaled and indicated by a D-shaped symbol with a number inside.

 Typically, the distance numbers do not appear on the initial segment. [Figure 8-4B, Route Data] Approved IFR GPS units can also be used to report intersections if the intersection name resides in a current database.

### Other Route Information

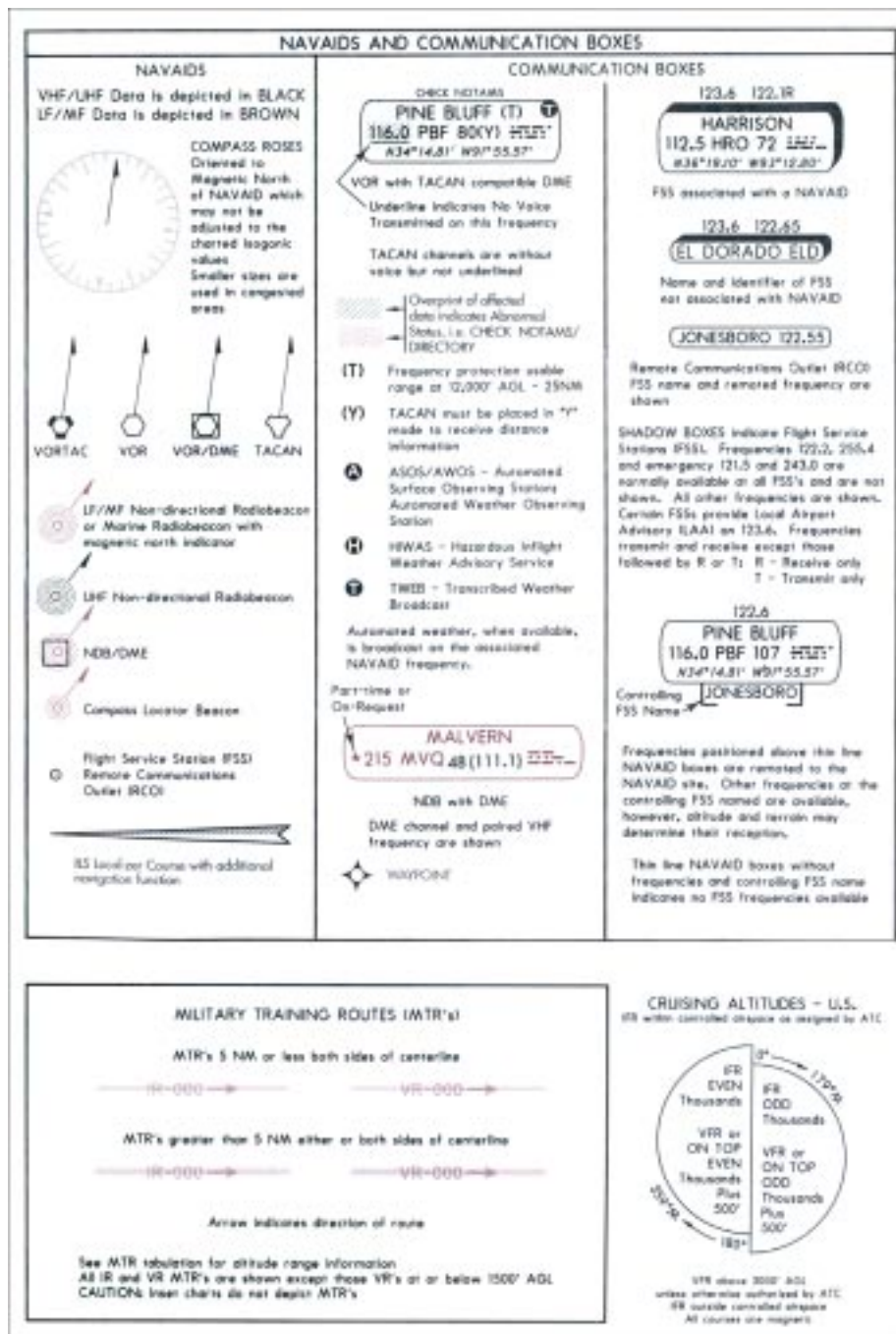
DME and GPS provide valuable route information concerning such factors as mileage, position, and groundspeed. Even without this equipment, information is provided on the charts for making the necessary calculations using time and distance. The en route chart depicts point-to-point distances on the airway system. Distances from VOR to VOR are charted with a number inside of a box.  To differentiate distances when two airways cross, the word “TO” with the three-letter VOR identifier appears next to the distance box. TO PDX 

VOR **changeover points (COPs)** are depicted on the charts by this symbol:  The numbers indicate the distance at which to change the VOR frequency. The frequency change might be required due to signal reception or conflicting frequencies. If a COP does not appear on an airway, the frequency should be changed midway between the facilities. A COP at an intersection often indicates a course change.

Occasionally an “x” will appear at a separated segment of an airway that is not an intersection. The “x” is a **mileage breakdown** or **computer navigation fix** and indicates a course change.

**Changeover points (COPs):** A point along the route where changeover in navigation guidance should occur.


**Mileage breakdown or computer navigation fix:** A fix indicating a course change that appears on the chart as an “x” at a break between two segments of a federal airway.



**Figure 8-4A.** Legend from en route low altitude chart. (Air Traffic Services and Airspace Information section of the legend is continued on the next page.)



Today's computerized system of ATC has greatly reduced the need for holding en route. However, published holding patterns are still found on charts at junctures where ATC has deemed it necessary to enable traffic flow. When a holding pattern is charted, the controller may provide the holding direction and the statement "as published." [Figure 8-4B]

Boundaries separating the jurisdiction of **Air Route Traffic Control Centers (ARTCC)** are depicted on charts with blue serrations.  The name of the controlling facility is printed on the corresponding side of the division line. ARTCC remote sites are depicted as blue serrated boxes and contain the center name, sector name, and the sector frequency. [Figure 8-4B]

### Weather Information and Communication Features

En route NAVAIDs also provide weather information and serve communication functions. When a NAVAID is shown as a shadowed box, an automated flight service station (AFSS) of the same name is directly associated with the facility. If an AFSS is located without an associated NAVAID, the shadowed box is smaller and contains only the name and identifier. The AFSS frequencies are provided on top of the box. (Frequency 122.2 and the emergency frequency 121.5 are not listed.)



A **Remote Communications Outlet (RCO)** associated with a NAVAID is designated by a fine-lined box with the controlling AFSS frequency on the top, and the name under the box, respectively. Without an associated facility, the fine-lined RCO box contains the AFSS name and remote frequency.



**Hazardous Inflight Weather Advisory Service (HIWAS)** and **Transcribed Weather Broadcast (TWEB)** are continuously transmitted over selected NAVAIDs and depicted in the NAVAID



**Air Route Traffic Control Center (ARTCC):** Established to provide ATC service to aircraft operating on IFR flight plans within controlled airspace and principally during the en route phase of flight.

**Remote Communications Outlet (RCO):** An unmanned communications facility remotely controlled by air traffic personnel.

**Hazardous Inflight Weather Advisory Service (HIWAS):** Recorded weather forecasts broadcast to airborne pilots over selected VORs.

**Transcribed Weather Broadcast (TWEB):** Meteorological and aeronautical data is recorded on tapes and broadcast over selected NAVAIDs.

box. HIWAS is depicted by a white "H" in a black circle in the upper left corner of the box; TWEB broadcasts show as a white "T" in a black circle in the upper right corner.

## U.S. Terminal Procedures Publications

While the en route charts provide the information necessary to safely transit broad regions of airspace, the **U.S. Terminal Procedures Publication (TPP)** enables pilots to guide their aircraft into airports. Terminal routes feed aircraft to a point where IAPs can be flown to a minimum altitude for landing. Whether for departing or arriving, these procedures exist to make the controllers' and pilots' jobs safer and more efficient. Available in booklets by region (published by the NACO), the TPP includes approach procedures, arrival and DPs, and airport diagrams.

### Departure Procedures (DPs)

**Departure procedures (DPs)** provide obstacle clearance protection to aircraft in instrument meteorological conditions (IMC), while reducing communications and departure delays. DPs are published in text and/or charted graphic form. Regardless of the format, all DPs provide a way to depart the airport and transition to the en route structure safely. When available, pilots are strongly encouraged to file and fly a DP at night, during marginal visual meteorological conditions (VMC), and IMC.

All DPs provide obstacle clearance provided the aircraft crosses the end of the runway at least 35 feet AGL; climbs to 400 feet above airport elevation before turning; and climbs at least 200 feet per nautical mile (FPNM), unless a higher climb gradient is specified to the assigned altitude. ATC may vector an aircraft off a previously assigned DP; however, the 200 FPNM or the FPNM specified in the DP, is required.

Textual DPs are listed by airport in the IFR Take-Off Minimums and Departure Procedures Section, Section C, of the TPP. Graphic DPs are depicted in the TPP following the approach procedures for the airport. [Figure 8-5]

**U.S. Terminal Procedures Publication (TPP):** Published by NACO in loose-leaf or perfect-bound volumes covering the conterminous U.S., Puerto Rico, and the Virgin Islands. Individual volumes in this series are entitled, *U.S. Terminal Procedures*, (name of region).

**Departure procedure (DP):** Preplanned IFR ATC departure/obstacle avoidance procedures, published for pilot use in textual and graphic format.



## Standard Terminal Arrival Routes (STARs)

**Standard terminal arrival routes (STARs)** depict prescribed routes to transition the instrument pilot from the en route structure to a fix in the terminal area from which an instrument approach can be conducted. If you do not have the appropriate STAR in your possession, you can write “No STAR” in the flight plan. However, if the controller is busy, you might be cleared along the same route and, if necessary, the controller will have you copy the entire text of the procedure.

Textual DPs and STARs are listed alphabetically at the beginning of the NACO booklet, and graphic DPs (charts) are included after the respective airport’s IAP. Figure 8-6 shows an example of a STAR, and the legend for STARs and DPs printed in NACO booklets.

## Instrument Approach Procedures Charts (IAPs)

The IAPs chart provides the method to descend and land safely in low visibility conditions. The FAA has established the IAPs after thorough analyses of obstructions, terrain features, and navigational facilities. Maneuvers, including altitude changes, course corrections, and other limitations, are prescribed in the IAPs. The approach charts reflect the criteria associated with the U.S. Standard for Terminal Instrument Approach Procedures (TERPs), which prescribes standardized methods for use in designing instrument flight procedures.

In addition to the NACO, other governmental and corporate entities produce approach procedures. The U.S. military IAPs are established and published by the Department of Defense and are available to the public upon request. Special IAPs are approved by the FAA for individual operators and are not available to the general public. Foreign country standard IAPs are established and published according to the individual country’s publication procedures. The information presented in the following sections will highlight features of the U.S. Terminal Procedures Publications.

The instrument approach chart is divided into five main sections, which include the margin identification, plan view, profile view, landing minimums (and notes), and airport diagram as shown in figure 8-7. An examination of each section follows.

**Standard terminal arrival route (STAR):** Preplanned IFR ATC arrival procedures, published for pilot use in textual and graphic format.

## Margin Identification

The **margin identification**, at the top and bottom of the chart, depicts the airport location and procedure identification. The approach plates are organized by city first, then airport name and state. For example, Spokane International in Spokane, Washington is alphabetically listed under “S” for Spokane.

The chart’s **amendment status** appears above the procedure identification in the top margin (and below in the bottom margin), along with the volume’s effective date. (The five-digit date format in the amendment, “00167” is read, “the 167th day of 2000.”) At the center of the top margin is the FAA chart reference number and approving authority and, at the bottom center, the airport’s latitude and longitude coordinates.

The procedure identification (top and bottom margin area of figure 8-7) is derived from the type of navigational facility providing final approach course guidance. A runway number is listed when the approach course is aligned within 30° of the runway centerline (e.g., “ILS RWY 19” or “VOR RWY 29”); this type of approach allows a straight-in landing under the right conditions. Some airports have parallel runways and simultaneous approach procedures. To distinguish between the left, right, and center runways, an “L,” “R,” or “C” follows the runway number (e.g., “ILS RWY 16R”). If the approach course diverges more than 30° from the runway centerline, a letter from the beginning of the alphabet is assigned (e.g., “VOR-A”). The letter designation signifies the expectation is for the procedure to culminate in a circling approach to land. In some cases, an airport might have more than one circling approach.

The navigational system required for the final approach segment can be determined by the procedure identification (top and bottom margin area of figure 8-7). The identification is derived from the type of navigational facility providing the final approach course guidance for straight-in approaches and the runway to which the course is aligned (e.g., ILS RWY 19 or RNAV RWY 29). Some airports have parallel runways and simultaneous approach procedures. To distinguish between the left, right, and center runways, an “L,” “R,” or “C” follows the runway number (e.g., NDB RWY 16R). For approaches that do not meet straight-in criteria, a letter from the beginning of the alphabet is assigned (e.g., VOR-A or LDA-B). The letter designation signifies the expectation is

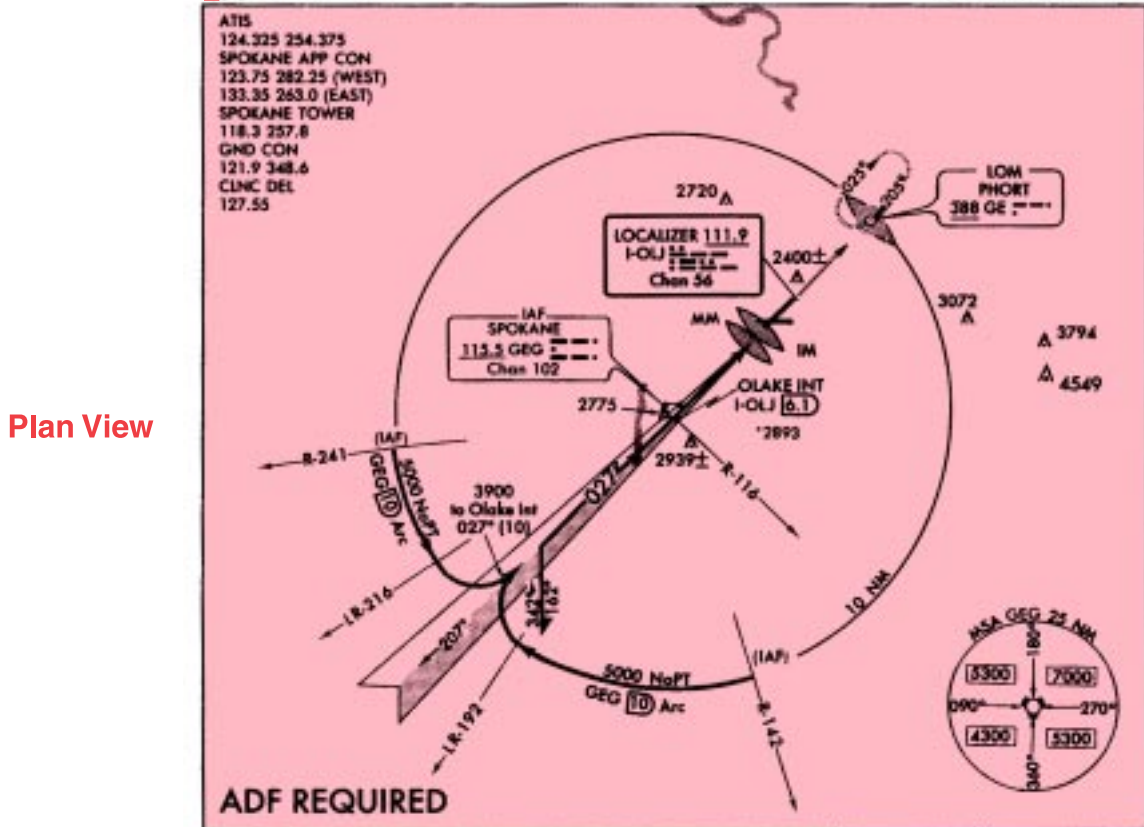
**Margin identification:** The top and bottom areas on an instrument approach chart that depict information about the procedure including airport location and procedure identification.

**Amendment status:** The circulation date and revision number of an instrument approach procedure, printed above the procedure identification.

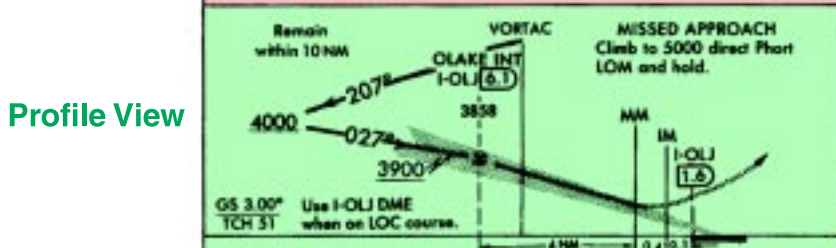




Amendments: Andrt 4 00167  
 Procedure ID: ILS RWY 3  
 Issue no. (Issuing authority): AL-403 (FAA)  
 Page number: 430  
 Coverage, effective date: NW-1, 15 JUN 2000  
 City/Airport name (ID): SPOKANE INTL (GEG)  
 City, state: SPOKANE, WASHINGTON



Plan View

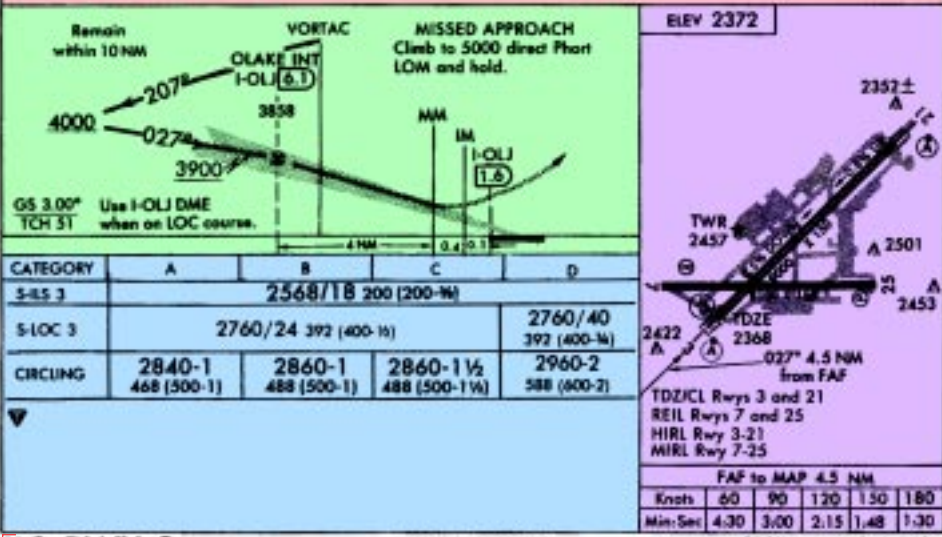


Profile View

CATEGORY	A	B	C	D
S-ILS 3	2568/18 200 (200-W)			
S-LOC 3	2760/24 392 (400-W)			2760/40 392 (400-W)
CIRCLING	2840-1	2860-1	2860-1 1/2	2960-2
	468 (500-1)	488 (500-1)	488 (500-1 1/2)	588 (600-2)

Landing Minimums (Notes)

Bottom margin identification



Airport Diagram

Time and speed table  
 City, state


Amendments: Andrt 4 00167  
 Procedure ID: ILS RWY 3  
 Lat./Long. coordinates: 47°37'N-117°32'W  
 City/Airport name (ID): SPOKANE INTL (GEG)  
 City, state: SPOKANE, WASHINGTON

Figure 8-7. Approach chart overview.

for the procedure to culminate in a circling approach to land. More than one navigational system separated by a slash indicates more than one type of equipment is required to execute the final approach (e.g., VOR/DME RWY 31). More than one navigational system separated by “or” indicates either type of equipment may be used to execute the final approach (e.g., VOR or GPS RWY 15). Multiple approaches of the same type, to the same runway, using the same guidance, have an additional letter from the end of the alphabet, number or term in the title (e.g., ILS Z RWY 28, Silver ILS RWY 28, or ILS 2 RWY 28). VOR/DME RNAV approaches are identified as VOR/DME RNAV RWY (runway number). Helicopters have special IAPs, designated with COPTER in the procedure identification (e.g., COPTER LOC/DME 25L). Other types of navigation systems may be required to execute other portions of the approach prior to intercepting the final approach segment or during the missed approach.



### The Plan View

The **plan view** provides a graphical overhead view of the procedure, and depicts the routes that guide the pilot from the en route segments to the initial approach fix (IAF). [Figure 8-7] During the initial approach, the aircraft has departed the en route phase of flight and is maneuvering to enter an intermediate or final segment of the instrument approach. An initial approach can be made along prescribed routes within the terminal area, which may be along an arc, radial, course, heading, radar vector, or a combination thereof. Procedure turns and high altitude teardrop penetrations are initial approach segments. Features of the plan view including the procedure turn, obstacle elevation, minimum safe altitude (MSA), and procedure track, are depicted in figure 8-8.

The majority of NACO charts contain a **reference** or **distance circle** with a 10 NM radius. Normally, approach features within the plan view are shown to scale; however, only the data within the reference circle is always drawn to scale. The circle is centered on an approach fix and has a radius of 10 NM, unless otherwise indicated. When a route segment, outside of the circle, is drawn to scale, the symbol  interrupts the segment.

Dashed circles, or **concentric rings** around the distance circle, are used when the information necessary to the procedure will not fit to scale within the limits of the plan view area. They serve as a means to systematically arrange this information in its relative position outside and beyond the reference circle. These concentric rings are labeled en route facilities and **feeder facilities**. The **en route facilities ring** depicts NAVAIDs, fixes, and intersections that are part of the en route low altitude airway structure used in the approach procedure. The feeder facilities ring includes radio aids to navigation, fixes and intersections used by ATC to direct aircraft to intervening facilities/fixes between the en route structure and the IAF. Feeder routes are not part of the en route structure.

The primary airport depicted in the plan view is drawn with enough detail to show the runway orientation and final approach course alignment. Airports other than the primary approach airport are not depicted in the NACO plan view.

Known spot elevations and obstacles are indicated on the plan view in MSL altitudes. The largest dot and number combination indicates the highest elevation. An inverted “V” with a dot in the center depicts an obstacle.  The highest obstacle is indicated with a bolder, larger version of the same symbol. Two interlocking inverted V’s  signify a group of obstacles. [Figure 8-8]

In the top left or right corner of the plan view is the communications area. Communication frequencies are generally listed in the order in which they would be used during arrival. Frequencies for weather and related facilities are included, where applicable, such as automatic terminal information service (ATIS), automated surface observing system (ASOS), automated weather observing system (AWOS) and AFSS’s.

**Plan view:** Overhead view of an approach procedure on an IAP chart.

**Reference circle (also, distance circle):** The circle depicted in the plan view of an IAP chart that typically has a 10 NM radius, within which elements are drawn to scale.

**Concentric rings:** The dashed-line circles depicted in the plan view of IAP charts, outside of the reference circle, that show en route and feeder facilities.

**Feeder facilities:** NAVAIDs used by ATC to direct aircraft to intervening fixes between the en route structure and the initial approach fix.

**En route facilities ring:** A circle depicted in the plan view of IAP charts, which designates NAVAIDs, fixes, and intersections that are part of the en route low altitude airway structure.

# LEGEND

## INSTRUMENT APPROACH PROCEDURES (CHARTS)

### PLANVIEW SYMBOLS

#### TERMINAL ROUTES

3100 NoPT 5.6 NM to GS Intcpt  
045°  
(14.2 to LOM)  
Minimum Altitude 2000  
Feeder Route 155°  
Mileage (15.1)

#### HOLDING PATTERNS

Holding pattern with max. restricted airspeed:  
"175K" applies to all altitudes.  
"210K" applies to altitudes above 6000' to and including 14000'.  
Limits will only be specified when they deviate from the standard. DME fixes may be shown.

#### REPORTING POINT/FIXES

Reporting Point  
▲ Name (Compulsory)      ✕ Fix or intersection  
△ Name (Non-Compulsory)

#### COMPUTER NAVIGATION FIX (CNF)

x (NAME) ("x" omitted when it conflicts with runway pattern)

13	DME Distance	ARC/DME/RNAV Fix
R-198	Radial line and value	
LR-198	Lead Radial	
LB-198	Lead Bearing	

#### MINIMUM SAFE ALTITUDE (MSA)

Facility Identifier      MSA CRW 25 NM

(arrows on distance circle identify sectors)

#### OBSTACLES

- Spot Elevation
- Highest Spot Elevation
- ▲ Obstacle
- ▲▲ Group of Obstacles
- ▲ Highest Obstacle
- ± Doubtful accuracy

#### SPECIAL USE AIRSPACE

R-352	R-Restricted	W-Warning
	P-Prohibited	A-Alert

#### RADIO AIDS TO NAVIGATION

110.1 Underline indicates No Voice transmitted on this frequency

- VOR    □ VOR/DME    ◊ TACAN    ◊ VORTAC
- ⊙ NDB    ⊙ NDB/DME    ✦ WAYPOINT
- ⊙ MAP WP    ⊙ FLYOVER WAYPOINT    ✦ WAYPOINT COLLOCATED WITH NAVAID
- ◊ LOM/LMM (Compass locator at Outer Marker/Middle Marker)
- ◊ Marker Beacon
- ▬ Localizer (LOC/LDA) Course  
Right side shading: Front course; Left side shading: Back Course
- ▬ SDF Course
- ▬ 180° MLS Approach Azimuth

MLS Identifier      MICROWAVE Chan 514 (Y) TACAN must be in "Y" mode to receive distance information.  
M-VDZ      Glidepath 6.20°  
DME 111.5 Chan 48(Y)

- ◻ LOC/DME
- LOC/LDA/SDF/MLS Transmitter (shown when installation is offset from its normal position off the end of the runway.)

#### Waypoint Data

Coordinates	PRAYS	Waypoint Name
Frequency	N38° 58.30' W89° 51.50'	
Identifier	112.7 CAP 187.1°-56.2	
Reference Facility Elevation	590	Radial-Distance (Facility to Waypoint)

#### Primary Navaid with Coordinate Values

LIMA	
114.5 LIM	
Chan 92	
512°00.80'	
W77°07.00'	

#### Secondary Navaid

LMM	
LIMA	
248 NT	

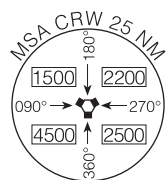
#### MISCELLANEOUS

- ▬ VOR Changeover Point
- ▬ RWY 15 512°00.52' End of Rwy Coordinates (DOD only)  
W77°06.91'
- ▬ Distance not to scale
- ▬ International Boundary

# LEGEND

Figure 8-8. IAP plan view symbols legend.

The **minimum safe altitude (MSA)** circle appears in the plan view, except in approaches for which appropriate NAVAIDs (e.g., VOR or NDB) are unavailable. The MSA is provided for emergency purposes only and guarantees 1,000 feet obstruction clearance in the sector indicated with reference to the bearing in the circle. For conventional navigation systems, the MSA is normally based on the primary omnidirectional facility on which the IAP is predicated. The MSA depiction on the approach chart contains the facility identifier of the NAVAID used to determine the MSA altitudes. For RNAV approaches, the MSA is based on the runway waypoint for straight-in approaches, or the airport waypoint for circling approaches. For GPS approaches, the MSA center will be the missed approach waypoint. The MSL altitudes appear in boxes within the circle, which is typically a 25 NM radius unless otherwise indicated. The MSA circle refers to the letter identifier of the NAVAID or waypoint that describes the center of the circle. MSAs are not depicted on terminal arrival area (TAA) approach charts.



NAVAIDs, included in the plan view, are necessary for the completion of the instrument procedure and include the facility name, frequency, letter identifier, and Morse code sequence. A heavy-lined NAVAID box depicts the primary NAVAID used for the approach. An “I” in front of the NAVAID identifier (in figure 8-7, “I-OLJ”) listed in the NAVAID box indicates a localizer and a TACAN channel (which signifies DME availability). The requirement for an ADF, DME or RADAR in the approach is noted in the plan view.

Intersections, fixes, radials, and course lines describe route and approach sequencing information. The main procedure, or final approach course is a thick, solid line. A DME arc, which is part of the main procedure course, is also represented as a thick, solid line. A feeder route is depicted with a medium line and provides heading, altitude, and distance information. (All three components must be designated on the chart to provide a navigable course.) Radials, such as lead radials, are shown by thin lines. The missed approach track is drawn using a thin dashed line with a directional arrow. A visual flight path segment appears as a thick

dashed line with a directional arrow. Visual Flight Path

**Initial approach fixes (IAFs)** are charted IAF when associated with a NAVAID or when freestanding.

The missed approach holding pattern track is represented with a thin-dashed line. When collocated, the missed approach holding pattern and procedure turn holding pattern are indicated as a solid, black line. Arrival holding patterns are depicted as thin, solid lines.

### Course Reversal Elements in Plan View and Profile View

Course reversals are included in an IAP, are depicted in one of three different ways, a 45°/180° procedure, a holding pattern, or a teardrop procedure. The maneuvers are required when it is necessary to reverse direction to establish the aircraft inbound on an intermediate or final approach course. Components of the required procedure are depicted in the plan view and the profile view. The maneuver must be completed within the distance and at the minimum altitude specified in the profile view. Pilots should coordinate with the appropriate ATC facility relating to course reversal during the IAP.

#### Procedure Turns

A **procedure turn** barbed arrow indicates the direction or side of the outbound course on which the procedure turn is made. Headings are provided for course reversal using the 45° procedure turn. However, the point at which the turn may be commenced, and the type and rate of turn is left to the discretion of the pilot. Some of the options are the 45° procedure turn, the racetrack pattern, the teardrop procedure turn, or the 80°/260° course reversal. The absence of the procedure turn barbed arrow in the plan view indicates that a procedure turn is not authorized for that procedure. A maximum procedure turn speed of not greater than 200 knots indicated airspeed (KIAS) should be observed when turning outbound over the IAF and throughout the procedure turn maneuver to ensure staying within the obstruction clearance area. The normal procedure turn distance is 10 NM. This may be reduced to a minimum of 5 NM where only Category A or helicopter aircraft are operated, or increased to as much as 15 NM to accommodate high performance aircraft. Descent below the procedure turn altitude begins after the aircraft is established on the inbound course.

**Minimum safe altitude (MSA):** The minimum altitude depicted on approach charts which provides at least 1,000 feet of obstacle clearance for emergency use within a specified distance from the listed navigation facility or waypoint.

**Initial approach fix (IAF):** The fixes depicted on IAP charts that identify the beginning of the initial approach segment(s).

**Procedure turn:** The maneuver prescribed when it is necessary to reverse direction to establish an aircraft on the intermediate approach segment or final approach course.

The procedure turn is *not* required when the symbol “NoPT” appears, when radar vectoring to the final approach is provided, when conducting a timed approach, or when the procedure turn is not authorized. Pilots should contact the appropriate ATC facility when in doubt if a procedure turn is required.

### *Holding in Lieu of Procedure Turn*

A holding pattern in lieu of a procedure turn may be specified for course reversal in some procedures. In such cases, the holding pattern is established over an intermediate fix or a **final approach fix (FAF)**. The holding pattern distance or time specified in the profile view must be observed. Maximum holding airspeed limitations as set forth for all holding patterns apply. The holding pattern maneuver is completed when the aircraft is established on the inbound course after executing the appropriate entry. If cleared for the approach prior to returning to the holding fix, and the aircraft is at the prescribed altitude, additional circuits of the holding pattern are not necessary nor expected by ATC. If pilots elect to make additional circuits to lose excessive altitude or to become better established on course, it is their responsibility to advise ATC upon receipt of their approach clearance. When holding in lieu of a procedure turn, the holding pattern must be followed, *except* when RADAR VECTORING to the final approach course is provided or when NoPT is shown on the approach course.

### *Teardrop Procedure*

When a teardrop procedure turn is depicted and a course reversal is required, unless otherwise authorized by ATC, this type of procedure must be executed. The teardrop procedure consists of departure from an IAF on the published outbound course followed by a turn toward and intercepting the inbound course at or prior to the intermediate fix or point. Its purpose is to permit an aircraft to reverse direction and lose considerable altitude within reasonably limited airspace. Where no fix is available to mark the beginning of the intermediate segment, it shall be assumed to commence at a point 10 NM prior to the FAF. When the facility is located on the airport, an aircraft is considered to be on final approach upon completion of the penetration turn. However, the final approach segment begins on the final approach course 10 NM from the facility.

**NoPT (No Procedure Turn):** Used with the appropriate course and altitude to denote the procedure turn is not required.

**Final approach fix (FAF):** The fix from which the IFR final approach to an airport is executed, which identifies the beginning of the final approach segment.

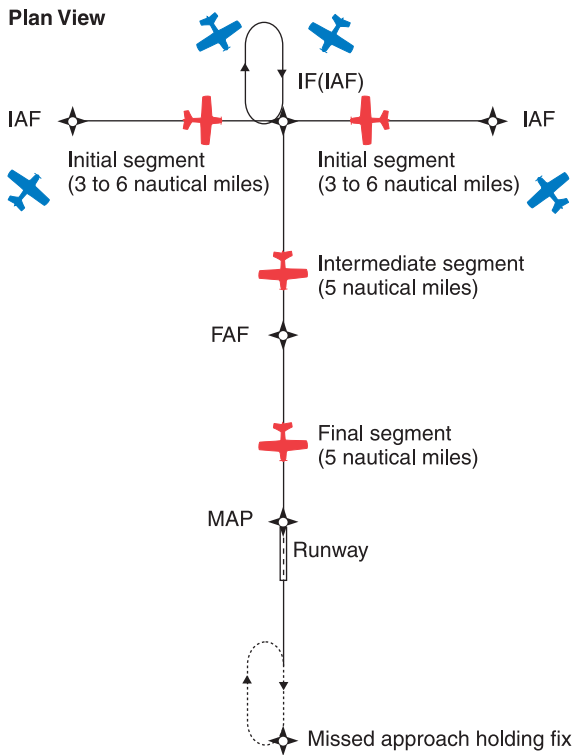
## **Terminal Arrival Area (TAA)**

The design objective of the terminal arrival area (TAA) procedure is to provide a transition method for arriving aircraft with GPS/RNAV equipment. TAAs will also eliminate or reduce the need for feeder routes, departure extensions, and procedure turns or course reversal. The TAA is controlled airspace established in conjunction with the standard or modified RNAV approach configurations.

The standard TAA has three areas: straight-in, left base, and right base. The arc boundaries of the three areas of the TAA are published portions of the approach and allow aircraft to transition from the en route structure direct to the nearest IAF. When crossing the boundary of each of these areas or when released by ATC within the area, the pilot is expected to proceed direct to the appropriate waypoint IAF for the approach area being flown. A pilot has the option in all areas of proceeding directly to the holding pattern.

The TAA has a “T” structure that normally provides a NoPT for aircraft using the approach. [Figure 8-9] The TAA provides the pilot and air traffic controller with an efficient method for routing traffic from the en route to the terminal structure. The basic “T” contained in the TAA normally aligns the procedure on runway centerline, with the missed approach point (MAP) located at the threshold, the FAF 5 NM from the threshold, and the intermediate fix (IF) 5 NM from the FAF.

In order to accommodate descent from a high en route altitude to the initial segment altitude, a hold in lieu of a procedure turn provides the aircraft with an extended distance for the necessary descent gradient. The holding pattern constructed for this purpose is always established on the center IAF waypoint. Other modifications may be required for parallel runways, or due to operational requirements. When published, the RNAV chart will depict the TAA through the use of “icons” representing each TAA associated with the RNAV procedure. These icons will be depicted in the plan view of the approach plate, generally arranged on the chart in accordance with their position relative to the aircraft’s arrival from the en route structure.



**Figure 8-9.** Basic “T” Design of Terminal Arrival Area (TAA).

### The Profile View

The **profile view** is a drawing of the side view of the procedure and illustrates the vertical approach path altitudes, headings, distances, and fixes. [Figure 8-7] The view includes the minimum altitude and maximum distance for the procedure turn, altitudes over prescribed fixes, distances between fixes, and the missed approach procedure. The profile view aids in the pilot’s interpretation of the IAP. The profile view is not drawn to scale. [Figures 8-10 and 8-11]

The precision approach **glide-slope intercept altitude** is a minimum altitude for glide slope interception after completion of the procedure turn, illustrated by an altitude number and “zigzag” line. ⚡ It applies to precision approaches, and except where otherwise prescribed, also applies as a minimum altitude for crossing the FAF when the glide slope is inoperative or not used. Precision approach

**Profile view:** Side view of an approach procedure on an IAP chart illustrating the vertical approach path altitudes, headings, distances, and fixes.

**Glide-slope intercept altitude:** The minimum altitude of an intermediate approach segment prescribed for a precision approach that ensures obstacle clearance.

**Stepdown fix:** Permits additional descent within a segment of an IAP by identifying a point at which an obstacle has been safely overflown.

**Minimum descent altitude (MDA):** The lowest altitude (in feet MSL) to which descent is authorized in execution of a nonprecision IAP.

profiles also depict the glide-slope angle of descent, threshold-crossing height (TCH), and glide-slope altitude at the outer marker (OM).

In nonprecision approaches, a final descent is initiated at the FAF, or after completing the procedure turn and established inbound on the procedure course. The FAF is clearly identified by use of the Maltese cross symbol in the profile view. ✖ When the FAF is not indicated in the profile view, the MAP is based on station passage when the facility is on the airport or a specified distance (e.g., VOR/DME or GPS procedures).

**Stepdown fixes** in nonprecision procedures are provided between the FAF and the airport for authorizing a lower **minimum descent altitude (MDA)** after passing an obstruction. Stepdown fixes can be identified by NAVAID, NAVAID fix, waypoint, radar, and are depicted by a vertical dashed line. ⋮ Normally, there is only one stepdown fix between the FAF and the MAP, but there can be several. If the stepdown fix cannot be identified for any reason, the minimum altitude at the stepdown fix becomes the MDA for the approach. However, circling minimums apply if they are higher than the stepdown fix minimum altitude, and a circling approach is required.

The **visual descent point (VDP)** is a defined point on the final approach course of a nonprecision straight-in approach procedure. A normal descent from the MDA to the runway touchdown point may be commenced, provided visual reference is established. The VDP is identified on the profile view of the approach chart by the symbol “V.” [Figure 8-11]

The **missed approach point (MAP)** varies depending upon the approach flown. For the ILS, the MAP is at the decision altitude/decision height (DA/DH). In nonprecision procedures, the pilot determines the MAP by timing from FAF when the approach aid is well away from the airport, by a fix or NAVAID when the navigation facility is located on the field, or by waypoints as defined by GPS or VOR/DME RNAV. The pilot may execute the MAP early, but pilots should, unless otherwise cleared by ATC, fly the IAP as specified on the approach plate to the MAP at or above the MDA or DA/DH before executing a turning maneuver.

**Visual descent point (VDP):** A defined point on the final approach course of a nonprecision straight-in approach procedure from which normal descent from the MDA to the runway touchdown point may be commenced, provided the runway environment is clearly visible to the pilot.

**Missed approach point (MAP):** A point prescribed in each instrument approach at which a missed approach procedure shall be executed if the required visual reference has not been established.

# LEGEND

## INSTRUMENT APPROACH PROCEDURES (CHARTS)

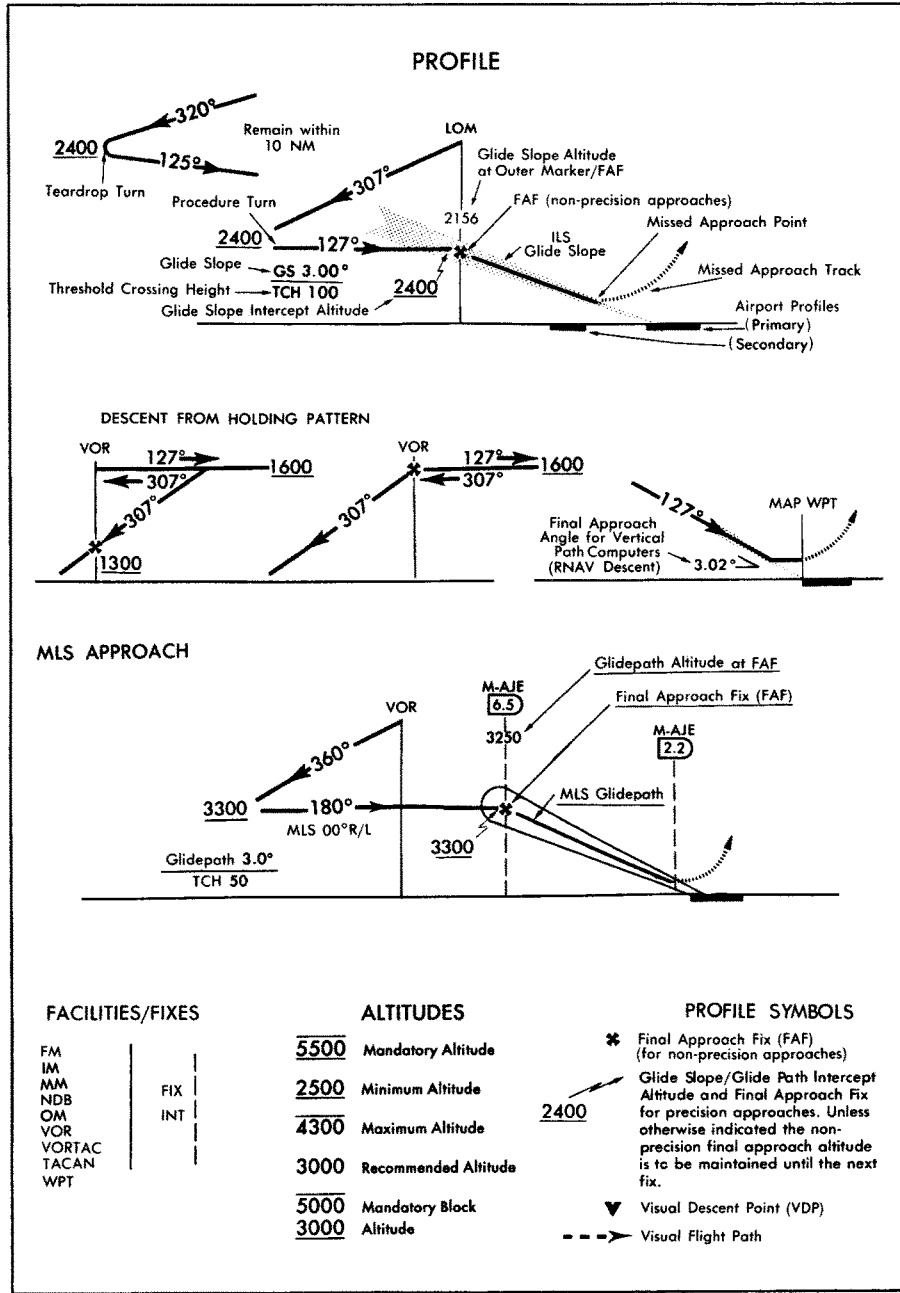


Figure 8-10. IAP profile legend.



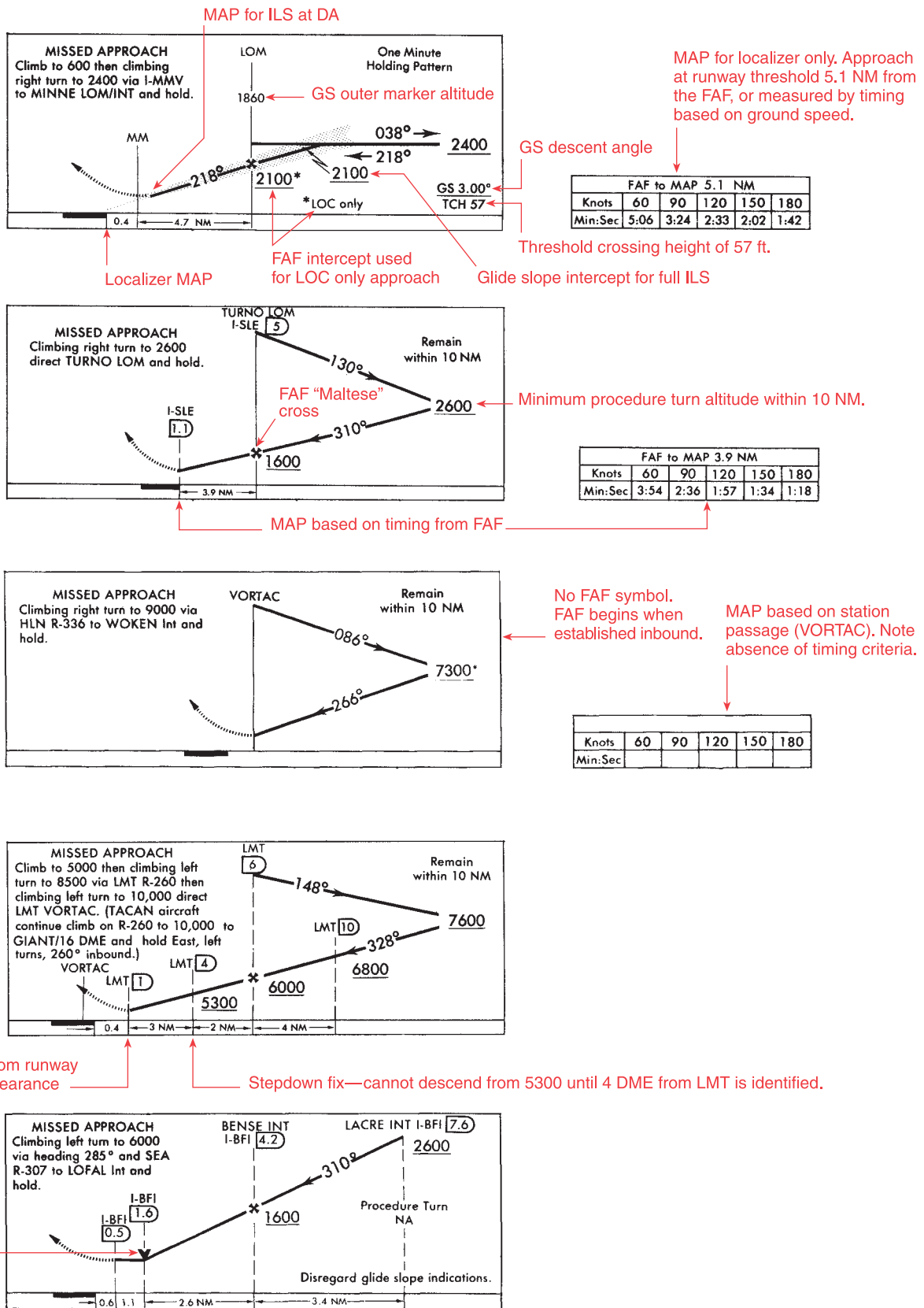


Figure 8-11. More IAP profile view features.

A complete description of the **missed approach procedure** appears in the profile view. [Figure 8-11] When initiating a missed approach, the pilot will be directed to climb straight ahead (e.g., “Climb to 2,500”), or commence a turning climb to a specified altitude (e.g., “Climbing left turn to 2,500”). In some cases, the procedure will direct the pilot to climb straight ahead to an initial altitude, then turn or enter a climbing turn to the holding altitude (e.g., “Climb to 900, then climbing right turn to 2,500 direct ABC VOR and hold”).

When the missed approach procedure specifies holding at a facility or fix, the pilot proceeds according to the missed approach track and pattern depicted on the plan view. An alternate missed approach procedure may also be issued by ATC. The textual description will also specify the NAVAID(s) or radials that identify the holding fix.

The profile view also depicts minimum, maximum, recommended, and mandatory block altitudes used in approaches. The minimum altitude is depicted with the altitude underscored, 2500. On final approach, aircraft are required to maintain an altitude at or above the depicted altitude until reaching the subsequent fix. The maximum altitude will be depicted with the altitude overscored,  $\overline{4300}$  and aircraft must remain at or below the depicted altitude. Mandatory altitude will be depicted with the altitude both underscored and overscored,  $\overline{\underline{5500}}$  and altitude is to be maintained at the depicted value. Recommended altitudes are advisory altitudes and are neither over- nor underscored. When an over- or underscore spans two numbers, a mandatory block altitude is indicated, and aircraft are required to maintain altitude within the range of the two numbers. [Figures 8-10 and 8-11]

### Minimums and Notes

The **minimums section** sets forth the lowest altitude and visibility requirements for the approach, whether precision or nonprecision, straight-in or circling, or radar vectored. When a fix is incorporated in a nonprecision final segment,

two sets of minimums may be published, depending upon whether or not the fix can be identified. Two sets of minimums may also be published when a second altimeter source is used in the procedure. The minimums ensure that final approach obstacle clearance is provided from the start of the final segment to the runway or MAP, whichever occurs last. The same minimums apply to both day and night operations unless different minimums are specified in the Notes section. Published circling minimums provide obstacle clearance when pilots remain within the appropriate area of protection. [Figure 8-12]

Minimums are specified for various **aircraft approach categories** based upon a value 1.3 times the stalling speed of the aircraft in the landing configuration at maximum certified gross landing weight. If it is necessary to maneuver at speeds in excess of the upper limit of a speed range for a category, the minimums for the next higher category should be used. For example, an aircraft that falls into category A, but is circling to land at a speed in excess of 91 knots, should use approach category B minimums when circling to land. [Figure 8-13]

The minimums for straight-in and circling appear directly under each aircraft category. [Figure 8-12] When there is no solid division line between minimums for each category on the rows for straight-in or circling, the minimums apply to the two or more undivided categories.

The terms used to describe the minimum approach altitudes differ between precision and nonprecision approaches. Precision approaches use **decision altitude (DA)**, charted in “feet MSL,” followed by the **decision height (DH)** which is referenced to the **height above threshold elevation (HAT)**. Nonprecision approaches use MDA, referenced to “feet MSL.” The minimums are also referenced to HAT for straight-in approaches, or **height above airport (HAA)** for circling approaches. On NACO charts, the figures listed parenthetically are for military operations and are not used in civil aviation.

**Missed approach procedure:** A maneuver performed by a pilot when an instrument approach cannot be completed to a landing.

**Minimums section:** The area on an IAP chart that displays the lowest altitude and visibility requirements for the approach.

**Aircraft approach category:** A performance grouping of aircraft based on a speed of 1.3 times their stall speed in the landing configuration at maximum gross landing weight.

**Decision altitude (DA):** A specified altitude in the precision approach, charted in “feet MSL,” at which a missed approach must be initiated if the required visual reference to continue the approach has not been established.

**Decision height (DH):** A specified altitude in the precision approach, charted in “height above threshold elevation,” at which a decision must be made to either continue the approach or to execute a missed approach.

**Height above threshold elevation (HAT):** The DA/DH or MDA above the highest runway elevation in the touchdown zone (first 3,000 feet of the runway).

**Height above airport (HAA):** The height of the MDA above the published airport elevation.

## TERMS, LANDING MINIMA DATA

### IFR LANDING MINIMA

The United States Standard for Terminal Instrument Procedures (TERPS) is the approved criteria for formulating instrument approach procedures. Landing minima are established for six aircraft approach categories (ABCDE and COPTER). In the absence of COPTER MINIMA, helicopters may use the CAT A minimums of other procedures. The standard format for RNAV minima and landing minima portrayal follows:

### RNAV MINIMA

CATEGORY	A	B	C	D
GLS PA DA	1382/24		200 (200-1/2)	
LNAV/DA VNAV	1500/24		318 (400-1/2)	1500/40 318 (400-3/4)
LNAV MDA	1700/24	518 (600-1/2)	1700/50 518 (600-1)	1700/60 518 (600-1 1/4)
CIRCLING	1760-1	578 (600-1)	1760-1 1/2 578 (600-1 1/2)	1760-2 578 (600-2)

RNAV minimums are dependent on navigation equipment capability, as stated in the applicable AFM or AFMS and as outlined below.

### GLS (Global Navigation System (GNSS) Landing System)

Must have WAAS (Wide Area Augmentation System) equipment approved for precise approach. Note: "PA" indicates that the runway environment, i.e., runway markings, runway lights, parallel taxiway, etc., meets precision approach requirements. If the GLS minimums line does not contain "PA", then the runway environment does not support precision requirements.

### LNAV/VNAV (Lateral Navigation/Vertical Navigation)

Must have WAAS equipment approved for precision approach, or RNP-0.3 system based on GPS or DME/DME, with an IFR approach approved Baro-VNAV system. Other RNAV approach systems require special approval. Use of Baro-VNAV systems is limited by temperature, i.e., "Baro-VNAV NA below -20 C(-4 F)". (Not applicable if chart is annotated "Baro-VNAV NA".)

NOTE: DME/DME based RNP-0.3 systems may be used only when a chart note indicates DME/DME availability, for example, "DME/DME RNP-0.3 Authorized." Specific DME facilities may be required, for example: "DME/DME RNP-0.3 Authorized. ABC, XYZ required."

### LNAV (Lateral Navigation)

Must have IFR approach approved WAAS, GPS, GPS based FMS systems, or RNP-0.3 systems based on GPS or DME/DME. Other RNAV approach systems require special approval.

NOTE: DME/DME based RNP-0.3 systems may be used only when a chart note indicates DME/DME availability, for example, "DME/DME RNP-0.3 Authorized." Specific DME facilities may be required, for example: "DME/DME RNP-0.3 Authorized. ABC, XYZ required."

### LANDING MINIMA FORMAT

In this example airport elevation is 1179, and runway touchdown zone elevation is 1152.

CATEGORY	A	B	C	D
S-ILS 27	1352/24		200 (200-1/2)	
S-LOC 27	1440/24	288	(300-1/2)	1440/50 228 (300-1)
CIRCLING	1540-1 361 (400-1)	1640-1 461 (500-1)	1640-1 1/2 461 (500-1 1/2)	1740-2 561 (600-2)

Straight-in ILS to Runway 27  
 DH  
 Visibility (RVR 100's of feet)  
 Aircraft Approach Category  
 All minimums in parentheses not applicable to Civil Pilots.  
 MDA  
 HAA  
 Visibility in Statute Miles  
 Military Pilots refer to appropriate regulations.  
 Straight-in with Glide Slope Inoperative or not used to Runway 27

## Example of a Specific Radar Approach

### RADAR INSTRUMENT APPROACH MINIMUMS

OAK HARBOR, WA Amdt. 1. NOV 20, 1986 ELEV 189  
OAK HARBOR AIR PARK  
RADAR - 118.2 286 0

ASR	RWY	GS/TCH/RPI	CAT	DH/MDA-VIS	HAT/HAA CEIL-VIS	CAT	DH/MDA-VIS	HAT/HAA CEIL-VIS
ASR	25		AB	600-1	411 (500-1)	CD	NA	
	7		AB	600-1	450 (500-1)	CD	NA	
CIRCLING			AB	640-1	451 (500-1)	CD	NA	
			WHIDBEY ALTIMETER SETTING					
ASR	25		AB	900-1	711 (800-1)	CD	NA	
	7		AB	900-1	750 (800-1)	CD	NA	
CIRCLING			AB	900-1	711 (800-1)	CD	NA	

Circling NA North of Rwy 7-25  
When control zone not in effect, use Whidbey altimeter setting.  
NA

Figure 8-12. IAP landing minimums.

Category	Maneuvering Table	Circling Approach Area Radii
A	0-90 knots	1.3 miles
B	91-120 knots	1.5 miles
C	121-140 knots	1.7 miles
D	141-165 knots	2.3 miles
E	166 knots or more	4.5 miles

Figure 8-13. Aircraft approach categories and circling limits.

RVR (feet)	Visibility (statute miles)
1,600	1/4
2,400	1/2
3,200	5/8
4,000	3/4
4,500	7/8
5,000	1
6,000	1 1/4


Figure 8-14. RVR conversion table.

Visibility figures are provided in statute miles or **runway visual range (RVR)**, which is reported in hundreds of feet. RVR is measured by a transmissometer, which represents the horizontal distance measured at points along the runway. It is based on the sighting of either high intensity runway lights or on the visual contrast of other targets, whichever yields the greater visual range. RVR is horizontal visual range, not slant visual range, and is used in lieu of prevailing visibility in determining minimums for a particular runway. [Figure 8-14]


Visibility figures are depicted after the DA/DH or MDA in the minimums section. If visibility in statute miles is indicated, an altitude number, hyphen, and a whole or fractional number appear; for example, 530-1, which indicates "530 feet MSL" and 1 statute mile visibility, this is the descent minimum for the approach. The RVR value is separated from the minimum altitude with a slash, such as

**Runway visual range (RVR):** The instrumentally-derived horizontal distance a pilot should be able to see down the runway from the approach end, based on either the sighting of high-intensity runway lights, or the visual contrast of other objects.

“1065/24,” which indicates 1,065 feet MSL and an RVR of 2,400 feet. If RVR were prescribed for the procedure, but not available, a conversion table would be used to provide the equivalent visibility—in this case, of 1/2 statute mile visibility. [Figure 8-14] The conversion table is also available in the TPP.

When an **alternate airport** is required, standard IFR alternate minimums apply. Precision approach procedures require a 600-foot ceiling and 2 statute miles visibility; nonprecision approaches require an 800-foot ceiling and 2 statute miles visibility. When a black triangle with a white “A” appears in the Notes section of the approach chart, it indicates non-standard IFR alternate minimums exist for the airport. If an “NA” appears after the “A”  NA alternate minimums are not authorized. This information is found in the beginning of the TPP.

Procedural notes are included in a box located below the altitude and visibility minimums. For example, a procedural note might indicate, “Circling NA E of RWY 1-19.” Some other notes might concern a local altimeter setting and the resulting change in the minimums. The use of RADAR may also be noted in this section. Additional notes may be found in the plan view.

When a triangle containing a “T”  appears in the notes area, it signifies the airport has nonstandard IFR takeoff minimums. The appropriate section in the front of the TPP would be consulted in this case.

In addition to the COPTER approaches, instrument-equipped helicopters may fly standard approach procedures. The required visibility minimum may be reduced to one-half the published visibility minimum for category A aircraft, but in no case may it be reduced to less than 1/4 mile or 1,200 feet RVR.

A couple of terms are specific to helicopters. **Height above landing (HAL)** means height above a designated helicopter landing area used for helicopter IAPs. **“Point in space approach”** refers to a helicopter IAP to a MAP more than 2,600 feet from an associated helicopter landing area.


### Airport Diagram

The **airport diagram**, located on the bottom right side of the chart, includes many helpful features. IAPs for some of the larger airports devote an entire page to an airport diagram. Information concerning runway orientation, lighting, final approach bearings, airport beacon, and obstacles all serve to guide the pilot in the final phases of flight. See figure 8-15 for a legend of airport diagram features (see also figure 8-7 for an example of an airport diagram).

The diagram shows the runway configuration in solid black, while the taxiways and aprons are shaded gray. Other runway environment features are shown, such as the runway identification, dimensions, magnetic heading, displaced threshold, arresting gear, usable length, and slope.

The airport elevation is indicated in a separate box at the top of the airport diagram box. The **touch down zone elevation (TDZE)**, which is the highest elevation within the first 3,000 feet of the runway, is designated at the approach end of the procedure’s runway.

Beneath the airport diagram is the **time and speed table**. The table provides the distance and the amount of time required to transit the distance from the FAF to the MAP for selected groundspeeds.

The approach lighting systems and the visual approach lights are depicted on the approach chart. White on black symbols  are used for identifying pilot-controlled lighting (PCL). Runway lighting aids are also noted (e.g., REIL, HIRL), as is the runway centerline lighting (RCL). [Figure 8-16]

**Alternate airport:** Designated in an IFR flight plan, provides a suitable destination if a landing at the intended airport becomes inadvisable.

**Height above landing (HAL):** A HAL is a height above a designated helicopter landing area used for helicopter instrument approach procedures.

**Point in space approach:** A type of helicopter instrument approach procedure to a missed approach point more than 2,600 feet from an associated helicopter landing area.

**Airport diagram:** The section of an IAP chart that shows a detailed diagram of the airport including surface features and airport configuration information.

**Touch down zone elevation (TDZE):** The highest elevation in the first 3,000 feet of the landing surface, TDZE is indicated on the IAP chart when straight-in landing minimums are authorized.

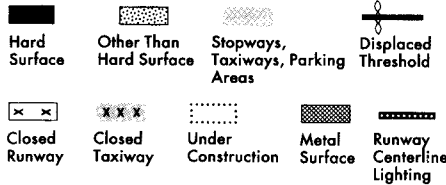
**Time and speed table:** A table depicted on an instrument approach procedure chart that identifies the distance from the FAF to the MAP, and provides the time required to transit that distance based on various ground speeds.

# LEGEND

## INSTRUMENT APPROACH PROCEDURES (CHARTS)

### AIRPORT DIAGRAM/AIRPORT SKETCH

#### Runways



Helicopter Alighting Areas (H, H, H, H, H)  
 Negative Symbols used to identify Copter Procedures landing point (H, H, H, H, H)

Runway TDZ elevation.....TDZE 123  
 ←-0.3% DOWN  
 Runway Slope.....0.8% UP→  
 (shown when runway slope exceeds 0.3%)

**ARRESTING GEAR:** Specific arresting gear systems; e.g., BAK-12, MA-1A etc., shown on airport diagrams, not applicable to Civil Pilots. Military Pilots Refer to Appropriate DOD Publications.

#### NOTE:

Runway Slope measured to midpoint on runways 8000 feet or longer.

U.S. Navy Optical Landing System (OLS) \*OLS\* location is shown because of its height of approximately 7 feet and proximity to edge of runway may create an obstruction for some types of aircraft.

Approach light symbols are shown in the Flight Information Handbook.

Airport diagram scales are variable.

True/magnetic North orientation may vary from diagram to diagram.

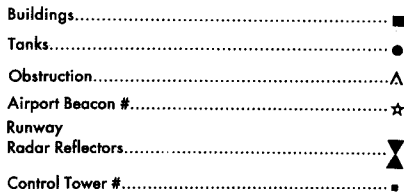
Coordinate values are shown in 1 or ½ minute increments. They are further broken down into 6 second ticks, within each 1 minute increment.

Positional accuracy within ±600 feet unless otherwise noted on the chart.

#### NOTE:

All new and revised airport diagrams are shown referenced to the World Geodetic System (WGS) (noted on appropriate diagram), and may not be compatible with local coordinates published in FLIP. (Foreign Only)

#### REFERENCE FEATURES

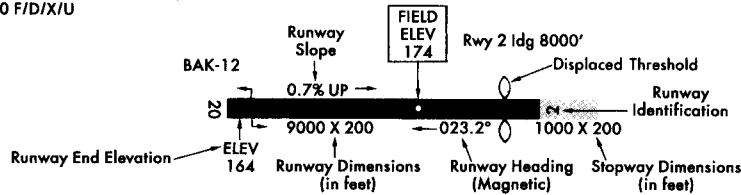


# When Control Tower and Rotating Beacon are co-located, Beacon symbol will be used and further identified as TWR.

Runway length depicted is the physical length of the runway (end-to-end, including displaced thresholds if any) but excluding areas designated as stopways. Where a displaced threshold is shown and/or part of the runway is otherwise not available for landing, an annotation is added to indicate the landing length of the runway; e.g., RWY 13 ldg 5000'.

Runway Weight Bearing Capacity/or PCN Pavement Classification Number is shown as a codified expression.

Refer to the appropriate Supplement/Directory for applicable codes, e.g., RWY 14-32 S75, T185, ST175, TT325 PCN 80 F/D/X/U



#### SCOPE

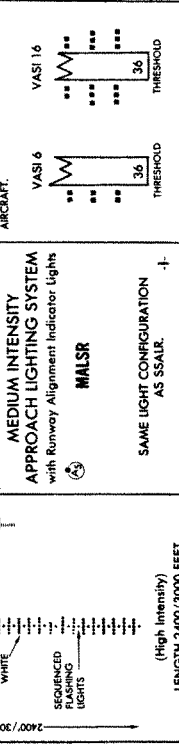
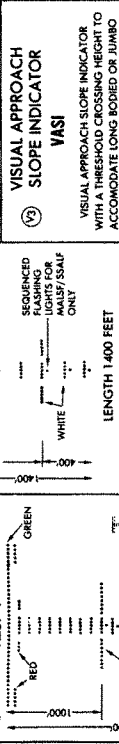
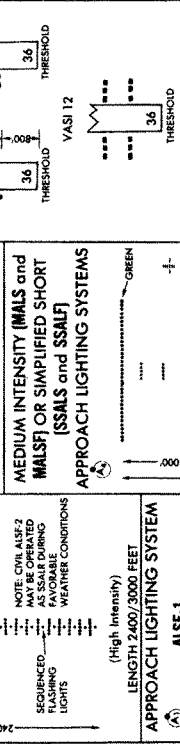
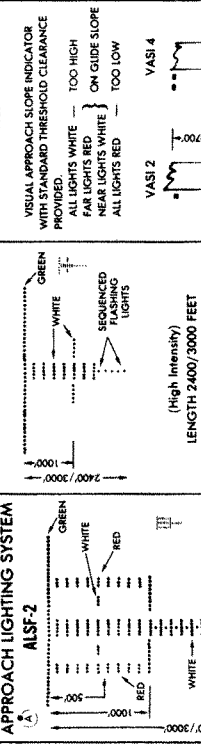
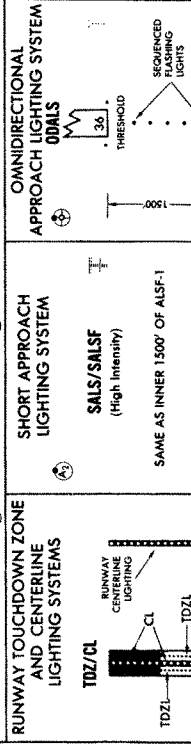
Airport diagrams are specifically designed to assist in the movement of ground traffic at locations with complex runway/taxiway configurations and provide information for updating Computer Based Navigation Systems (I.E., INS, GPS) aboard aircraft. Airport diagrams are not intended to be used for approach and landing or departure operations. For revisions to Airport Diagrams: Consult FAA Order 7910.4B.

Figure 8-15. Airport diagram legend.

INSTRUMENT APPROACH PROCEDURES (CHARTS)  
APPROACH LIGHTING SYSTEM — UNITED STATES

Each approach lighting system indicated on Airport Diagrams will bear a system identification indicated in legend.

A dot "•" portrayed with approach lighting letter identifier indicates sequenced flashing lights (F) installed with the approach lighting system e.g. (A) Negative symbology, e.g. (B) indicates Pilot Controlled Lighting (PCL).



AVAILABILITY OF TDZL/CL will be shown by NOTE in SKETCH e.g. "TDZL/CL Rev 15"

INSTRUMENT APPROACH PROCEDURES (CHARTS)  
APPROACH LIGHTING SYSTEM — UNITED STATES

Each approach lighting system indicated on Airport Diagrams will bear a system identification indicated in legend.

A dot "•" portrayed with approach lighting letter identifier indicates sequenced flashing lights (F) installed with the approach lighting system e.g. (A) Negative symbology, e.g. (B) indicates Pilot Controlled Lighting (PCL).



CAUTION: When viewing the pulsating visual approach slope indicators in the pulsating white or pulsating red sectors, it is possible to mistake this lighting aid for another aircraft or a ground vehicle. Pilots should exercise caution when using this type of system.

Figure 8-16. Approach lighting legend.

## Inoperative Components

Certain procedures can be flown with **inoperative components**. According to the Inoperative Components Table, for example, an ILS approach with a malfunctioning Medium Intensity Approach Lighting System with Runway Alignment Indicator Lights (MALSR = MALS with RAIL) can be flown if the minimum visibility is increased by 1/4 mile. [Figure 8-17] A note in this section might read, “Inoperative Table does not apply to ALS or HIRL Runway 13L.”

## RNAV Instrument Approach Charts

Instrument approach charts are being converted to a charting format similar to the format developed for RNAV IAP. [Figure 8-18] This format avoids unnecessary duplication and proliferation of instrument approach charts. The approach minimums for unaugmented GPS, Wide Area Augmentation System (WAAS), Local Area Augmentation System (LAAS), will be published on the same approach chart as lateral navigation/vertical navigation (LNAV/VNAV). Other types of equipment may be authorized to conduct the approach based on the minima notes in the front of the TPP approach chart books. Approach charts titled “RNAV RWY XX” may be used by aircraft with navigation systems that meet the **required navigational performance (RNP)** values for each segment of the approach.

The chart may contain as many as four lines of approach minimums: **Global landing system (GLS)**; WAAS and LAAS; LNAV/VNAV; LNAV; and circling. LNAV/VNAV is an instrument approach with lateral and vertical guidance with integrity limits similar to **barometric vertical navigation (BARO VNAV)**.

RNAV procedures that incorporate a final approach stepdown fix may be published without vertical navigation, on a separate chart, also titled RNAV. During a transition period when GPS procedures are undergoing revision to a new title, both RNAV and GPS approach charts and formats will be published. ATC clearance for the RNAV procedure will authorize a properly-certificated pilot to utilize any landing minimums for which the aircraft is certified.

The RNAV chart will include formatted information required for quick pilot or flightcrew reference located at the top of the chart. This portion of the chart was developed based on a

**Inoperative components:** Higher minimums are prescribed when the specified visual aids are not functioning; this information is listed in the Inoperative Components Table found in the Terminal Procedures Publications.

**Required navigational performance (RNP):** Navigational performance necessary to operate in a given airspace or perform a particular procedure.

study by the Department of Transportation (DOT), Volpe National Transportation Systems Center.

Chart terminology will change slightly to support the new procedure types:

1. DA replaces the term DH. DA conforms to the international convention where altitudes relate to MSL and heights relate to AGL. DA will eventually be published for other types of IAPs with vertical guidance, as well. DA indicates to the pilot that the published descent profile is flown to the DA (MSL), where a missed approach will be initiated if visual references for landing are not established. Obstacle clearance is provided to allow a momentary descent below DA while transitioning from the final approach to the missed approach. The aircraft is expected to follow the missed approach instructions while continuing along the published final approach course to at least the published runway threshold waypoint or MAP (if not at the threshold) before executing any turns.
2. MDA will continue to be used for the LNAV-only and circling procedures.
3. Threshold crossing height (TCH) has been traditionally used in precision approaches as the height of the glide slope above threshold. With publication of LNAV/VNAV minimums and RNAV descent angles, including graphically depicted descent profiles, TCH also applies to the height of the “descent angle,” or glidepath, at the threshold. Unless otherwise required for larger type aircraft which may be using the IAP, the typical TCH will be 30 to 50 feet.

The minima format changes slightly:

1. Each line of minima on the RNAV IAP will be titled to reflect the RNAV system applicable (e.g., GLS, LNAV/VNAV, and LNAV.) Circling minima will also be provided.
2. The minima title box will also indicate the nature of the minimum altitude for the IAP. For example: DA will be published next to the minima line title for minimums supporting vertical guidance, and MDA will be published where the minima line supports only lateral guidance. During an approach where an MDA is used, descent below MDA is not authorized.

**Global Landing System (GLS):** Global Navigation Satellite System (GNSS) that includes WAAS and/or LAAS.

**Barometric vertical navigation (BARO VNAV):** A navigational system which presents computed vertical guidance to the pilot referenced to a specific vertical path angle (VPA) and is based on barometric altitude.

# INOP COMPONENTS

## INOPERATIVE COMPONENTS OR VISUAL AIDS TABLE

Landing minimums published on instrument approach procedure charts are based upon full operation of all components and visual aids associated with the particular instrument approach chart being used. Higher minimums are required with inoperative components or visual aids as indicated below. If more than one component is inoperative, each minimum is raised to the highest minimum required by any single component that is inoperative. ILS glide slope inoperative minimums are published on instrument approach charts as localizer minimums. This table may be amended by notes on the approach chart. Such notes apply only to the particular approach category(ies) as stated. See legend page for description of components indicated below.

(1) ILS, MLS, and PAR

Inoperative Component or Aid	Approach Category	Increase Visibility
ALSF 1 & 2, MALSR, & SSALR	ABCD	¼ mile

(2) ILS with visibility minimum of 1,800 RVR.

ALSF 1 & 2, MALSR, & SSALR	ABCD	To 4000 RVR
TDZI RCLS	ABCD	To 2400 RVR
RVR	ABCD	To ½ mile

(3) VOR, VOR/DME, VORTAC, VOR (TAC), VOR/DME (TAC), LOC, LOC/DME, LDA, LDA/DME, SDF, SDF/DME, GPS, RNAV, and ASR

Inoperative Visual Aid	Approach Category	Increase Visibility
ALSF 1 & 2, MALSR, & SSALR	ABCD	½ mile
SSALS, MALS, & ODALS	ABC	¼ mile

(4) NDB

ALSF 1 & 2, MALSR & SSALR	C	½ mile
MALS, SSALS, ODALS	ABD	¼ mile
	ABC	¼ mile

### CORRECTIONS, COMMENTS AND/OR PROCUREMENT

FOR CHARTING  
ERRORS CONTACT:

National Ocean Service/NOAA  
N/ACC1, SSMC-4, Sto. #2335  
1305 East-West Highway  
Silver Spring, MD 20910-3281  
Telephone Toll-Free (800) 626-3677  
Internet/E-Mail: [Aerochart@NOAA.GOV](mailto:Aerochart@NOAA.GOV)

FOR CHANGES, ADDITIONS, OR  
RECOMMENDATIONS ON  
PROCEDURAL ASPECTS:

Contact Federal Aviation Administration, ATA 110  
800 Independence Avenue, S.W.  
Washington, D.C. 20591  
Telephone Toll-Free (800) 457-6656

TO PURCHASE  
CHARTS CONTACT:

National Ocean Service  
NOAA, N/ACC3  
Distribution Division  
Riverdale, MD 20737  
Telephone (800) 638-8972

Requests for the creation or revisions to Airport Diagrams should be in accordance with FAA Order 7910.4B.

Figure 8-17. IAP inoperative components table.



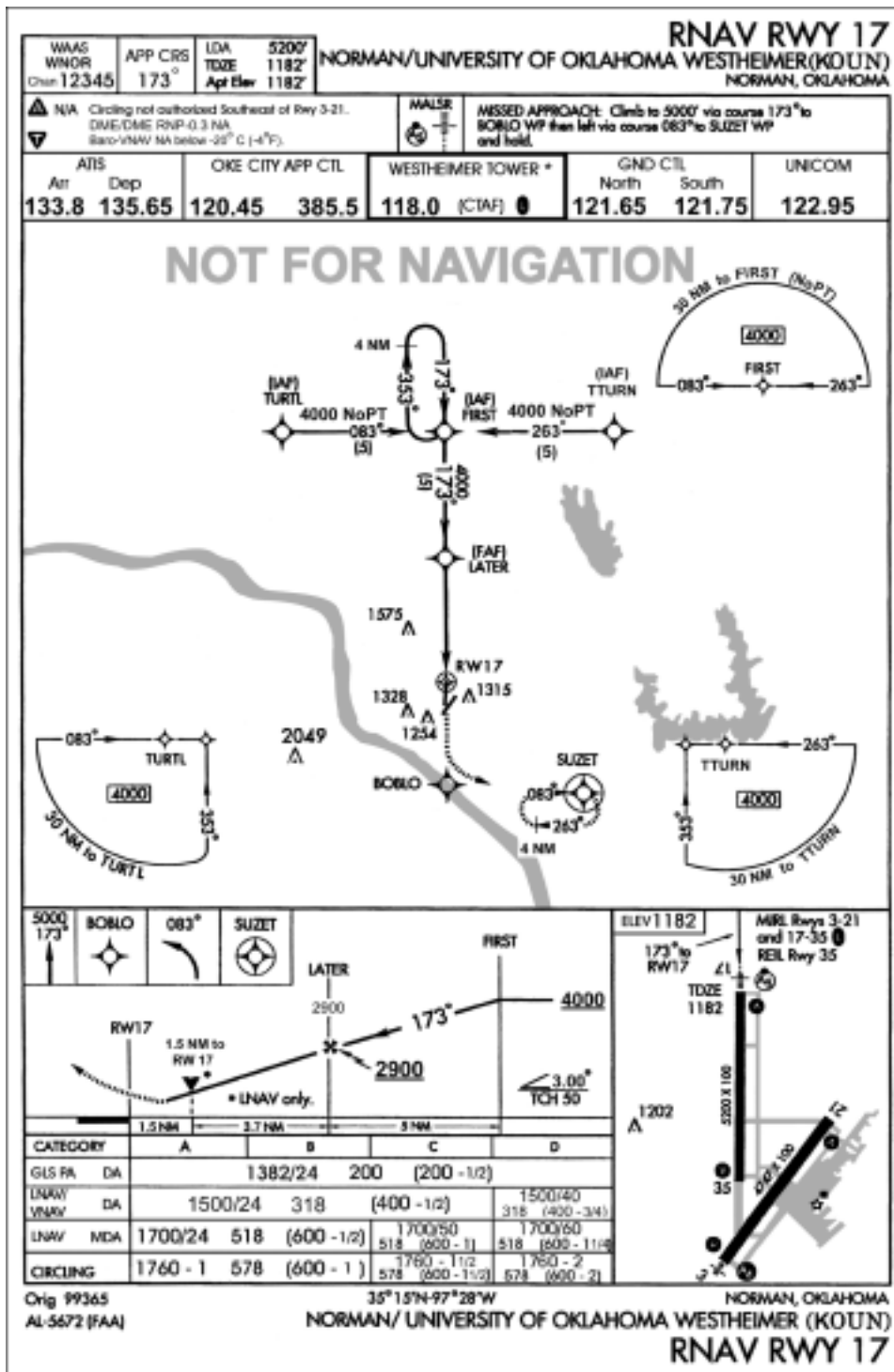


Figure 8-18. RNAV Approach Chart.

3. Where two or more systems share the same minima, each line of minima will be displayed separately.

For more information concerning government charts, the NACO can be contacted by telephone, or via their internet address at:

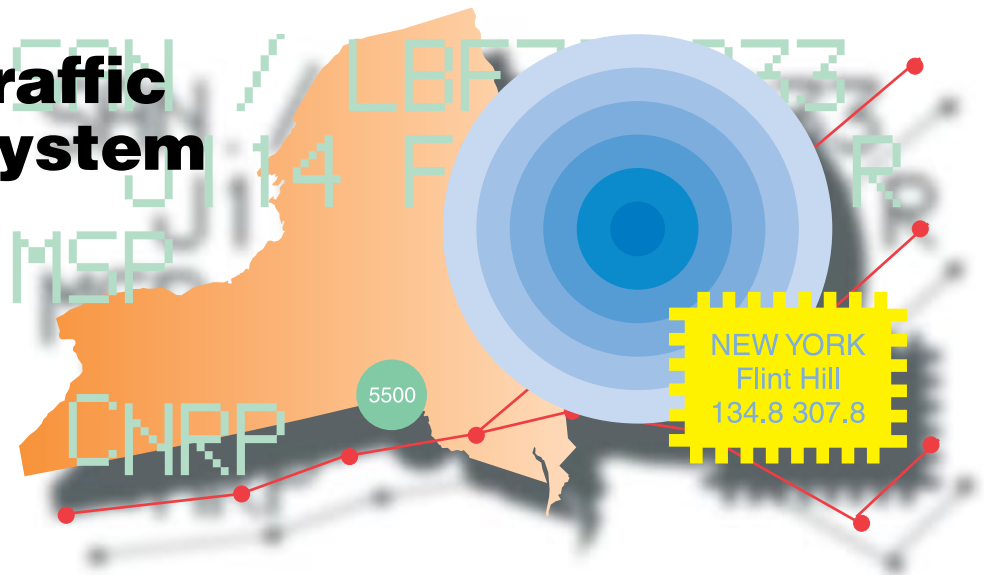
The following chart symbology will change slightly: [Figure 8-18]

1. Descent profile
2. VDP
3. Missed approach symbology
4. Waypoints

National Aeronautical Charting Office  
Telephone 800-626-3677  
<http://acc.nos.noaa.gov/>



# The Air Traffic Control System



## Introduction

This chapter will cover the communication equipment, communication procedures, and air traffic control (ATC) facilities and services available for a flight under instrument flight rules (IFR) in the National Airspace System (NAS).

## Communication Equipment

### Navigation/Communication (NAV/COM) Equipment

Civilian pilots communicate with ATC on frequencies in the very high frequency (VHF) range between 118.000 and 136.975 MHz. To derive full benefit from the ATC system, radios capable of 25 kHz spacing are required (e.g., 134.500, 134.575, 134.600, etc.). If ATC assigns a frequency that cannot be selected on your radio, ask for an alternative frequency.

Figure 9-1 illustrates a typical radio panel installation, consisting of a communications transceiver on the left and a navigational receiver on the right. Many radios allow the pilot to have one or more frequencies stored in memory and one frequency active for transmitting and receiving (called **simplex** operation). It is possible to communicate with some automated flight service stations (AFSS) by transmitting on 122.1 MHz (selected on the communication radio) and receiving on a VHF omnidirectional range (VOR) frequency (selected on the navigation radio). This is called **duplex** operation.

**Simplex:** Transmitting and receiving on the same frequency.

**Duplex:** Transmitting on one frequency and receiving on a separate frequency.

An audio panel allows you to adjust the volume of the selected receiver(s) and to select the desired transmitter. [Figure 9-2] The audio panel has two positions for receiver selection, cabin speaker and headphone (some units might have a center “off” position). Use of a hand-held microphone and the cabin speaker introduces the distraction of reaching for and hanging up the microphone. A headset with a boom microphone is recommended for clear communications. Position the microphone close to your lips because ambient cockpit noise may interfere with the controller understanding your transmissions. Headphones will deliver the received signal directly to your ears; therefore, ambient noise does not interfere with your ability to understand the transmission. [Figure 9-3]

Switching the transmitter selector between COM1 and COM2 changes both the transmitter and receiver frequencies. It should be necessary to select a receiver, communication or navigation, only when you want to monitor one communications frequency while communicating on another. One example is listening to automatic terminal information service (ATIS) on one receiver while communicating with ATC on the other. Monitoring a navigation receiver to check for proper identification is another reason to use the switch panel.

Most audio switch panels also include a marker beacon receiver; all marker beacons transmit on 75 MHz, so there is no frequency selector.



**Figure 9-1.** Typical NAV/COM installation.



**Figure 9-2.** Audio panel.



**Figure 9-3.** Boom microphone, headset, and push-to-talk switch.

Figure 9-4 illustrates an increasingly popular form of **NAV/COM** radio; it contains a global positioning system (GPS) receiver and a communications transceiver. Using its navigational capability, this unit can determine when your flight crosses an airspace boundary or fix and can automatically select the appropriate communications frequency for that location in the communications radio.

### **Radar and Transponders**

ATC **radars** have a limited ability to display primary returns, which is energy reflected from an aircraft's metallic structure. Their ability to display secondary returns (transponder replies to ground interrogation signals) makes possible the many advantages of automation.

**NAV/COM:** Combined communication and navigation radio.

**Radar:** Radio Detection And Ranging.

**Transponder code:** One of 4,096 four-digit discrete codes ATC will assign to distinguish between aircraft.



**Figure 9-4.** Combination GPS-Com unit.

A transponder is a radar beacon transmitter/receiver installed in the instrument panel. ATC beacon transmitters send out interrogation signals continuously as the radar antenna rotates. When an interrogation is received by your transponder, a coded reply is sent to the ground station where it is displayed on the controller's scope. A "Reply" light on your transponder panel flickers every time you receive and reply to a radar interrogation. **Transponder codes** are assigned by ATC.

When a controller asks you to "**ident**" and you push the ident button, your return on the controller's scope is intensified for precise identification of your flight. When requested, briefly push the ident button to activate this feature. It is good practice to verbally confirm you have changed codes or pushed the ident button.

### *Mode C (Altitude Reporting)*

Primary radar returns indicate only range and bearing from the radar antenna to the target; secondary radar returns can display altitude **Mode C** on the control scope if the aircraft is equipped with an encoding altimeter or blind encoder. In either case, when the transponder's function switch is in the ALT position the aircraft's **pressure altitude** is sent to the controller. Adjusting the altimeter's **Kollsman window** has no effect on the altitude read by the controller.

Transponders must be ON at all times when operating in controlled airspace; altitude reporting is required by regulation in Class B and Class C airspace and inside of a 30-mile circle surrounding the primary airport in Class B airspace. Altitude reporting should also be ON at all times.

**Ident:** Push the button on the transponder to identify your return on the controller's scope.

**Mode C:** Altitude reporting transponder mode.

**Pressure altitude:** Altitude above the standard 29.92" Hg plane.

**Kollsman window:** Adjustment for altimeter setting.

## Communication Procedures

Clarity in communication is essential for a safe instrument flight. This requires pilots and controllers to use terms that are understood by both — the *Pilot/Controller Glossary* in the *Aeronautical Information Manual* (AIM) is the best source of terms and definitions. The AIM is revised twice a year and new definitions are added, so the Glossary should be reviewed frequently. Because clearances and instructions are comprised largely of letters and numbers, a phonetic pronunciation guide has been developed for both. [Figure 9-5]

Air traffic controllers must follow the guidance of the *Air Traffic Control Manual* when communicating with pilots. The manual presents the controller with different situations and prescribes precise terminology that must be used. This is advantageous for pilots, because once they have recognized a pattern or format they can expect future controller transmissions to follow that format. Controllers are faced with a wide variety of communication styles based on pilot experience, proficiency, and professionalism.

Pilots should study the examples in the AIM, listen to other pilots communicate, and apply the lessons learned to their own communications with ATC. Pilots should ask for clarification of a clearance or instruction. If necessary, use plain English to ensure understanding, and expect the controller to reply in the same way. A safe instrument flight is the result of cooperation between controller and pilot.

## Communication Facilities

The controller's primary responsibility is separation of aircraft operating under IFR. This is accomplished with ATC facilities which include the AFSS, airport traffic control tower (ATCT), terminal radar approach control (TRACON), and air route traffic control center (ARTCC).

### Automated Flight Service Stations (AFSS)

Your first contact with ATC will probably be through AFSS, either by radio or telephone. AFSS's provide pilot briefings, receives and processes flight plans, relays ATC clearances, originates Notices to Airmen (NOTAMs), and broadcasts aviation weather. Some facilities provide **En Route Flight Advisory Service (EFAS)**, take weather observations, and advise United States (U.S.) Customs and Immigration of international flights.

**En Route Flight Advisory Service (EFAS):** An en route weather-only AFSS service.

Character	Morse Code	Telephony	Phonic (Pronunciation)
A	• —	Alfa	(AL-FAH)
B	— •••	Bravo	(BRAH-VOH)
C	— • — •	Charlie	(CHAR-LEE) or (SHAR-LEE)
D	— ••	Delta	(DELL-TAH)
E	•	Echo	(ECK-OH)
F	•• — •	Foxtrot	(FOKS-TROT)
G	— — •	Golf	(GOLF)
H	••••	Hotel	(HOH-TEL)
I	••	India	(IN-DEE-AH)
J	• — — —	Juliett	(JEW-LEE-ETT)
K	— • —	Kilo	(KEY-LOH)
L	• — ••	Lima	(LEE-MAH)
M	— —	Mike	(MIKE)
N	— •	November	(NO-VEH-BER)
O	— — —	Oscar	(OSS-CAH)
P	• — — •	Papa	(PAH-PAH)
Q	— — • —	Quebec	(KEH-BECK)
R	• — •	Romeo	(ROW-ME-OH)
S	•••	Sierra	(SEE-AIR-RAH)
T	— —	Tango	(TANG-GO)
U	•• —	Uniform	(YOU-NEE-FORM) or (OO-NEE-FORM)
V	••• —	Victor	(VIK-TAH)
W	• — —	Whiskey	(WISS-KEY)
X	— •• —	Xray	(ECKS-RAY)
Y	— • — —	Yankee	(YANG-KEY)
Z	— — ••	Zulu	(ZOO-LOO)
1	• — — — —	One	(WUN)
2	•• — — —	Two	(TOO)
3	••• — —	Three	(TREE)
4	•••• —	Four	(FOW-ER)
5	•••••	Five	(FIFE)
6	— ••••	Six	(SIX)
7	— — •••	Seven	(SEV-EN)
8	— — — ••	Eight	(AIT)
9	— — — — •	Nine	(NIN-ER)
0	— — — — —	Zero	(ZEE-RO)

Figure 9-5. Phonetic pronunciation guide.

Telephone contact with Flight Service can be obtained by dialing 1-800-WX-BRIEF anywhere in the United States—you will be connected to the nearest AFSS based on the area code from which you are calling. There are a variety of methods of making radio contact: direct transmission, remote communications outlets (RCOs), ground communication outlets (GCOs), and by using duplex transmissions, through navigational aids (NAVAIDs). The best source of information on frequency usage is the *Airport/Facility Directory (A/FD)*, and the legend panel on sectional charts also contains contact information.

The briefer will send your flight plan to the host computer at the ARTCC (Center). After processing your flight plan, the computer will send **flight strips** to the tower, to the radar facility that will handle your departure route, and to the Center controller whose sector you will first enter. Figure 9-6 shows a typical strip. These strips will be delivered approximately 30 minutes prior to your proposed departure time. Strips will be delivered to en route facilities 30 minutes before you are expected to enter their airspace. If you fail to open your flight plan, it will “time out” 2 hours after your proposed departure time.

When departing an airport in Class G airspace, you will receive your IFR clearance from the AFSS by radio or telephone. It will contain either a “**clearance void**” time, in which case you must be airborne prior to that time, or a “release” time—you should not be airborne prior to release

time. You can help the controller by stating how soon you expect to be airborne. If your void time is, for example, 10 minutes past the hour and you are airborne at exactly 10 minutes past the hour, your clearance is void—you must be airborne prior to the void time. You may ask for a specific void time when filing your flight plan.

### Air Traffic Control Towers

Several controllers in the tower cab will be involved in handling your instrument flight. Where there is a dedicated clearance delivery position, that frequency will be found in the A/FD and on the instrument approach chart for the departure airport. Where there is no clearance delivery position, the ground controller will perform this function. At the busiest airports, pre-taxi clearance is required; the frequency for pre-taxi clearance can be found in the A/FD. Taxi clearance should be requested not more than 10 minutes before proposed taxi time.

It is recommended that you read your IFR clearance back to the clearance delivery controller. Instrument clearances can be overwhelming if you try to copy them verbatim, but they follow a format that allows you to be prepared when you say “Ready to copy.” The format is: Clearance limit (usually the destination airport); Route, including any departure procedure; initial Altitude; Frequency (for departure control); and Transponder code. With the exception of the transponder code, you will know most of these items before engine start. One technique for clearance copying is writing C-R-A-F-T.

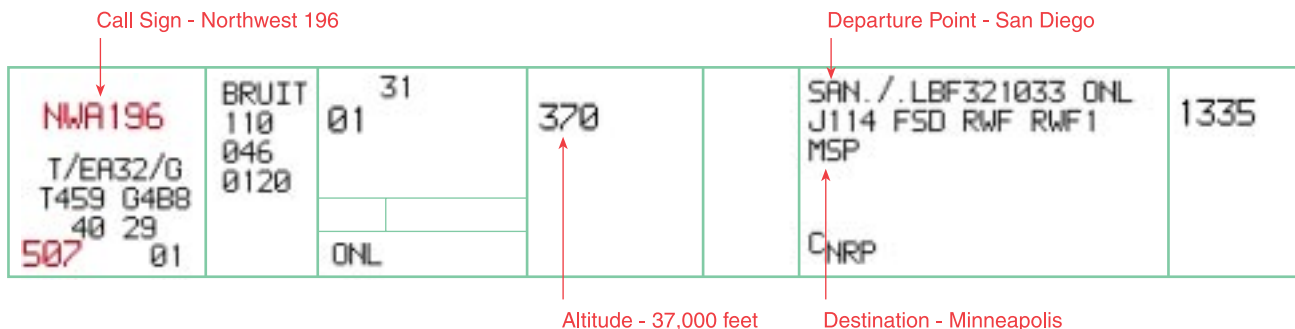


Figure 9-6. Flight strip.

**Flight strips:** Paper strips containing instrument flight information.

**Clearance void time:** Used by ATC to advise an aircraft that the departure clearance is automatically canceled if takeoff is not made prior to a specified time. The pilot must obtain a new clearance or cancel the IFR flight plan if not off by the specified time.

### Memory aid for IFR clearance format:

- C** learance limit
- R** oute (including DP, if any)
- A** ltitude
- F** requency
- T** ransponder code



Assume you have filed an IFR flight plan from Seattle, Washington to Sacramento, California via V-23 at 7,000 feet. You note traffic is taking off to the north from Seattle-Tacoma (Sea-Tac) airport and, by monitoring the clearance delivery frequency, you note the departure procedure being assigned to southbound flights. Your clearance limit will be the destination airport, so you can write “SAC” after the letter C. Write “SEATTLE TWO – V23” after R for Route, because you heard departure control issue this departure to other flights (you could also call the tower on the telephone to ask what departure is in use). Write “7” after the A, the departure control frequency printed on the approach charts for Sea-Tac after F, and leave the space after T blank—the transponder code is generated by computer and can seldom be determined in advance. Now call clearance delivery and report ready to copy.

As the controller reads the clearance, check it against what you have already written down; if there is a change, draw a line through that item and write in the changed item. Chances are the changes will be minimal, and you will have “copied” most of your clearance before keying the microphone. Still, it is worthwhile to develop your own clearance shorthand to cut down on the verbiage that must be copied (*see* appendix 1).

You are required to have either the text or a graphic representation of a departure procedure (DP) (if one is available), and should review it before you accept your clearance. This is another reason to find out ahead of time which DP is in use. If the DP includes an altitude or a departure control frequency, those items will not be included in the clearance delivered to you from the tower cab.

The last clearance received supersedes all previous clearances. For instance, if the DP says “Climb and maintain 2,000 feet, expect higher in 6 miles” and upon contacting the departure controller you hear “Climb and maintain 8,000 feet,” the 2,000-foot restriction has been canceled. This rule applies in both terminal and Center airspace.

If you report ready to copy your IFR clearance before the strip has been received from the Center computer, you will be advised “**clearance on request**” and the controller will call you when it has been received. Use this time for taxi and pretakeoff checks.

The “local” controller is responsible for operations in the **Class D airspace** and on the active runways. At some towers, designated as IFR towers, the local controller has **vectoring** authority. At visual flight rules (VFR) towers, the local controller accepts inbound IFR flights from the terminal radar facility and cannot provide vectors. The local controller also coordinates flights in the local area with radar controllers. Although Class D airspace normally extends 2,500 feet above field elevation, towers frequently release the top 500 feet to the radar controllers to facilitate overflights. Accordingly, when your flight is vectored over an airport at an altitude that appears to enter the tower controller’s airspace, there is no need for you to contact the tower controller—all coordination is handled by ATC.

The departure radar controller may be in the same building as the control tower, but it is more likely that the departure radar position is remotely located. The tower controller will not issue a takeoff clearance until the departure controller issues a release.

### **Terminal Radar Approach Control (TRACON)**

TRACONS are considered terminal facilities because they provide the link between the departure airport and the en route structure of the NAS. Terminal airspace normally extends 30 nautical miles (NM) from the facility, with a vertical extent of 10,000 feet; however, dimensions vary widely. Class B and Class C airspace dimensions are provided on aeronautical charts. At terminal radar facilities the airspace is divided into sectors, each with one or more controllers, and each sector is assigned a discrete radio frequency. All terminal facilities are approach controls, and should be addressed as “Approach” except when directed to do otherwise (“Contact departure on 120.4”).

Terminal radar antennas are located on or adjacent to the airport. Figure 9-7 shows a typical configuration. Terminal controllers can assign altitudes lower than published procedural altitudes called **minimum vectoring altitudes (MVAs)**. These altitudes are not published and accessible to pilots, but are displayed at the controller’s position, as shown in figure 9-8. However, if you are assigned an altitude that seems to be too low, query the controller before descending.

**Clearance on request:** Clearance has not been received.

**Class D airspace:** Airspace controlled by an operating control tower.

**Vectoring:** Navigational guidance by assigning headings.

**Minimum vectoring altitude (MVA):** An IFR altitude, lower than the minimum en route altitude (MEA), that provides terrain and obstacle clearance.

### **Terrain Clearance Responsibility**

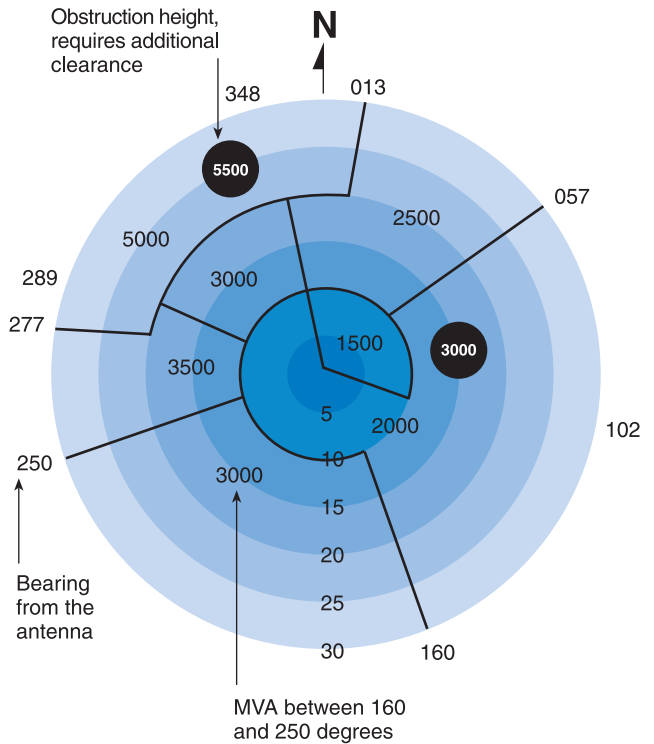
**Terrain clearance responsibility is yours as pilot in command, until you reach the controller’s MVA; but even then, if the altitude assigned seems too low, query the controller before descending.**



**Figure 9-7.** Combined radar and beacon antenna.

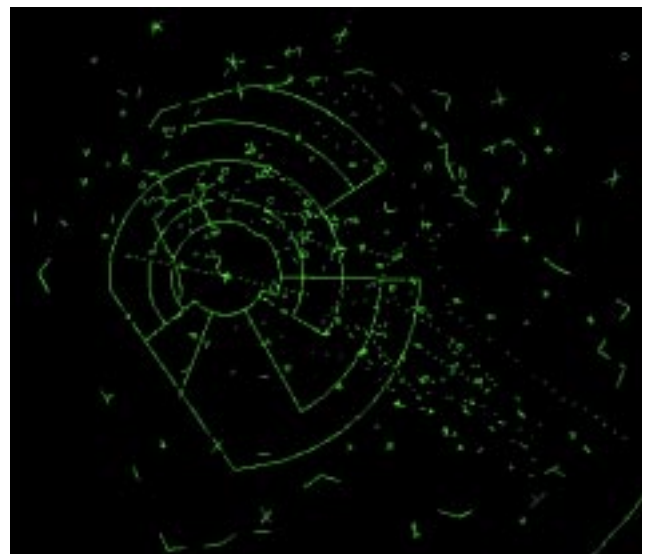
When you receive and accept your clearance and report ready for takeoff, a controller in the tower contacts the TRACON for a release—you will not be released until the departure controller can fit your flight into the departure flow. You may have to hold for release. When you receive takeoff clearance, the departure controller is aware of your flight and is waiting for your call. All of the information the controller needs is on the departure strip or the computer screen, so you need not repeat any portion of your clearance to that controller; simply establish contact with the facility when instructed to do so by the tower controller. The terminal facility computer will pick up your transponder and initiate tracking as soon as it detects the assigned code; for this reason, the transponder should remain on standby until takeoff clearance has been received.

Your aircraft will appear on the controller's radar as a target with an associated data block that moves as your aircraft moves through the airspace. The data block includes aircraft identification, aircraft type, altitude, and airspeed.



**Figure 9-8.** Minimum Vectoring Altitude Chart.

A TRACON controller uses Airport Surveillance Radar (ASR) to detect primary targets and Automated Radar Terminal Systems (ARTS) to receive transponder signals; the two are combined on the controller's scope. [Figure 9-9]

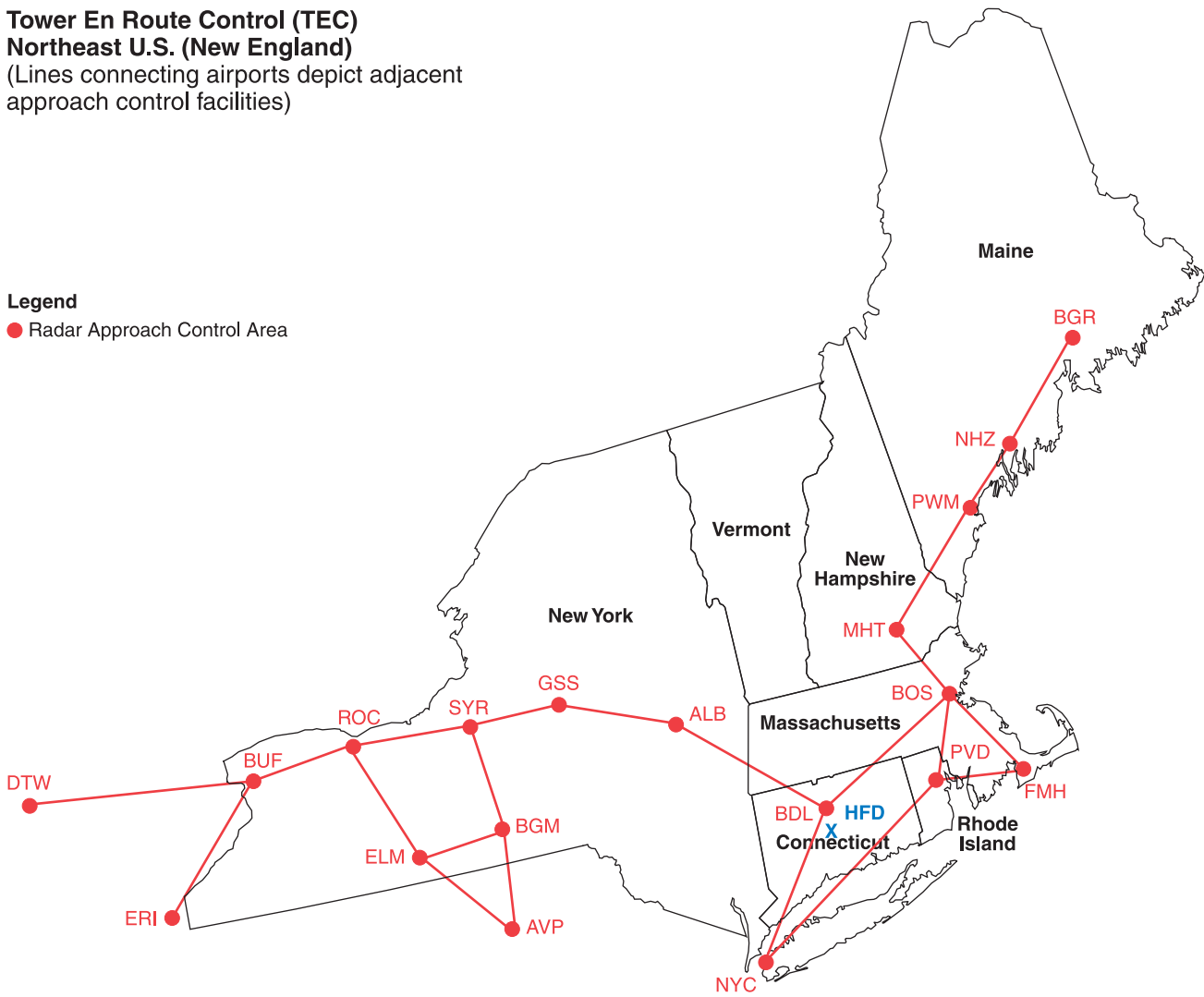


**Figure 9-9.** What the approach controller sees.

**Tower En Route Control (TEC)  
 Northeast U.S. (New England)**  
 (Lines connecting airports depict adjacent  
 approach control facilities)

**Legend**

● Radar Approach Control Area



New York/Kennedy	.....	SAX V249 SBJ V30 ETX (Non jet/Non turboprop)	8000	Allentown
	.....	DIXIE V229 ACY (Props only)	6000	Atlantic City
	.....	DIXIE V1 HOWIE (Jets only)	8000	Atlantic City
	.....	DIXIE V1 V308 OTT (Props only)	6000	Andrews AFB
	.....	DIXIE V16 ENO V268 SWANN (Props only)	6000	Baltimore
	.....	COL	2000	Belmar
	.....	BDR MAD V475 V188 TMU	9000	Block Island
	.....	BDR V229 HFD V3 WOONS	9000	Boston
	.....	BDR V229 HFD HFD053 DREEM	9000	Boston (North)
	.....	BDR BDR014 JUDDS V419 BRISS	9000	Bradley
	.....	BDR BDR014 JUDDS V419 BRISS (Jets only)	10000	Bradley

**Figure 9-10.** A portion of the New York area Tower En Route list. (From the A/FD.)

At facilities with ASR-3 equipment, radar returns from precipitation are not displayed as varying levels of intensity, and controllers must rely on pilot reports and experience to provide weather avoidance information. With ASR-9 equipment, the controller can select up to six levels of intensity. Level 1 precipitation does not require avoidance tactics, but the presence of levels 2 or 3 should cause pilots to investigate further. The returns from higher levels of intensity may obscure aircraft data blocks, and controllers may select the higher levels only on pilot request. When you are uncertain about the weather ahead, ask the controller if the facility can display intensity levels—pilots of small aircraft should avoid intensity levels 3 or higher.

### **Tower En Route Control (TEC)**

At many locations, instrument flights can be conducted entirely in terminal airspace. These TEC routes are generally for aircraft operating below 10,000 feet, and they can be found in the A/FD. Pilots desiring to use TEC should include that designation in the remarks section of the flight plan.

Pilots are not limited to the major airports at the city pairs listed in the A/FD. For example, a tower en route flight from an airport in New York (NYC) airspace could terminate at any airport within approximately 30 miles of Bradley International (BDL) airspace, such as Hartford (HFD). [Figure 9-10]

A valuable service provided by the automated radar equipment at terminal radar facilities is the Minimum Safe Altitude Warnings (MSAW). This equipment predicts your aircraft's position in 2 minutes based on present path of flight—the controller will issue a safety alert if the projected path will encounter terrain or an obstruction. An unusually rapid descent rate on a **nonprecision approach** can trigger such an alert.

### **Air Route Traffic Control Centers (ARTCC)**

Air route traffic control center facilities are responsible for maintaining separation between IFR flights in the en route structure. Center radars (Air Route Surveillance Radar) acquire and track transponder returns using the same basic technology as terminal radars. [Figure 9-11]

**Nonprecision approach:** An instrument approach without vertical guidance.



**Figure 9-11.** Center radar displays.

Earlier Center radars display weather as an area of slashes (light precipitation) and H's (moderate rainfall), as illustrated in figure 9-12. Because the controller cannot detect higher levels of precipitation, pilots should be wary of areas showing moderate rainfall. Newer radar displays show weather as three levels of blue. Controllers can select the level of weather to be displayed. Weather displays of higher levels of intensity can make it difficult for controllers to see aircraft data blocks, so pilots should not expect ATC to keep weather displayed continuously.

Center airspace is divided into sectors in the same manner as terminal airspace; additionally, most Center airspace is divided by altitudes into high and low sectors. Each sector has a dedicated team of controllers and a selection of radio frequencies, because each Center has a network of remote transmitter/receiver sites. You will find all Center frequencies in the back of the A/FD in the format shown in figure 9-13; they are also found on en route charts.

Each ARTCC's area of responsibility covers several states; as you fly from the vicinity of one remote communication site toward another, expect the same controller to talk to you on different frequencies.

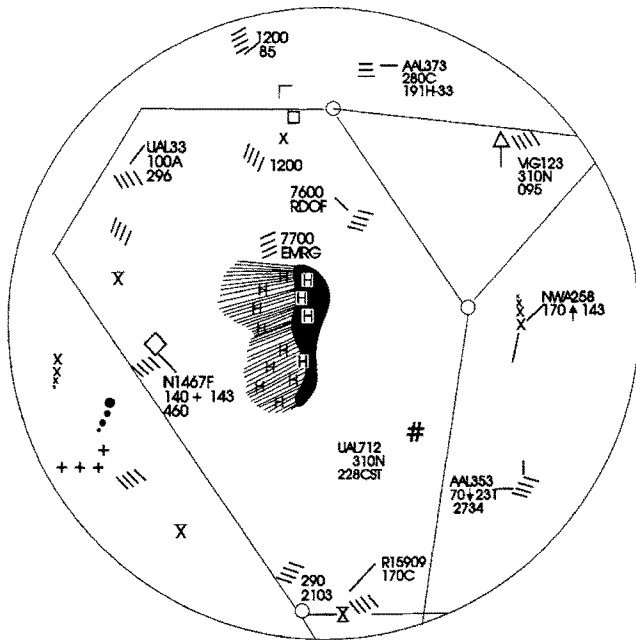


Figure 9-12. A Center controller's scope.

® FORT WORTH CENTER	134.4	H-2-3-4, L-4-6-13-14-15-17	(KZFW)
Abilene	-134.25	127.45	
Ardmore	-132.975	128.1	
Big Spring	-133.7		
Blue Ridge	-127.6	124.87	
Brownwood	-127.45		
Clinton-Sherman	-132.45	128.4	126.3
Cumby	-132.85	132.02	126.57
Dublin	-135.375	128.32	127.15
El Dorado	-133.875	128.2	
Frankston	-135.25	134.025	
Gainsville	-134.15	126.77	
Hobbs	-133.1		
Keller	-135.275	134.15	133.25
Lubbock	-133.35	127.7	126.45
Marshall	-135.1	128.125	
McAlester	-135.45	132.2	
Midland (Site A)	-133.1	132.075	
Mineral Wells	-135.6	127.0	
Monroe	-135.1		
Oklahoma City	-133.9	132.45	
Paducah	-134.55	133.5	133.35
Paris	-127.6		
Plainview	-126.45		
San Angelo	-132.075	126.15	
Scurry	-135.75	126.725	
Shreveport	-135.1	132.275	
Texarkana	-134.475	133.95	126.57
Tyler	-135.25	134.025	
Waco	-133.3		
Wichita Falls (Site Nr1)	-134.55	132.925	
Wichita Falls (Site Nr2)	-133.5	127.95	

Figure 9-13. Center symbology.

## Center Approach/Departure Control

The majority of airports with instrument approaches do not lie within terminal radar airspace, and when operating to or from these airports you will communicate directly with the Center controller. If you are departing a tower-controlled airport, the tower controller will provide instructions for contacting the appropriate Center controller. When you depart an airport without an operating control tower, your clearance will include instructions such as "Upon entering controlled airspace, contact Houston Center on 126.5." You are responsible for terrain clearance until you reach the controller's MVA. Simply hearing "Radar contact" is not sufficient to relieve you of this responsibility.

If obstacles in the departure path require a steeper-than-standard climb gradient (200 feet per NM), you should be so advised by the controller. However, you should check the departure airport listing in the A/FD to determine if there are trees or wires in the departure path just to be sure; when in doubt, ask the controller for the required climb gradient.

A common clearance in these situations is "When able, proceed direct to the Astoria VOR..." The words "when able" mean to proceed when you can do so while maintaining terrain and obstruction clearance—they do not mean to proceed as soon as a signal suitable for navigation is received from the NAVAID. Using the standard climb gradient, you will be 2 miles from the departure end of the runway before it is safe to turn (400 feet above ground level (AGL)). When a Center controller issues a heading, a direct route, or says "direct when able," the controller becomes responsible for terrain and obstruction clearance.

Another common Center clearance is "Leaving (altitude) fly (heading) or proceed direct when able." This keeps the terrain/obstruction clearance responsibility in the cockpit until above the minimum IFR altitude. A controller cannot issue an IFR clearance until you are above the minimum IFR altitude unless you are able to climb in VFR conditions.

On a Center controller's scope, 1 NM is about 1/28 of an inch; when a Center controller is providing Approach/Departure control services at an airport many miles from the radar antenna, estimating headings and distances is very difficult. Controllers providing vectors to final must set the range on

their scopes to not more than 125 NM; this is to provide the greatest possible accuracy for intercept headings. Accordingly, at locations more distant from a Center radar antenna, pilots should expect a minimum of vectoring.

## Control Sequence

The IFR system is flexible and accommodating if you have done your homework, have as many frequencies as possible written down before they are needed, and have an alternate in mind if your flight cannot be completed as planned. Familiarize yourself with all the facilities and services available on your route of flight. [Figure 9-14] Always know where the nearest VFR conditions can be found, and be prepared to head in that direction if your situation deteriorates.

A typical IFR flight, with departure and arrival at airports with control towers, would use the ATC facilities and services in the following sequence:

1. AFSS: Obtain a weather briefing for your departure, destination and alternate airports, and en route conditions, then file your flight plan by calling 1-800-WX-BRIEF.
2. ATIS: Preflight complete, listen for present conditions and the approach in use.
3. Clearance Delivery: Prior to taxiing, obtain your departure clearance.
4. Ground Control: Noting that you are IFR, receive taxi instructions.
5. Tower: Pretakeoff checks complete, receive clearance to takeoff.
6. Departure Control: Once your transponder “tags up” with the ARTS, the tower controller will instruct you to contact Departure to establish radar contact.
7. ARTCC: After departing the departure controller’s airspace, you will be handed off to Center who will coordinate your flight while en route. You may be in contact with multiple ARTCC facilities; they will coordinate the hand-offs.
8. EFAS/HIWAS: Coordinate with ATC before leaving their frequency to obtain inflight weather information.
9. ATIS: Coordinate with ATC before leaving their frequency to obtain ATIS information.
10. Approach Control: Center will hand you off to approach control where you will receive additional information and clearances.
11. Tower: Once cleared for the approach, you will be instructed to contact tower control; your flight plan will be canceled by the tower controller upon landing.

A typical IFR flight, with departure and arrival at airports without operating control towers, would use the ATC facilities and services in the following sequence:

1. AFSS: Obtain a weather briefing for your departure, destination and alternate airports, and en route conditions, then file your flight plan by calling 1-800-WX-BRIEF. Provide the latitude/longitude description for small airports to ensure that Center is able to locate your departure and arrival locations.
2. AFSS or UNICOM: ATC clearances can be filed and received on the UNICOM frequency if the licensee has made arrangements with the controlling ARTCC; otherwise, you need to file with AFSS via telephone. Be sure your preflight preparations are complete before filing. Your clearance will include a clearance void time. You must be airborne prior to the void time.
3. ARTCC: After takeoff, establish contact with Center. You may be in contact with multiple ARTCC facilities; they will coordinate the hand-offs.
4. EFAS/HIWAS: Coordinate with ATC before leaving their frequency to obtain in-flight weather information.
5. Approach Control: Center will hand you off to approach control where you will receive additional information and clearances. If you are able to land under visual meteorological conditions (VMC), you may cancel your IFR clearance before landing.

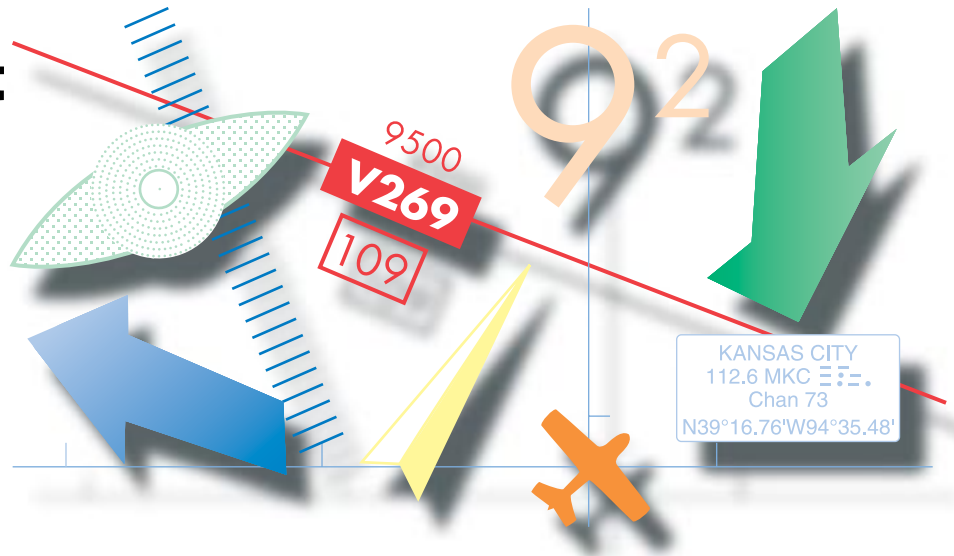
## Letters of Agreement (LOA)

The ATC system is indeed a system and very little happens by chance. As your flight progresses, controllers in adjoining sectors or adjoining Centers coordinate its handling by telephone or by computer. Where there is a boundary between the airspace controlled by different facilities, the location and altitude at which you will be handed off is determined by Letters of Agreement (LOA) negotiated between the two facility managers. This information is not available to you in any Federal Aviation Administration (FAA) publication. For this reason, it is good practice to note on your en route chart the points at which hand-offs occur as you fly over them. Each time you are handed off to a different facility, the controller knows your altitude and where you are—this was part of the hand-off procedure.

Communications Facility	Description	Frequency
Airport Advisory Area "[AFSS name] RADIO"	AFSS personnel provide traffic advisories to pilots operating within 10 miles of the airport.	123.6 MHz.
UNICOM "[airport name] UNICOM"	Airport advisories from an airport without an operating control tower or AFSS.	Listed in A/FD under the city name; also on sectional charts in airport data block.
Air Route Traffic Control Center (ARTCC) "CENTER"	En route radar facilities that maintain separation between IFR flights, and between IFR flights and known VFR flights. Centers will provide VFR traffic advisories on a workload permitting basis.	Listed in A/FD, and on instrument en route charts.
Approach/Departure Control "[airport name] APPROACH" (unless otherwise advised)	Positions at a terminal radar facility responsible for handling of IFR flights to and from the primary airport (where Class B airspace exists).	Listed in A/FD; also on sectional charts in the communications panel, and on terminal area charts.
Automatic Terminal Information Service (ATIS)	Continuous broadcast of audio tape prepared by ATC controller containing wind direction and velocity, temperature, altimeter setting, runway and approach in use, and other information of interest to pilots.	Listed in A/FD under the city name; also on sectional charts in airport data block and in the communications panel, and on terminal area charts.
Clearance Delivery "[airport name] CLEARANCE"	Control tower position responsible for transmitting departure clearances to IFR flights.	Listed on instrument approach procedure charts.
Common Traffic Advisory Frequency (CTAF)	CTAF provides a single frequency for pilots in the area to use for contacting the facility and/or broadcasting their position and intentions to other pilots.	Listed in A/FD; also on sectional charts in the airport data block (followed by a white C on a blue or magenta background). At airports with no tower, CTAF is 122.9, the "MULTICOM" frequency.
Automated Flight Service Station (AFSS) "[facility name] RADIO"	Provides information and services to pilots, using remote communications outlets (RCOs) and ground communications outlets (GCOs).	Listed in A/FD and sectional charts, both under city name and in a separate listing of AFSS frequencies. On sectional charts, listed above the VOR boxes, or in separate boxes when remote.
Ground Control "[airport name] GROUND"	At tower-controlled airports, a position in the tower responsible for controlling aircraft taxiing to and from the runways.	Listed in A/FD under city name.
Hazardous Inflight Weather Advisory Service (HIWAS)	Continuous broadcast of forecast hazardous weather conditions on selected NAVAIDs. No communication capability.	Black circle with white "H" in VOR frequency box; notation in A/FD airport listing under "Radio Aids to Navigation."
MULTICOM "[airport name] TRAFFIC"	Intended for use by pilots at airports with no radio facilities. Pilots should use self-announce procedures given in the AIM.	122.9 MHz. A/FD shows 122.9 as CTAF; also on sectional charts 122.9 is followed by a white C on a dark background, indicating CTAF.
Tower "[airport name] TOWER"	"Local" controller responsible for operations on the runways and in Class B, C, or D airspace surrounding the airport.	Listed in A/FD under city name; also on sectional and terminal control area charts in the airport data block and communications panel.
En Route Flight Advisory Service (EFAS) "FLIGHT WATCH"	For in-flight weather information.	122.0 MHz (0600-2200 local time)

**Figure 9-14.** ATC facilities, services, and radio call signs.

# IFR Flight



## Introduction

No single procedure can be outlined that is applicable to the planning and preparation involved with all flights conducted under instrument flight rules (IFR). Once you understand the overall operation of IFR flight, the many procedural details can be put into the appropriate sequence. This chapter explains the sources for flight planning, the conditions associated with instrument flight, and the procedures used for each phase of IFR flight: departure, en route, and approach. The chapter concludes with an example IFR flight, which applies many of the procedures learned earlier in the chapter.

## Sources of Flight Planning Information

In addition to current IFR en route charts, area charts, and United States (U.S.) Terminal Procedures Publications (TPP) published by the National Aeronautical Charting Office (NACO), the Federal Aviation Administration (FAA) publishes the *Aeronautical Information Manual (AIM)*, the *Airport/Facility Directory (A/FD)*, and the *Notices to Airmen Publication (NTAP)* for flight planning in the National Airspace System (NAS). Pilots should also consult the Pilot's Operating Handbook/Airplane Flight Manual (POH/AFM) for flight planning information pertinent to the aircraft to be flown.

## Preflight Planning Reference

In addition to approach procedures, the U.S. Terminal Procedures (TPP) booklets contain a wealth of flight planning information including IFR takeoff and alternate minimums, standard terminal arrival procedures, and departure procedures.

## Aeronautical Information Manual (AIM)

The AIM provides the aviation community with basic flight information and air traffic control (ATC) procedures used in the U.S. NAS. An international version called the *Aeronautical Information Publication* contains parallel information, as well as specific information on the international airports used by the international community.

## Airport/Facility Directory (A/FD)

The A/FD contains information on airports, communications, and navigation aids pertinent to IFR flight. It also includes very-high frequency omnidirectional range (VOR) receiver checkpoints, automated flight service station (AFSS), weather service telephone numbers, and air route traffic control center (ARTCC) frequencies. Various special notices essential to IFR flight are also included, such as land and hold short (LAHSO) data, the civil use of military fields, continuous power facilities, and special flight procedures.

In the major terminal and en route environments, preferred routes have been established to guide pilots in planning their routes of flight, to minimize route changes, and to aid in the orderly management of air traffic using the federal airways. The A/FD lists both high and low altitude preferred routes.



**Notices to Airmen Publication (NTAP)**

The NTAP is a publication containing current Notices to Airmen (NOTAMs) which are essential to the safety of flight, as well as supplemental data affecting the other operational publications listed. It also includes current Flight Data Center (FDC) NOTAMs, which are regulatory in nature, issued to establish restrictions to flight or to amend charts or published instrument approach procedures (IAPs).

**POH/AFM**

The POH/AFM contain operating limitations, performance, normal and emergency procedures, and a variety of other operational information for the respective aircraft. Aircraft manufacturers have done considerable testing to gather and substantiate the information in the aircraft manual. Pilots should refer to it for information relevant to a proposed flight.

A review of the contents of all the publications listed will help you determine which material should be referenced for each flight and those you would consult less frequently. As you become more familiar with these publications, you will be able to plan your IFR flights quickly and easily.

**IFR Flight Plan**

As specified in Title 14 of the Code of Federal Regulations (14 CFR) part 91, no person may operate an aircraft in **controlled airspace** under IFR unless that person has filed an IFR flight plan. Flight plans may be submitted to the nearest AFSS or air traffic control tower (ATCT) either in person, by telephone (1-800-WX-BRIEF), by computer (using the direct user access terminal system (DUATS)), or by radio if no other means are available. Pilots should file

Form Approved OMB No. 2120-0026

U.S. DEPARTMENT OF TRANSPORTATION FEDERAL AVIATION ADMINISTRATION		(FAA USE ONLY) <input type="checkbox"/> PILOT BRIEFING <input type="checkbox"/> VNR <input type="checkbox"/> STOPOVER			TIME STARTED	SPECIALIST INITIALS
<b>FLIGHT PLAN</b>						
1. TYPE	2. AIRCRAFT IDENTIFICATION	3. AIRCRAFT TYPE/SPECIAL EQUIPMENT	4. TRUE AIRSPEED	5. DEPARTURE POINT	6. DEPARTURE TIME	
<input checked="" type="checkbox"/> VFR <input type="checkbox"/> IFR <input type="checkbox"/> DVFR	N1230A	C182/G	140 KTS	DTW	PROPOSED (Z) 1300	ACTUAL (Z) 4000
8. ROUTE OF FLIGHT  DCT LFD DCT CMI						
9. DESTINATION (Name of airport and city) CMI-WILLARD AIRPORT SAVOY, IL		10. EST. TIME ENROUTE HOURS: 01 MINUTES: 42		11. REMARKS		
12. FUEL ON BOARD HOURS: 04 MINUTES: 20		13. ALTERNATE AIRPORT(S) ALN		14. PILOT'S NAME, ADDRESS & TELEPHONE NUMBER & AIRCRAFT HOME BASE WARREN SMITH, 123 MAIN STREET DETROIT, MI 48123 217-555-1212 DTW		15. NUMBER ABOARD 2
16. COLOR OF AIRCRAFT BLUE/WHITE		17. DESTINATION CONTACT/TELEPHONE (OPTIONAL)				
<small>CIVIL AIRCRAFT PILOTS. FAR Part 91 requires you file an IFR flight plan to operate under instrument flight rules in controlled airspace. Failure to file could result in a civil penalty not to exceed \$1,000 for each violation (Section 901 of the Federal Aviation Act of 1958, as amended). Filing of a VFR flight plan is recommended as a good operating practice. See also Part 99 for requirements concerning DVFR flight plans.</small>						

FAA Form 7233-1 (8-82)

CLOSE VFR FLIGHT PLAN WITH \_\_\_\_\_ FSS ON ARRIVAL

**Figure 10-1.** Flight plan form.

**Controlled airspace:** An airspace of defined dimensions within which ATC service is provided to IFR and visual flight rules (VFR) flights in accordance with the airspace classification. Includes Class A, Class B, Class C, Class D, and Class E airspace.

IFR flight plans at least 30 minutes prior to estimated time of departure to preclude possible delay in receiving a departure clearance from ATC. The AIM provides guidance for completing and filing FAA Form 7233-1, Flight Plan. These forms are available at flight service stations (FSS's), and are generally found in flight planning rooms at airport terminal buildings. [Figure 10-1]

### Filing in Flight

IFR flight plans may be filed from the air under various conditions, including:

1. A flight outside of controlled airspace before proceeding into IFR conditions in controlled airspace.
2. A VFR flight expecting IFR weather conditions en route in controlled airspace.

In either of these situations, the flight plan may be filed with the nearest AFSS or directly with the ARTCC. A pilot who files with the AFSS submits the information normally entered during preflight filing, except for “point of departure,” together with present position and altitude. AFSS then relays this information to the ARTCC. The ARTCC will then clear the pilot from present position or from a specified navigation fix.

A pilot who files direct with the ARTCC reports present position and altitude, and submits only the flight plan information normally relayed from the AFSS to the ARTCC. Be aware that traffic saturation frequently prevents ARTCC personnel from accepting flight plans by radio. In such cases, you will be advised to contact the nearest AFSS to file your flight plan.

### Canceling IFR Flight Plans

You may cancel your IFR flight plan any time you are operating in VFR conditions outside Class A airspace by stating “cancel my IFR flight plan” to the controller or air-to-ground station with which you are communicating. After canceling your IFR flight plan, you should change to the appropriate air-to-ground frequency, appropriate transponder code as directed, and VFR altitude/flight level.

ATC separation and information services (including radar services, where applicable) are discontinued. If you desire VFR radar advisory service, you must specifically request it. Be aware that other procedures may apply if you cancel

your IFR flight plan within areas such as Class C or Class B airspace.

If you are operating on an IFR flight plan to an airport with an operating control tower, your flight plan is canceled automatically upon landing. If you are operating on an IFR flight plan to an airport without an operating control tower, you must cancel the flight plan. This can be done by telephone after landing if there is no operating FSS, or other means of direct communications with ATC. If there is no FSS and air-to-ground communications with ATC are not possible below a certain altitude, you may cancel your IFR flight plan while still airborne and able to communicate with ATC by radio. If you follow this procedure, be certain the remainder of your flight can be conducted under VFR. It is essential that you cancel your IFR flight plan expeditiously. This allows other IFR traffic to utilize the airspace.

### Clearances

An ATC **clearance** allows an aircraft to proceed under specified traffic conditions within controlled airspace for the purpose of providing separation between known aircraft.

### Examples

A flight filed for a short distance at a relatively low altitude in an area of low traffic density might receive a clearance as follows:

“Cessna 1230 Alpha, cleared to Doeville airport direct, cruise 5,000.”

The term “cruise” in this clearance means you are authorized to fly at any altitude from the minimum IFR altitude up to and including 5,000 feet. You may level off at any altitude within this block of airspace. A climb or descent within the block may be made at your discretion. However, once you have reported leaving an altitude within the block, you may not return to that altitude without further ATC clearance.

When ATC issues a **cruise clearance** in conjunction with an unpublished route, an appropriate crossing altitude will be specified to ensure terrain clearance until the aircraft reaches a fix, point, or route where the altitude information is available. The crossing altitude ensures IFR obstruction clearance to the point at which the aircraft enters a segment of a published route or IAP.

**Clearance:** Allows an aircraft to proceed under specified traffic conditions within controlled airspace, for the purpose of providing separation between known aircraft.

**Cruise clearance:** Used in an ATC clearance to allow a pilot to conduct flight at any altitude from the minimum IFR altitude up to and including the altitude specified in the clearance. Also authorizes a pilot to proceed to and make an approach at the destination airport.

Once a flight plan is filed, ATC will issue the clearance with appropriate instructions, such as the following:

“Cessna 1230 Alpha is cleared to Skyline airport via the Crossville 055 radial, Victor 18, maintain 5,000. Clearance void if not off by 1330.”

You may receive a more complex clearance, such as:

“Cessna 1230 Alpha is cleared to Wichita Mid-continent airport via Victor 77, left turn after takeoff, proceed direct to the Oklahoma City VORTAC. Hold west on the Oklahoma City 277 radial, climb to 5,000 in holding pattern before proceeding on course. Maintain 5,000 to CASHION intersection. Climb to and maintain 7,000. Departure control frequency will be 121.05. Squawk 0412.”

Suppose you are awaiting departure clearance at a busy metropolitan terminal (your first IFR departure from this airport). On an average day, the tower at this airport controls departures at a rate of one every 2 minutes to maintain the required traffic flow. Sequenced behind you are a number of aircraft ready for departure, including jet transports.

**Clearance delivery** may issue you the following “abbreviated clearance” which includes a **departure procedure (DP)**:

“Cessna 1230 Alpha, cleared to La Guardia as filed, RINGOES 8 departure Phillipsburg transition, maintain 8,000. Departure control frequency will be 120.4, Squawk 0700.”

This clearance may be readily copied in shorthand as follows:

“CAF RNGO8 PSB M80 DPC 120.4 SQ 0700.”

The information contained in this DP clearance is abbreviated using clearance shorthand (*see* appendix 1). You should know the locations of the specified navigation facilities, together with the route and point-to-point time, before accepting the clearance.

**Clearance delivery:** Control tower position responsible for transmitting departure clearances to IFR flights.

**Departure procedure (DP):** Preplanned IFR ATC departure/obstacle avoidance procedures, published for pilot use in textual and graphic format.

The DP enables you to study and understand the details of your departure before filing an IFR flight plan. It provides the information necessary for you to set up your communication and navigation equipment and be ready for departure before requesting IFR clearance from the tower.

Once the clearance is accepted, you are required to comply with ATC instructions. You may request a clearance different from that issued if you consider another course of action more practicable or if your aircraft equipment limitations or other considerations make acceptance of the clearance inadvisable.

Pilots should also request clarification or amendment, as appropriate, any time a clearance is not fully understood or considered unacceptable because of safety of flight. *The pilot is responsible for requesting an amended clearance* if ATC issues a clearance that would cause a pilot to deviate from a rule or regulation or would place the aircraft in jeopardy.

### **Clearance Separations**

ATC will provide the pilot on an IFR clearance with separation from other IFR traffic. This separation is provided:

1. Vertically—by assignment of different altitudes.
2. Longitudinally—by controlling time separation between aircraft on the same course.
3. Laterally—by assignment of different flightpaths.
4. By radar—including all of the above.

ATC does *not* provide separation for an aircraft operating:

1. Outside controlled airspace;
2. On an IFR clearance:
  - a. With “VFR-On-Top” authorized instead of a specific assigned altitude.
  - b. Specifying climb or descent in “VFR conditions.”
  - c. At any time in VFR conditions, since uncontrolled VFR flights may be operating in the same airspace.

In addition to heading and altitude assignments, ATC will occasionally issue speed adjustments to maintain the required separations. For example:

“Cessna 30 Alpha, slow to 100 knots.”

### **See and Avoid**

An IFR clearance does **not** relieve the pilot in command of responsibility to see and avoid traffic while operating in visual conditions.

Pilots who receive speed adjustments are expected to maintain that speed plus or minus 10 knots. If for any reason the pilot is not able to accept a speed restriction, the pilot should advise ATC.

At times, ATC may also employ visual separation techniques to keep aircraft safely separated. A pilot who obtains visual contact with another aircraft may be asked to maintain visual separation or to follow the aircraft. For example:

“Cessna 30 Alpha, maintain visual separation with that traffic, climb and maintain 7,000.”

The pilot’s acceptance of instructions to maintain visual separation or to follow another aircraft is an acknowledgment that he or she will maneuver the aircraft, as necessary, to maintain safe separation. It is also an acknowledgment that the pilot accepts the responsibility for wake turbulence avoidance.

In the absence of radar contact, ATC will rely on **position reports** to assist in maintaining proper separation. Using the data transmitted by the pilot, the controller follows the progress of your flight. ATC must correlate your reports with all the others to provide separation; therefore, the accuracy of your reports can affect the progress and safety of every other aircraft operating in the area on an IFR flight plan.

### Departure Procedures (DPs)

DPs are designed to expedite clearance delivery, to facilitate transition between takeoff and en route operations, and to ensure adequate obstacle clearance. They furnish pilots’ departure routing clearance information in both graphic and textual form. To simplify clearances, DPs have been established for the most frequently used departure routes in areas of high traffic activity. A DP will normally be used where such departures are available, since this is advantageous to both users and ATC. [Figure 10-2]

DPs can be found in section C of each booklet published regionally by the NACO, **TPP**, along with “IFR Take-off Minimums.” The following points are important to remember if you file IFR out of terminal areas where DPs are in use.

**Position report:** A report over a known location as transmitted by the pilot to ATC.

**TPP:** Booklets published in regional format by the NACO that include DPs, standard terminal arrivals (STARs), IAPs, and other information pertinent to IFR flight.

1. Pilots of IFR aircraft operating from locations where DP procedures are effective may expect an ATC clearance containing a DP. The use of a DP requires pilot possession of at least the textual description of the approved DP.
2. If you do not possess a preprinted DP or for any other reason do not wish to use a DP, you are expected to advise ATC. Notification may be accomplished by filing “NO DP” in the remarks section of the filed flight plan, or by advising ATC.
3. If you accept a DP in your clearance, you must comply with it.

### Radar Controlled Departures

On your IFR departures from airports in congested areas, you will normally receive navigational guidance from departure control by radar vector. When your departure is to be vectored immediately following takeoff, you will be advised before takeoff of the initial heading to be flown. This information is vital in the event you experience a loss of two-way radio communications during departure.

The radar departure is normally simple. Following takeoff, you contact departure control on the assigned frequency when advised to do so by the control tower. At this time departure control verifies radar contact, and gives headings, altitude, and climb instructions to move you quickly and safely out of the terminal area. Fly the assigned headings and altitudes until the controller tells you your position with respect to the route given in your clearance, whom to contact next, and to “resume your own navigation.”

Departure control will vector you to either a navigation facility or an en route position appropriate to your departure clearance, or you will be transferred to another controller with further radar surveillance capabilities. [Figure 10-2]

A radar controlled departure does not relieve you of your responsibilities as pilot in command. You should be prepared before takeoff to conduct your own navigation according to your ATC clearance, with navigation receivers checked and properly tuned. While under radar control, monitor your instruments to ensure that you are continuously oriented to the route specified in your clearance, and record the time over designated checkpoints.

### Obstacle Avoidance

When departing from airports without operating control towers in IFR conditions, adhere to the published obstacle departure procedure (DP), if applicable.

DEPARTURE ROUTE DESCRIPTION

**TAKE-OFF RUNWAYS 3L AND 3C:** Climb runway heading to 1100 feet before turning. Thence . . . .

**TAKE-OFF ALL OTHER RUNWAYS:** Thence . . . .

. . . . Climb on assigned heading for vectors to join the assigned Airway or Radial then proceed to the assigned departure fix, thence via the assigned route. Jets maintain 10,000 feet, cross the DXO 10 DME Arc at or above 5,000 feet for noise abatement. If unable to comply, advise ATC prior to departure. Props maintain 4000 feet or lower assigned altitude. Expect clearance to filed altitude/flight level ten (10) minutes after departure.

**SPECIAL INSTRUCTIONS:** When using this departure, file the appropriate depicted departure fix and route. Aircraft landing/overflying Lansing (LAN) or overflying Flint (FNT) at 8,000 feet or below, file via EARVN. Aircraft landing Flint (FNT) at 8,000 feet or below, file via LAYNE. ANNTS, Jets only. Jets use Departure Control Frequency 125.525. Props use Departure Control Frequency 118.95.

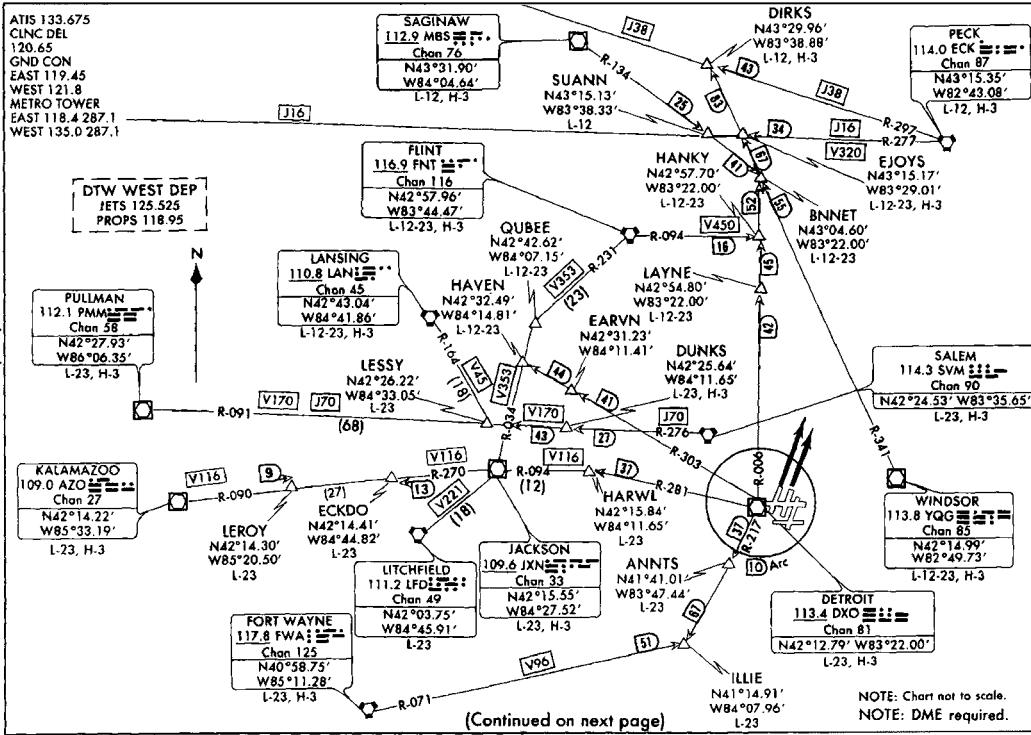


Figure 10-2. Departure procedure (DP).

### **Departures from Airports Without an Operating Control Tower**

When you are departing from airports that have neither an operating tower nor an FSS, you should telephone your flight plan to the nearest ATC facility at least 30 minutes before your estimated departure time. If weather conditions permit, you could depart VFR and request IFR clearance as soon as radio contact is established with ATC. If weather conditions make it undesirable to fly VFR, you could again telephone and request clearance. In this case, the controller would probably issue a short-range clearance pending establishment of radio contact, and might restrict your departure time to a certain period. For example:

“Clearance void if not off by 0900.”

This would authorize you to depart within the allotted period and proceed in accordance with your clearance. In the absence of any specific departure instructions, you would be expected to proceed on course via the most direct route.

### **En Route Procedures**

Procedures en route will vary according to the proposed route, the traffic environment, and the ATC facilities controlling the flight. Some IFR flights are under radar surveillance and controlled from departure to arrival and others rely entirely on pilot navigation.

Where ATC has no jurisdiction, it does not issue an IFR clearance. It has no control over the flight; nor does the pilot have any assurance of separation from other traffic.

### **ATC Reports**

All pilots are required to report unforecast weather conditions or other information related to safety of flight to ATC. Pilots of aircraft operated in controlled airspace under IFR, are also required to immediately report to ATC any of the following equipment malfunctions occurring in flight:

1. Loss of VOR, tactical air navigation (TACAN) or automatic direction finder (ADF) receiver capability.
2. Complete or partial loss of instrument landing system (ILS) receiver capability.
3. Impairment of air-to-ground communications capability.

### **VFR Departures**

When departing VFR to receive an IFR clearance airborne, consider obstacle clearance, airspace, VFR cloud clearance requirements, and an alternate plan of action if an IFR clearance cannot be received.

In each report, pilots are expected to include aircraft identification, equipment affected, and degree to which IFR operational capability in the ATC system is impaired. The nature and extent of assistance desired from ATC must also be stated.

### **Position Reports**

Unless in radar contact with ATC, you are required to furnish a position report over certain reporting points. Position reports are required over each compulsory reporting point (shown on the chart as solid triangle figures ▲ ) along the route being flown regardless of altitude, including those with a VFR-On-Top clearance. Along direct routes, reports are required of all IFR flights over each point used to define the route of flight. Reports at reporting points (shown as open triangle figures △ ) are made only when requested by ATC.

Position reports should include the following items:

1. Identification.
2. Position.
3. Type of flight plan, if your report is made to an AFSS.
4. The estimated time of arrival (ETA) over next reporting point.
5. The name only of the next succeeding (required) reporting point along the route of flight.
6. Pertinent remarks.

En route position reports are submitted normally to the ARTCC controllers via direct controller-to-pilot communications channels, using the appropriate ARTCC frequencies listed on the en route chart.

Whenever an initial Center contact is to be followed by a position report, the name of the reporting point should be included in the callup. This alerts the controller that such information is forthcoming. For example:

“Cleveland Center, Cessna 1230 Alpha at HARWL intersection.”

## Additional Reports

In addition to other required reports, the following reports should be made to ATC:

1. When vacating any previously assigned altitude or flight level (FL) for a newly assigned altitude or FL.
2. When an altitude change will be made, when operating on a VFR-On-Top clearance.
3. When an approach has been missed (request clearance for specific action (e.g., to alternate airport, another approach, etc.)).

*(The following reports are not required if in radar contact with ATC:)*

4. The time and altitude or FL reaching a holding fix or point to which cleared.
5. When leaving any assigned holding fix or point.
6. When leaving final approach fix (FAF) inbound on final approach.
7. A corrected estimate at any time it becomes apparent that an estimate previously submitted is in error in excess of 3 minutes.

## Planning the Descent and Approach

ATC arrival procedures and cockpit workload are affected by weather conditions, traffic density, aircraft equipment, and radar availability.

When landing at airports with approach control services and where two or more IAPs are published, you will be provided in advance of arrival with information on the type of approach to expect or if you will be vectored for a visual approach. This information will be broadcast either on automated terminal information service (ATIS) or by a controller. It will not be furnished when the visibility is 3 miles or better and the ceiling is at or above the highest initial approach altitude established for any low altitude IAP for the airport.

The purpose of this information is to help you in planning arrival actions; however, it is not an ATC clearance or commitment and is subject to change. Fluctuating weather, shifting winds, blocked runway, etc., are conditions that may result in changes to the approach information you previously received. It is important to advise ATC immediately if you are unable to execute the approach, or if you prefer, another type of approach.

If the destination is an airport without an operating control tower, and has automated weather data with broadcast capability, you should monitor the automated surface observing system/automated weather observing system (ASOS/AWOS) frequency to ascertain the current weather for the airport. You should advise ATC once you have received the broadcast weather and state your intentions.

Once you know which approach you will execute, you should plan for the descent prior to the initial approach fix (IAF) or transition route depicted on the IAP. When flying the transition route, maintain the last assigned altitude until you hear “cleared for the approach” and have intercepted a segment of the approach. You may “request lower” to bring your transition route closer to the required altitude for the initial approach altitude. When ATC uses the phrase, “at pilot’s discretion” in the altitude information of a clearance, you have the option to start a descent at any rate, and you may level off temporarily at any intermediate altitude. However, once you have vacated an altitude, you may not return to that altitude. When ATC has *not* used the term “at pilot’s discretion” nor imposed any descent restrictions, you should initiate descent promptly upon acknowledgment of the clearance.

Descend at an optimum rate (consistent with the operating characteristics of the aircraft) to 1,000 feet above the assigned altitude. Then attempt to descend at a rate of between 500 and 1,500 feet per minute (fpm) until the assigned altitude is reached. If at anytime you are unable to descend at a rate of at least 500 fpm, advise ATC. Advise ATC if it is necessary to level off at an intermediate altitude during descent. An exception to this is when leveling off at 10,000 feet mean sea level (MSL) on descent, or 2,500 feet above airport elevation (prior to entering a Class B, Class C, or Class D surface area) when required for speed reduction.

## Standard Terminal Arrival Routes (STARs)

**Standard terminal arrival routes** (as described in Chapter 8) have been established to simplify clearance delivery procedures for arriving aircraft at certain areas having high density traffic. A STAR serves a purpose parallel to that of a DP for departing traffic. [Figure 10-3] The following points regarding STARs are important to remember:

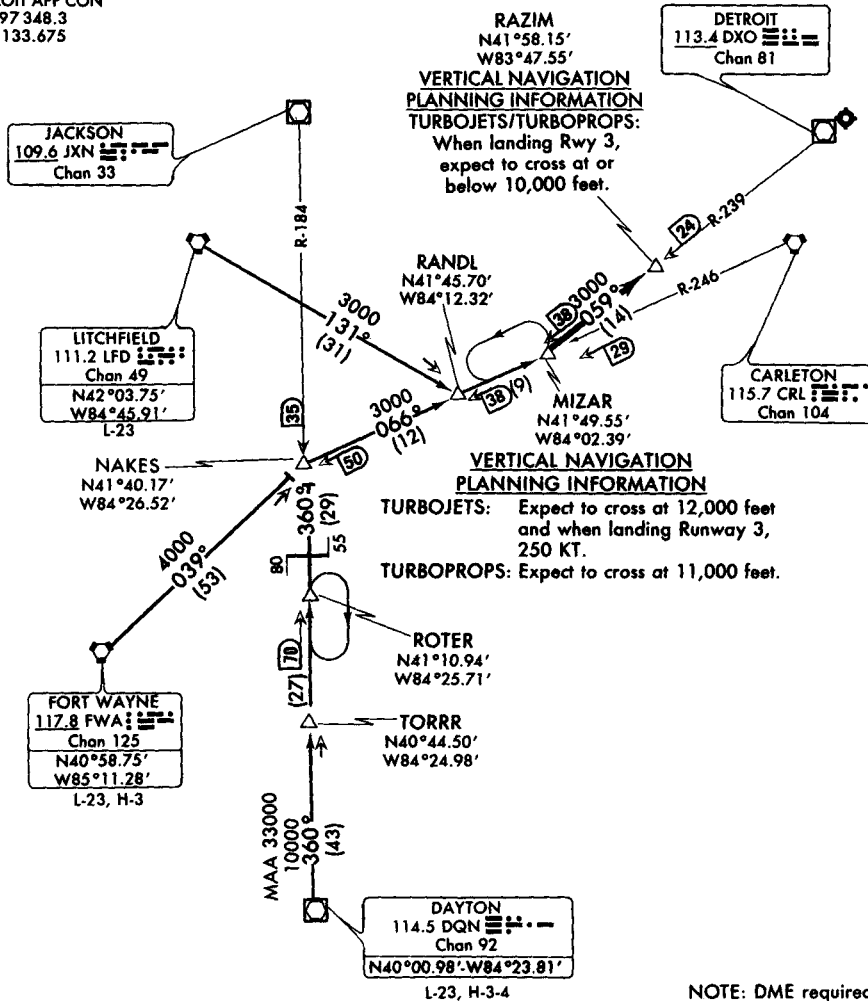
1. All STARs are contained in the TPP, along with the IAP charts for your destination airport. The AIM also describes STAR procedures.

**Standard terminal arrival route (STAR):** A preplanned IFR ATC arrival procedure published for pilot use in graphic and/or textual form.

00167

**MIZAR THREE ARRIVAL (MIZAR.MIZAR3)** ST-119 (FAA) DETROIT METROPOLITAN WAYNE COUNTY  
DETROIT, MICHIGAN

DETROIT APP CON  
124.97348.3  
ATIS 133.675



NOTE: DME required.  
NOTE: Chart not to scale.

**DAYTON TRANSITION (DQN.MIZAR3):** From over DQN VOR/DME via DQN R-360 and JXN R-184 to NAKES INT, then via CRL VORTAC R-246 to MIZAR DME. Thence. . . .  
**FORT WAYNE TRANSITION (FWA.MIZAR3):** From over FWA VORTAC via FWA R-039 to NAKES INT, then via CRL R-246 to MIZAR DME. Thence. . . .  
**LITCHFIELD TRANSITION (LFD.MIZAR3):** From over LFD VORTAC via LFD R-131 to RANDL INT, then via CRL R-246 to MIZAR DME. Thence. . . .  
 . . . . From over MIZAR DME via DXO VOR/DME R-239 to RAZIM DME. Expect radar vectors to final approach course.

**MIZAR THREE ARRIVAL (MIZAR.MIZAR3)** DETROIT, MICHIGAN  
DETROIT METROPOLITAN WAYNE COUNTY

00167

Figure 10-3. Standard terminal arrival route (STAR).



2. If your destination is a location for which STARs have been published, you may be issued a clearance containing a STAR whenever ATC deems it appropriate. You must possess at least the approved textual description.
3. It is your responsibility to either accept or refuse an issued STAR. If you do not wish to use a STAR, you should advise ATC by placing “NO STAR” in the remarks section of your filed flight plan or by advising ATC.
4. If you accept a STAR in your clearance, you must comply with it.

### Substitutes for Inoperative or Unusable Components

The basic ground components of an ILS are the localizer, glide slope, outer marker, middle marker, and inner marker (when installed). A **compass locator** or precision radar may be substituted for the outer or middle marker. Distance measuring equipment (DME), VOR, or nondirectional beacon (NDB) fixes authorized in the standard IAP or surveillance radar may be substituted for the outer marker.

Additionally, IFR-certified global positioning system (GPS) equipment, operated in accordance with Advisory Circular (AC) 90-94, *Guidelines for Using Global Positioning System Equipment for IFR En Route and Terminal Operations and for Nonprecision Instrument Approaches in the U.S. NAS*, may be substituted for ADF and DME equipment, except for when flying NDB IAP. Specifically, GPS can be substituted for ADF and DME equipment when:

1. Flying a DME arc;
2. Navigating TO/FROM an NDB;
3. Determining the aircraft position over an NDB;
4. Determining the aircraft position over a fix made up of a crossing NDB bearing;
5. Holding over an NDB;
6. Determining aircraft position over a DME fix.

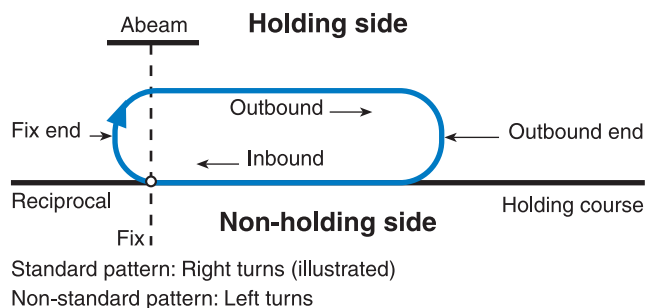
### Holding Procedures

Depending upon traffic and weather conditions, holding may be required. **Holding** is a predetermined maneuver which keeps aircraft within a specified airspace while awaiting

further clearance from ATC. A standard holding pattern uses right turns, and a nonstandard holding pattern uses left turns. The ATC clearance will always specify left turns when a nonstandard pattern is to be flown.

#### Standard Holding Pattern (No Wind)

The **standard holding pattern** is a racetrack pattern. [Figure 10-4] The aircraft follows the specified course inbound to the holding fix, turns 180° to the right, flies a parallel straight course outbound for 1 minute, turns 180° to the right, and flies the inbound course to the fix.



**Figure 10-4.** Standard holding pattern—no wind.

#### Standard Holding Pattern (With Wind)

In compliance with the holding pattern procedures given in the AIM, the symmetrical racetrack pattern cannot be tracked when a wind exists. Pilots are expected to:

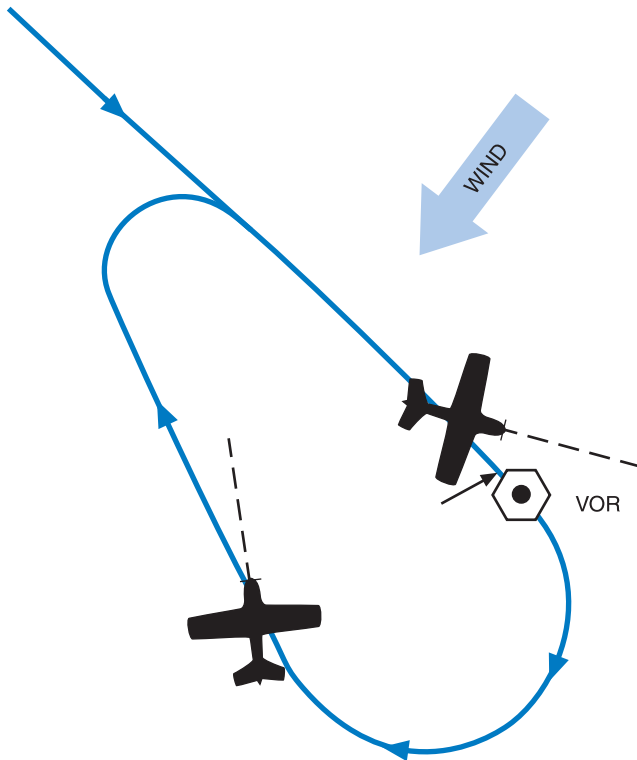
1. Compensate for the effect of a known wind except when turning.
2. Adjust outbound timing so as to achieve a 1-minute (1-1/2 minutes above 14,000 feet) inbound leg.

Figure 10-5 illustrates the holding track followed with a left crosswind. The effect of wind is counteracted by applying drift corrections to the inbound and outbound legs and by applying time allowances to the outbound leg.

**Compass locator:** A low-power, low- or medium-frequency (L/MF) radio beacon installed at the site of the outer or middle marker of an ILS.

**Holding:** A predetermined maneuver that keeps aircraft within a specified airspace while awaiting further clearance from ATC.

**Standard holding pattern:** A holding pattern in which all turns are made to the right.



**Figure 10-5.** *Drift correction in holding pattern.*

### Holding Instructions

If you arrive at your clearance limit before receiving clearance beyond the fix, ATC expects you to maintain the last assigned altitude and begin holding in accordance with the depicted holding pattern. If no holding pattern is depicted, you are expected to begin holding in a standard holding pattern on the course upon which you approached the fix. You should immediately request further clearance. Normally, when no delay is anticipated, ATC will issue holding instructions at least 5 minutes before your estimated arrival at the fix. Where a holding pattern is not depicted, the ATC clearance will specify the following:

1. Direction of holding from the fix in terms of the eight cardinal compass points (i.e., N, NE, E, SE, etc.).
2. Holding fix (the fix may be omitted if included at the beginning of the transmission as the clearance limit).

### Holding (With Wind)

To compensate for the effects of wind while holding, triple the outbound correction in the opposite direction of your inbound wind correction angle. For example, if you are holding an 8° left wind correction for the inbound course, correct 24° to the right on the outbound leg.

3. Radial, course, bearing, airway, or route on which the aircraft is to hold.
4. Leg length in miles if DME or area navigation (RNAV) is to be used (leg length will be specified in minutes on pilot request or if the controller considers it necessary).
5. Direction of turn if left turns are to be made, the pilot requests or the controller considers it necessary.
6. Time to **expect-further-clearance (EFC)** and any pertinent additional delay information.

ATC instructions will also be issued whenever:

1. It is determined that a delay will exceed 1 hour.
2. A revised EFC is necessary.
3. In a terminal area having a number of navigation aids and approach procedures, a clearance limit may not indicate clearly which approach procedures will be used. On initial contact, or as soon as possible thereafter, approach control will advise you of the type of approach you may anticipate.
4. Ceiling and/or visibility is reported as being at or below the highest “circling minimums” established for the airport concerned. ATC will transmit a report of current weather conditions and subsequent changes, as necessary.
5. Aircraft are holding while awaiting approach clearance, and pilots advise that reported weather conditions are below minimums applicable to their operation. In this event, ATC will issue suitable instructions to aircraft desiring either to continue holding while awaiting weather improvement or proceed to another airport.

### Standard Entry Procedures

The entry procedures given in the AIM evolved from extensive experimentation under a wide range of operational conditions. The standardized procedures should be followed to ensure that you remain within the boundaries of the prescribed holding airspace.

Reduce airspeed to holding speed within 3 minutes of your ETA at the holding fix. The purpose of the speed reduction is to prevent overshooting the holding airspace limits, especially at locations where adjacent holding patterns are

### Expect-further-clearance (EFC):

The time a pilot can expect to receive clearance beyond a clearance limit.

close together. The exact time at which you reduce speed is not important as long as you arrive at the fix at your pre-selected holding speed within 3 minutes of your submitted ETA. If it takes more than 3 minutes for you to complete a speed reduction and ready yourself for identification of the fix, adjustment of navigation and communications equipment, entry to the pattern, and reporting, make the necessary time allowance.

All aircraft may hold at the following altitudes and maximum holding airspeeds:

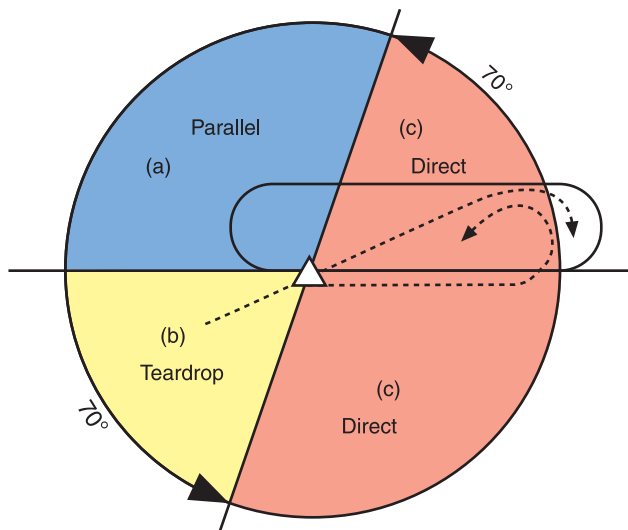
Altitude (MSL)	Airspeed (KIAS)
MHA – 6,000 feet	200
6,001 – 14,000 feet	230
14,001 feet and above	265

The following are exceptions to the maximum holding airspeeds:

1. Holding patterns from 6,001 to 14,000 feet may be restricted to a maximum airspeed of 210 knots indicated airspeed (KIAS). This nonstandard pattern will be depicted by an icon.
2. Holding patterns may be restricted to a maximum airspeed of 175 KIAS. This nonstandard pattern will be depicted by an icon. Holding patterns restricted to 175 KIAS will generally be found on IAPs applicable to category A and B aircraft only.
3. Holding patterns at Air Force airfields only—310 KIAS maximum, unless otherwise depicted.
4. Holding patterns at Navy airfields only—230 KIAS maximum, unless otherwise depicted.
5. Advise ATC if you need to exceed a maximum holding speed.

You may want to use the maximum endurance speed when executing a holding pattern in order to save fuel. However, there are several reasons why you would not want to use the maximum endurance speed for holding. You should use a speed for holding patterns that will give you good aircraft control without increasing workload, minimizing fuel burn (as much as possible), and provides a safe margin above stall.

While other entry procedures may enable the aircraft to enter the holding pattern and remain within protected airspace, the parallel, teardrop and direct entries are the procedures for entry, and holding recommended by the FAA. [Figure 10-6]



**Figure 10-6.** Holding pattern entry procedures.

1. Parallel procedure: When approaching the holding fix from anywhere in sector (a), turn to a heading to parallel the holding course outbound on the nonholding side for approximately 1 minute, turn in the direction of the holding pattern through more than 180°, and return to the holding fix or intercept the holding course inbound.
2. Teardrop procedure: When approaching the holding fix from anywhere in sector (b), fly to the fix, turn outbound using course guidance when available, or to a heading for a 30° teardrop entry within the pattern (on the holding side) for approximately 1 minute, then turn in the direction of the holding pattern to intercept the inbound holding course.
3. Direct entry procedure: When approaching the holding fix from anywhere in sector (c), fly directly to the fix and turn to follow the holding pattern.

Pilots should make all turns during entry and while holding at:

1. 3° per second, or
2. 30° bank angle, or
3. a bank angle provided by a flight director system.

### Time Factors

The holding pattern entry time reported to ATC is the initial time of arrival over the fix. Upon entering a holding pattern, the initial outbound leg is flown for 1 minute at or below 14,000 feet MSL, and for 1-1/2 minutes above 14,000 feet MSL. Timing for subsequent outbound legs should be adjusted as necessary to achieve proper inbound leg time. Pilots should begin outbound timing over or abeam the fix, whichever occurs later. If the abeam position cannot be determined, start timing when the turn to outbound is completed. [Figure 10-7]

EFC times require no time adjustment since the purpose for issuance of these times is to provide for possible loss of two-way radio communications. You will normally receive further clearance prior to your EFC. If you do not receive it, request a revised EFC time from ATC.

Time leaving the holding fix must be known to ATC before succeeding aircraft can be cleared to the airspace you have vacated. Leave the holding fix:

1. When ATC issues either further clearance en route or approach clearance;
2. As prescribed in part 91 (for IFR operations; two-way radio communications failure, and responsibility and authority of the pilot in command); or

3. After you have canceled your IFR flight plan, if you are holding in VFR conditions.

### DME Holding

The same entry and holding procedures apply to DME holding except distances (nautical miles) are used instead of time values. The length of the outbound leg will be specified by the controller, and the end of this leg is determined by the DME readout.

### Approaches

#### Compliance with Published Standard Instrument Approach Procedures

Compliance with the approach procedures shown on the approach charts provides necessary navigation guidance information for alignment with the final approach courses, as well as obstruction clearance. Under certain conditions, a course reversal maneuver or procedure turn may be necessary. However, this procedure is not authorized when:

1. The symbol “NoPT” appears on the approach course on the plan view of the approach chart.
2. Radar vectoring is provided to the final approach course.
3. A holding pattern is published in lieu of a procedure turn.
4. Executing a timed approach from a holding fix.
5. Otherwise directed by ATC.

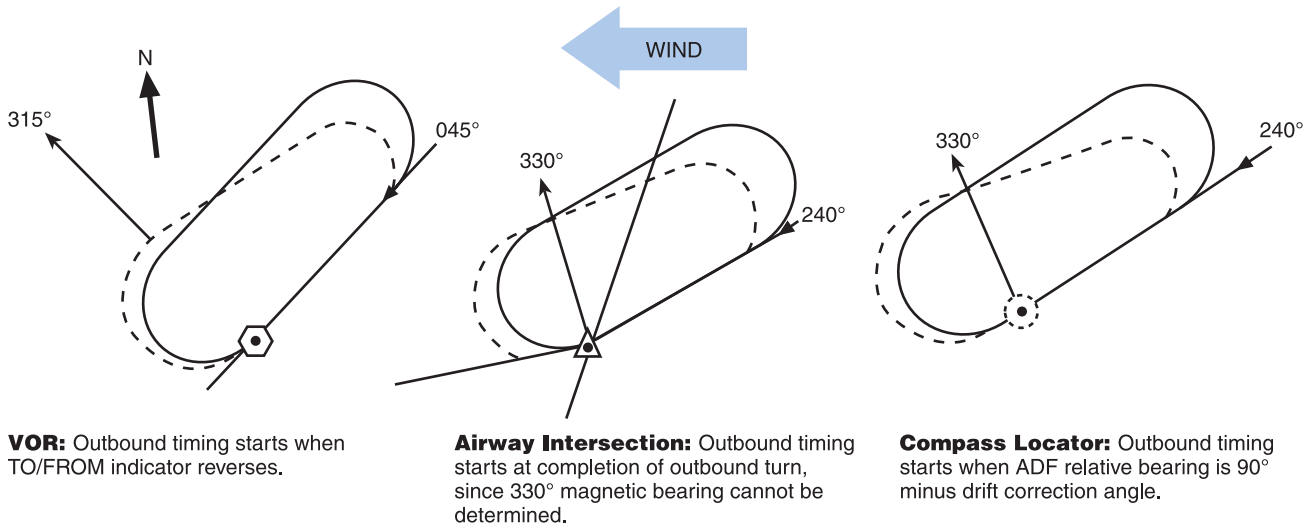


Figure 10-7. Holding—outbound timing.

NoPT: No procedure turn.

## **Instrument Approaches to Civil Airports**

Unless otherwise authorized, when an instrument letdown to an airport is necessary, pilots should use a standard IAP prescribed for that airport. IAPs are depicted on IAP charts and are found in the TPP.

ATC approach procedures depend upon the facilities available at the terminal area, the type of instrument approach executed, and the existing weather conditions. The ATC facilities, navigation aids (NAVAIDs), and associated frequencies appropriate to each standard instrument approach are given on the approach chart. Individual charts are published for standard approach procedures associated with the following types of facilities:

1. Nondirectional beacon (NDB)
2. Very-high frequency omnirange (VOR)
3. Very-high frequency omnirange with distance measuring equipment (VORTAC or VOR/DME)
4. Localizer (LOC)
5. Instrument landing system (ILS)
6. Localizer-type directional aid (LDA)
7. Simplified directional facility (SDF)
8. Area navigation (RNAV)
9. Global positioning system (GPS)

An IAP can be flown in one of two ways: as a full approach or with the assistance of radar vectors. When the IAP is flown as a full approach, pilots conduct their own navigation using the routes and altitudes depicted on the instrument approach chart. A full approach allows the pilot to transition from the en route phase, to the instrument approach, and then to a landing with minimal assistance from ATC. This type of procedure may be requested by the pilot but is most often used in areas without radar coverage. A full approach also provides the pilot with a means of completing an instrument approach in the event of a communications failure.

When an approach is flown with the assistance of radar vectors, ATC provides guidance in the form of headings and altitudes which positions the aircraft to intercept the final approach. From this point, the pilot resumes navigation, intercepts the final approach course, and completes the approach using the IAP chart. This is often a more expedient method of flying the approach, as opposed to the full approach, and allows ATC to sequence arriving traffic. A pilot operating in radar contact can generally expect the assistance of radar vectors to the final approach course.

### *Approach to Airport Without an Operating Control Tower*

Figure 10-8 shows an approach procedure at an airport without an operating control tower. As you approach such a facility, you should monitor the AWOS/ASOS if available for the latest weather conditions. When direct communication between the pilot and controller is no longer required, the ARTCC or approach controller will clear you for an instrument approach and advise “change to advisory frequency approved.” If you are arriving on a “cruise” clearance, ATC will not issue further clearance for approach and landing.

If an approach clearance is required, ATC will authorize you to execute your choice of standard instrument approach (if more than one is published for the airport) with the phrase “Cleared for the approach” and the communications frequency change required, if any. From this point on, you will have no contact with ATC. Accordingly, you must close your IFR flight plan before landing, if in VFR conditions, or by telephone after landing.

Unless otherwise authorized by ATC, you are expected to execute the complete IAP shown on the chart.

### *Approach to Airport With an Operating Tower, With No Approach Control*

When you approach an airport with an operating control tower, but no approach control, ATC will clear you to an approach/outer fix with the appropriate information and instructions as follows:

1. Name of the fix;
2. Altitude to be maintained;
3. Holding information and expected approach clearance time, if appropriate; and
4. Instructions regarding further communications, including:
  - a. facility to be contacted.
  - b. time and place of contact.
  - c. frequency/ies to be used.

If the tower has ATIS, you should monitor that frequency for such information as ceiling, visibility, wind direction and velocity, altimeter setting, instrument approach, and runways in use prior to initial radio contact with approach control. If there is no ATIS, ATC will, at the time of your first radio contact or shortly thereafter, provide weather information from the nearest reporting station to your destination.

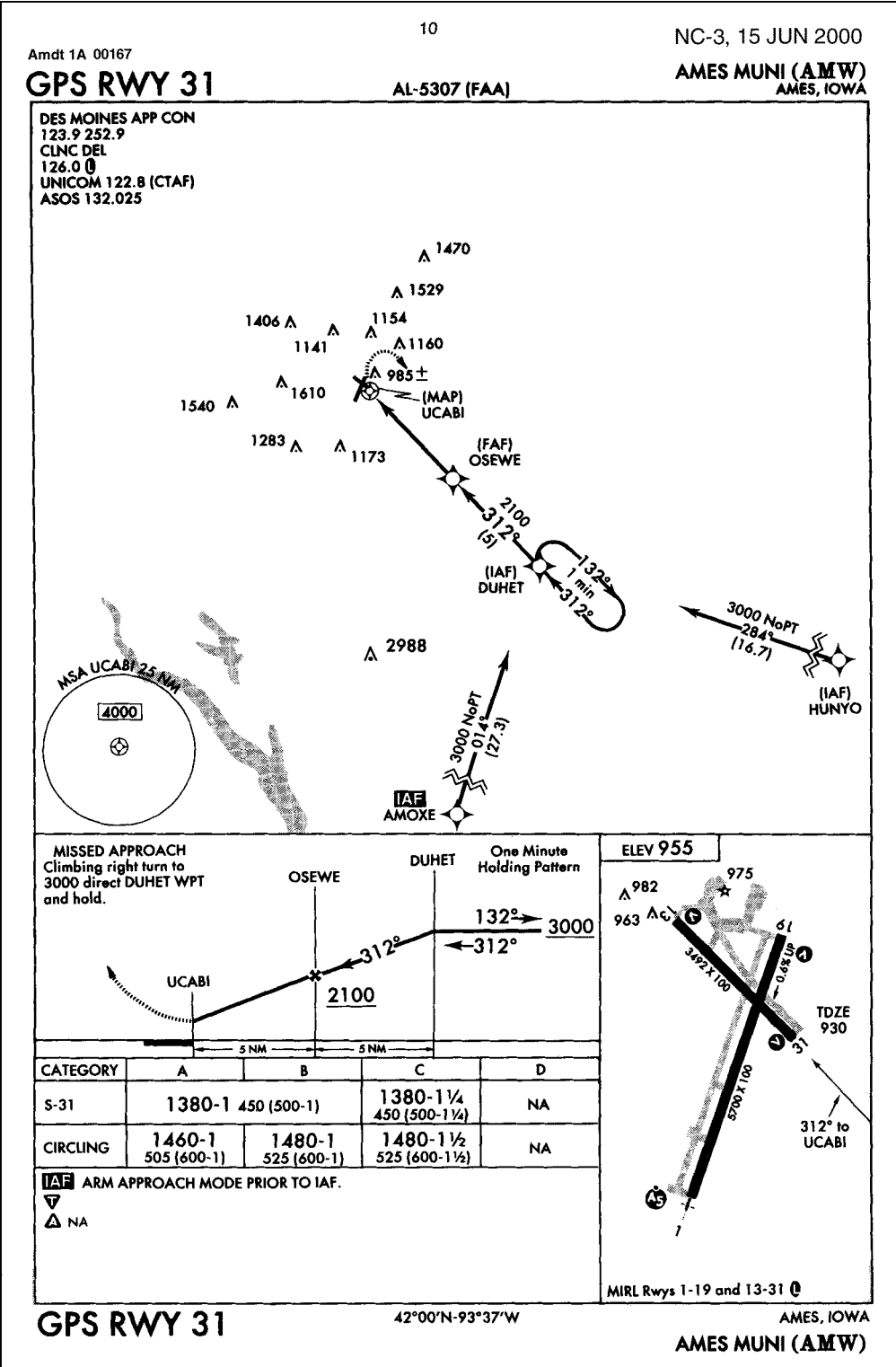
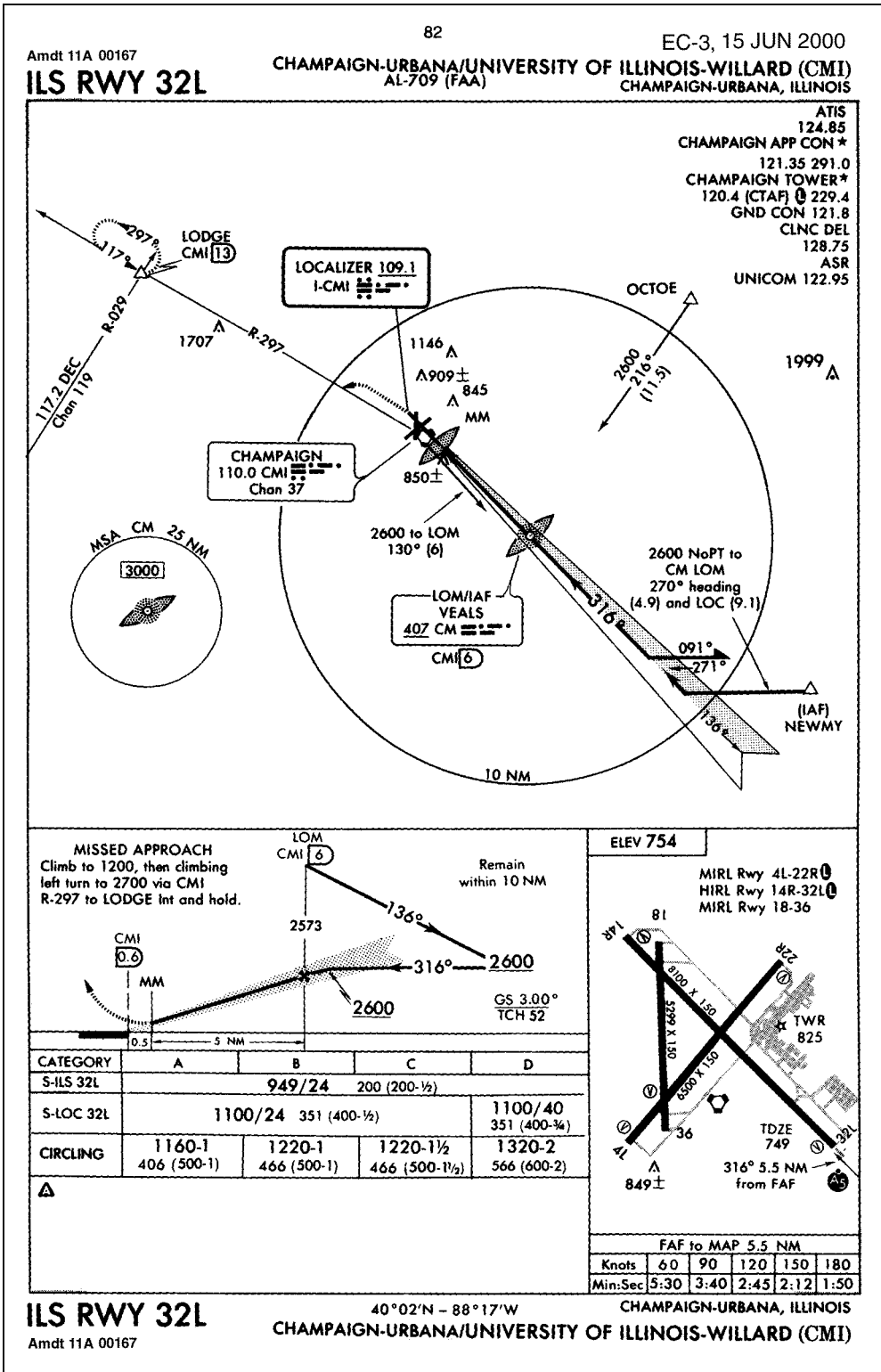


Figure 10-8. Ames, Iowa (AMW) GPS Rwy 31 approach: an approach procedure at an airport without an operating control tower.



### *Approach to an Airport With an Operating Tower, With an Approach Control*

Where radar is approved for approach control service, it is used to provide vectors in conjunction with published IAPs. Radar vectors can provide course guidance and expedite traffic to the final approach course of any established IAP.

Figure 10-9 shows an IAP chart with maximum ATC facilities available.

Approach control facilities that provide this radar service operate in the following manner:

1. Arriving aircraft are either cleared to an outer fix most appropriate to the route being flown with vertical separation and, if required, given holding information; or,
2. When radar hand-offs are effected between ARTCC and approach control, or between two approach control facilities, aircraft are cleared to the airport, or to a fix so located that the hand-off will be completed prior to the time the aircraft reaches the fix.
  - a. When the radar hand-offs are utilized, successive arriving flights may be handed-off to approach control with radar separation in lieu of vertical separation.
  - b. After hand-off to approach control, aircraft are vectored to the appropriate final approach course.
3. Radar vectors and altitude/flight levels will be issued as required for spacing and separating aircraft; therefore, you must not deviate from the headings issued by approach control.
4. You will normally be informed when it becomes necessary to vector you across the final approach course for spacing or other reasons. If you determine that approach course crossing is imminent and you have not been informed that you will be vectored across it, you should question the controller. You should not turn inbound on the final approach course unless you have received an approach clearance. Approach control will normally issue this clearance with the final vector for interception of the final approach course, and the vector will be such as to enable you to establish your aircraft on the final approach course prior to reaching the final approach fix. In the event you

are already inbound on the final approach course, you will be issued approach clearance prior to reaching the final approach fix.

5. After you are established inbound on the final approach course, radar separation will be maintained between you and other aircraft, and you will be expected to complete the approach using the NAVAID designated in the clearance (ILS, VOR, NDB, GPS, etc.) as the primary means of navigation.
6. After passing the final approach fix inbound, you are expected to proceed direct to the airport and complete the approach, or to execute the published **missed approach** procedure.
7. Radar service is automatically terminated when the landing is completed or the tower controller has your aircraft in sight, whichever occurs first.

### **Radar Approaches**

With a radar approach, the pilot is “talked down” while a controller monitors the progress of the flight with radar. This is an option should the pilot experience an emergency or distress situation. These approaches require a radar facility and a functioning airborne radio.

Initial radar contact for either a surveillance or **precision approach radar (PAR)** is made with approach control. Pilots must comply promptly with all instructions when conducting either type of procedure. They can determine the radar approach facilities (surveillance and/or precision) available at a specific airport by referring to the appropriate En route Low Altitude Chart and IAP chart. Surveillance and precision radar minimums are listed alphabetically by airport on pages with the heading, “Radar Instrument Approach Minimums,” in each TPP. Note that both straight-in and circling minimums are listed. [Figure 10-10]

When your instrument approach is being radar monitored, the radar advisories serve only as a secondary aid. Since you have selected a NAVAID such as the ILS or VOR as the primary aid for the approach, the minimums listed on the approach chart apply.

**Missed approach:** A maneuver conducted by a pilot when an instrument approach cannot be completed to a landing.

**Precision approach radar (PAR):** An instrument approach in which ATC issues azimuth and elevation instructions for pilot compliance, based on aircraft position in relation to the final approach course, glide slope, and distance from the end of the runway as displayed on the controller’s radar scope.



FORT HUACHUCA/SIERRA VISTA, AZ									
							Amdt. 20A, NOV 14, 1999		ELEV4716
SIERRA VISTA MUNI-LIBBY AAF									
RADAR 1 - 134.45 327.15									
	RWY	GS/TCH/RPI	CAT	DH/ MDA-VIS	HAT/ HAA CEIL-VIS	CAT	DH/ MDA-VIS	HAT/ HAA CEIL-VIS	
PAR	8		ABCDE	<b>4916</b> -¾	200 (200-¾)				
	26		ABCDE	<b>4826</b> -¾	200 (200-¾)				
ASR	26		ABCDE	<b>4900</b> -1	274 (200-1)				
CIRCLING			A	<b>5100</b> -1	384 (400-1)	B	<b>5180</b> -1	464 (500-1)	
			C	<b>5180</b> -1½	464 (500-1½)	DE	<b>5280</b> -2	564 (600-2)	
ASR	8		AB	<b>5440</b> -1	724 (800-1)	C	<b>5440</b> -2	724 (800-2)	
			D	<b>5440</b> -2½	724 (800-2½)	E	<b>5440</b> -2½	724 (800-2½)	
CIRCLING			AB	<b>5440</b> -1	724 (800-1)	C	<b>5440</b> -2	724 (800-2)	
			D	<b>5440</b> -2½	724 (800-2½)	E	<b>5440</b> -2½	724 (800-2½)	

PAR/ASR opr 1500-2300 Monday-Friday, except for holidays.  
 No NOTAM maintenance period 1500-1900 on the first Thursday of the month.  
 Circling not authorized south of runways 8 and 29.

▽  
 ▲ NA

SW-1

**RADAR INSTRUMENT APPROACH MINIMUMS**

**Figure 10-10.** Radar instrument approach minimums for Ft. Huachuca, AZ (FHU).

At a few FAA radar locations and military airfields, instrument approaches have been established on NAVAIDs whose final approach course from the final approach fix to the runway coincides with the PAR course. At such locations, your approach will be monitored and you will be given radar advisories whenever the reported weather is below basic VFR minimums (1,000 and 3), at night, or at your request. Before starting the final approach, you will be advised of the frequency on which the advisories will be transmitted. If for any reason radar advisories cannot be furnished, you will be advised.

*Surveillance Approach*

On an **airport surveillance radar approach (ASR)**, the controller will vector you to a point where you can begin a descent to the airport or to a specific runway. During the initial part of the approach, you will be given communications failure/missed approach instructions. Before you begin your descent, the controller will give you the published straight-in **minimum descent altitude (MDA)**. You will not be given the circling MDA unless you request it and tell the controller your aircraft category.

During the final approach, the controller will provide navigational guidance in azimuth only. Guidance in elevation is not possible, but you will be advised when to begin descent to the MDA, or if appropriate, to the intermediate “stepdown fix” MDA and subsequently to the prescribed MDA. In addition, you will be advised of the location of the missed approach point (MAP) and your position each mile from the runway, airport, or MAP as appropriate. If you so request, the controller will issue recommended altitudes each mile, based on the descent gradient established for the procedure, down to the last mile that is at or above the MDA.

You will normally be provided navigational guidance until you reach the MAP. The controller will terminate guidance and instruct you to execute a missed approach at the MAP, if at that point you do not have the runway or airport in sight, or if you are on a point-in-space approach in a helicopter, the prescribed visual reference with the surface is not established. If at any time during the approach the controller considers that safe guidance cannot be provided for the remainder of the approach, the approach will be terminated, and you will be instructed to execute a missed approach. Guidance termination and missed approach will be effected upon pilot request, and the controller may terminate guidance

**Airport surveillance radar approach (ASR):** An instrument approach in which ATC issues instructions for pilot compliance, based on aircraft position in relation to the final approach course, and the distance from the end of the runway as displayed on the controller’s radar scope.

**Minimum descent altitude (MDA):** The lowest altitude to which descent is authorized on final approach, or during circle-to-land maneuvering in execution of a nonprecision approach.

when the pilot reports the runway, airport/heliport, or visual surface route (point-in-space approach) in sight or otherwise indicates that continued guidance is not required. Radar service is automatically terminated at the completion of the radar approach.

### *Precision Approach*

The installations that have PAR are joint civil/military airports and usually provide service to civilian pilots flying IFR only with prior permission, except in an emergency.

A PAR serves the same purpose as an ILS, except that guidance information is presented to the pilot through aural rather than visual means. If a PAR is available, it is normally aligned with an ILS. During a PAR approach, pilots are provided highly accurate guidance in both azimuth and elevation.

The precision approach begins when your aircraft is within range of the precision radar and contact has been established with the PAR controller. Normally this occurs approximately 8 miles from touchdown, a point to which you are vectored by surveillance radar or are positioned by a nonradar approach procedure. You will be given headings to fly, to direct you to, and to keep your aircraft aligned with, the extended centerline of the landing runway.

Before intercepting the glidepath, you will be advised of communications failure/missed approach procedures and told not to acknowledge further transmissions. You will be told to anticipate glidepath interception approximately 15 to 30 seconds before it occurs and when to start your descent. The published **decision altitude/decision height (DA/DH)** will be given only if you request it.

During the final approach, the controller will give elevation information as “slightly/well above” or “slightly/well below” glidepath, and course information as “slightly/well right” or “slightly/well left” of course. Extreme accuracy in maintaining and correcting headings and rate of descent is essential. The controller will assume the last assigned heading is being maintained and will base further corrections on this assumption. Range from touchdown is given at least once each mile. If your aircraft is observed by the controller to proceed outside of specified safety zone limits in azimuth

**Decision altitude (DA):** A specified altitude in the precision approach, charted in “feet MSL,” at which a missed approach must be initiated if the required visual reference to continue the approach has not been established.

**Decision height (DH):** A specified altitude in the precision approach, charted in “height above threshold elevation,” at which a decision must be made to either continue the approach or to execute a missed approach.

and/or elevation and continue to operate outside these prescribed limits, you will be directed to execute a missed approach or to fly a specified course unless you have the runway environment in sight. You will be provided navigational guidance in azimuth and elevation to the DA/DH. Advisory course and glidepath information will be furnished by the controller until your aircraft passes over the runway threshold, at which point you will be advised of any deviation from the runway centerline. Radar service is automatically terminated at the completion of the approach.

### *No-Gyro Approach Under Radar Control*

If you should experience failure of your heading indicator or other stabilized compass, or for other reasons need more positive radar guidance, ATC will provide a no-gyro vector or approach on request. Before commencing such an approach, you will be advised as to the type of approach (surveillance or precision approach and runway number) and the manner in which turn instructions will be issued. All turns are executed at standard rate, except on final approach—then, at half-standard rate. The controller tells you when to start and stop turns, recommends altitude information and provides guidance and information essential for the completion of your approach. You can execute this approach in an emergency with an operating communications receiver and primary flight instruments.

### **Timed Approaches From a Holding Fix**

Timed approaches from a holding fix are conducted when many aircraft are waiting for an approach clearance. Although the controller will not specifically state “timed approaches are in progress,” the assigning of a time to depart the FAF inbound (nonprecision approach), or the outer marker or fix used in lieu of the outer marker inbound (precision approach), indicates that timed approach procedures are being utilized.

In lieu of holding, the controller may use radar vectors to the final approach course to establish a distance between aircraft that will ensure the appropriate time sequence between the FAF and outer marker, or fix used in lieu of the outer marker and the airport. Each pilot in the approach sequence will be given advance notice as to the time they should leave the holding point on approach to the airport. When a time to leave the holding point is received, the pilot should adjust the flightpath in order to leave the fix as closely as possible to the designated time.

Timed approaches may be conducted when the following conditions are met:

1. A control tower is in operation at the airport where the approaches are conducted.
2. Direct communications are maintained between the pilot and the Center or approach controller until the pilot is instructed to contact the tower.
3. If more than one missed approach procedure is available, none require a course reversal.
4. If only one missed approach procedure is available, the following conditions are met:
  - a. Course reversal is not required; and,
  - b. Reported ceiling and visibility are equal to or greater than the highest prescribed circling minimums for the IAP.
5. When cleared for the approach, pilots should not execute a procedure turn.

### **Approaches to Parallel Runways**

Procedures permit ILS instrument approach operations to dual or triple parallel runway configurations. Parallel approaches are an ATC procedure that permits parallel ILS approaches to airports with parallel runways separated by at least 2,500 feet between centerlines. Wherever parallel approaches are in progress, pilots are informed that approaches to both runways are in use.

Simultaneous approaches are permitted to runways:

1. With centerlines separated by 4,300 to 9,000 feet;
2. That are equipped with final monitor controllers;
3. That require radar monitoring to ensure separation between aircraft on the adjacent parallel approach course.

The approach procedure chart will include the note “simultaneous approaches authorized RWYS 14L and 14R,” identifying the appropriate runways. When advised that simultaneous parallel approaches are in progress, pilots must advise approach control immediately of malfunctioning or inoperative components.

Parallel approach operations demand heightened pilot situational awareness. The close proximity of adjacent aircraft

conducting simultaneous parallel approaches mandates strict compliance with all ATC clearances and approach procedures. Pilots should pay particular attention to the following approach chart information: name and number of the approach, localizer frequency, inbound course, glide-slope intercept altitude, DA/DH, missed approach instructions, special notes/procedures, and the assigned runway location and proximity to adjacent runways. Pilots also need to exercise strict radio discipline, which includes continuous monitoring of communications and the avoidance of lengthy, unnecessary radio transmissions.

### **Side-Step Maneuver**

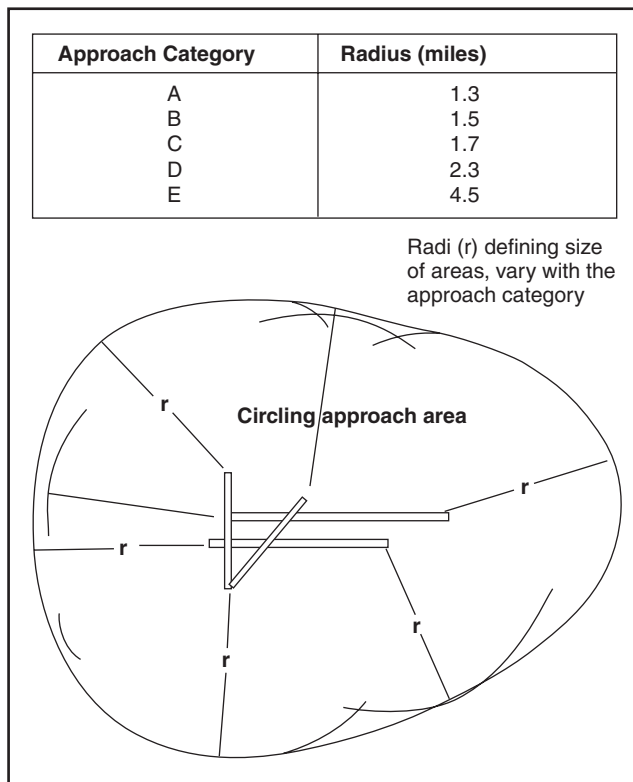
ATC may authorize a side-step maneuver to either one of two parallel runways that are separated by 1,200 feet or less, followed by a straight-in landing on the adjacent runway. Aircraft executing a side-step maneuver will be cleared for a specified nonprecision approach and landing on the adjacent parallel runway. For example, “Cleared ILS runway 7 left approach, side-step to runway 7 right.” Pilots are expected to commence the side-step maneuver as soon as possible after the runway or runway environment is in sight. Landing minimums to the adjacent runway will be based on nonprecision criteria and therefore higher than the precision minimums to the primary runway, but will normally be lower than the published circling minimums.

### **Circling Approaches**

Landing minimums are listed on the approach chart under “CIRCLING.” Circling minimums apply when it is necessary to circle the airport or maneuver for landing, or when no straight-in minimums are specified on the approach chart. [Figure 10-11]

The circling minimums published on the instrument approach chart provide a minimum of 300 feet of obstacle clearance in the circling area. During a **circling approach**, you should maintain visual contact with the runway of intended landing and fly no lower than the circling minimums until you are in position to make a final descent for a landing. Remember—circling minimums are just that—minimums. If the ceiling allows it, fly at an altitude that more nearly approximates your VFR traffic pattern altitude. This will make any maneuvering safer and bring your view of the landing runway into a more normal perspective.

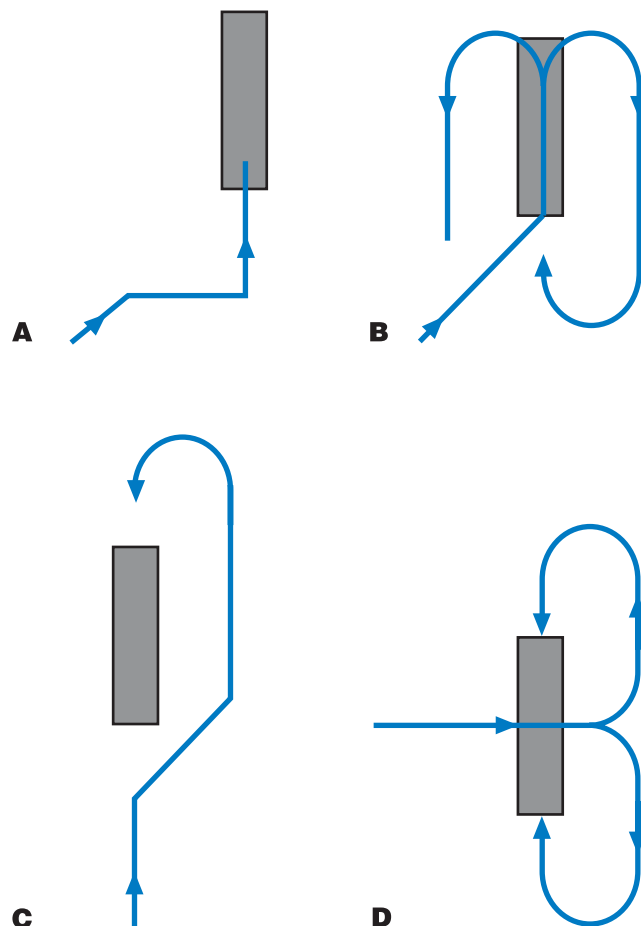
**Circling approach:** A maneuver initiated by the pilot to align the aircraft with a runway for landing when a straight-in landing from an instrument approach is not possible or is not desirable.



**Figure 10-11.** Circling approach area radii.

Figure 10-12 shows patterns that can be used for circling approaches. Pattern “A” can be flown when your final approach course intersects the runway centerline at less than a 90° angle, and you sight the runway early enough to establish a base leg. If you sight the runway too late to fly pattern “A,” you can circle as shown in “B.” You can fly pattern “C” if it is desirable to land opposite the direction of the final approach, and the runway is sighted in time for a turn to downwind leg. If the runway is sighted too late for a turn to downwind, you can fly pattern “D.” Regardless of the pattern flown, the pilot must maneuver the aircraft so as to remain within the designated circling area. Refer to section A (“Terms and Landing Minima Data”) in the front of each TPP, for a description of circling approach categories.

Sound judgment and knowledge of your capabilities and the performance of your aircraft are the criteria for determining the pattern to be flown in each instance, since you must consider all factors: airport design, ceiling and visibility, wind direction and velocity, final approach course alignment, distance from the final approach fix to the runway, and ATC instructions.



**Figure 10-12.** Circling approaches.

### IAP Minimums

Pilots may not operate an aircraft at any airport below the authorized MDA or continue an approach below the authorized DA/DH unless:

1. The aircraft is continuously in a position from which a descent to a landing on the intended runway can be made at a normal descent rate using normal maneuvers;
2. The flight visibility is not less than that prescribed for the approach procedure being used; and
3. At least one of the following visual references for the intended runway is visible and identifiable to the pilot:
  - a. Approach light system
  - b. Threshold
  - c. Threshold markings
  - d. Threshold lights

- e. Runway end identifier lights (REIL)
- f. Visual approach slope indicator (VASI)
- g. Touchdown zone or touchdown zone markings
- h. Touchdown zone lights
- i. Runway or runway markings
- j. Runway lights

### Missed Approaches

A missed approach procedure is formulated for each published instrument approach and allows the pilot to return to the airway structure while remaining clear of obstacles. The procedure is shown on the approach chart in text and graphic form. Since the execution of a missed approach occurs when your cockpit workload is at a maximum, the procedure should be studied and mastered before beginning the approach.

When a MAP is initiated, a climb pitch attitude should be established while setting climb power. You should configure the aircraft for climb, turn to the appropriate heading, advise ATC that you are executing a missed approach, and request further clearances.

If the missed approach is initiated prior to reaching the MAP, unless otherwise cleared by ATC, continue to fly the IAP as specified on the approach plate to the MAP at or above the MDA or DA/DH before beginning a turn.

If visual reference is lost while circling-to-land from an instrument approach, execute the appropriate MAP. You should make the initial climbing turn toward the landing runway and then maneuver to intercept and fly the missed approach course.

Pilots should immediately execute the missed approach procedure:

1. Whenever the requirements for operating below DA/DH or MDA are not met when the aircraft is below MDA, or upon arrival at the MAP and at any time after that until touchdown;
2. Whenever an identifiable part of the airport is not visible to the pilot during a circling maneuver at or above MDA;
3. When so directed by ATC.

### Missed Approach Caution

Acceleration forces and poor visual cues can cause sensory illusions during the execution of a missed approach. A well-developed instrument cross-check is necessary to safely carry out the procedure.

The missed approach procedures are related to the location of the FAF. When the FAF is not located on the field, the missed approach procedure will specify the distance from the facility to the MAP. The airport diagram on the IAP shows the time from the facility to the missed approach at various groundspeeds, which you must determine from airspeed, wind, and distance values. This time determines when you report and execute a missed approach if you do not have applicable minimums. Missed approach instructions will be provided prior to starting the final approach of either an ASR or PAR approach.

### Landing

According to part 91, no pilot may land when the flight visibility is less than the visibility prescribed in the standard IAP being used. ATC will provide the pilot with the current visibility reports appropriate to the runway in use. This may be in the form of **prevailing visibility**, **runway visual value (RVV)**, or **runway visual range (RVR)**. However, only the pilot can determine if the flight visibility meets the landing requirements indicated on the approach chart. If the flight visibility meets the minimum prescribed for the approach, then the approach may be continued to a landing. If the flight visibility is less than that prescribed for the approach, then the pilot must execute a missed approach, regardless of the reported visibility.

The landing minimums published on IAP charts are based on full operation of all components and visual aids associated with the instrument approach chart being used. Higher minimums are required with inoperative components or visual aids. For example, if the ALSF-1 approach lighting system were inoperative, the visibility minimums for an ILS must be increased by one-quarter mile. If more than one component is inoperative, each minimum is raised to the highest minimum required by any single component that is inoperative. ILS glide-slope inoperative minimums are published on instrument approach charts as localizer minimums. Consult the “Inoperative Components or Visual Aids Table” (printed on the inside front cover of each TPP), for a complete description of the effect of inoperative components on approach minimums.

**Prevailing visibility:** The greatest horizontal visibility equaled or exceeded throughout at least half the horizon circle (which is not necessarily continuous).

**Runway visibility value (RVV):** The visibility determined for a particular runway by a transmissometer.

**Runway visual range (RVR):** An instrumentally derived value, based on standard calibrations, that represents the horizontal distance a pilot will see down the runway from the approach end.

## Instrument Weather Flying

### Flying Experience

The more experience, the better — both VFR and IFR. Night flying promotes both instrument proficiency and confidence. Progressing from night flying under clear, moonlit conditions to flying without moonlight, natural horizon, or familiar landmarks, you learn to trust your instruments with a minimum dependence upon what you can see outside the aircraft. The more VFR experience you have in terminal areas with high traffic activity, the more capable you can become in dividing your attention between aircraft control, navigation, communications, and other cockpit duties. It is your decision to go ahead with an IFR flight or to wait for more acceptable weather conditions.

### Recency of Experience

Your currency as an instrument pilot is an equally important consideration. You may not act as pilot in command of an aircraft under IFR or in weather conditions less than VFR minimums unless you have met the requirements of part 61. Remember, these are minimum requirements. Whether they are adequate preparation for you, personally, is another consideration.

### Airborne Equipment and Ground Facilities

Regulations specify minimum equipment for filing an IFR flight plan. It is your responsibility to decide on the adequacy of your aircraft and navigation/communication (NAV/COM) equipment for the proposed IFR flight. Performance limitations, accessories, and general condition are directly related to the weather, route, altitude, and ground facilities pertinent to your flight, as well as to the cockpit workload you can expect.

### Weather Conditions

In addition to the weather conditions that might affect a VFR flight, an IFR pilot must consider the effects of other weather phenomena (e.g., thunderstorms, turbulence, icing, and visibility).

### Turbulence

In-flight turbulence can range from occasional light bumps to extreme airspeed and altitude variations in which aircraft control is difficult. To reduce the risk factors associated with

turbulence, pilots must learn methods of avoidance, as well as piloting techniques for dealing with an inadvertent encounter.

Turbulence avoidance begins with a thorough preflight weather briefing. Many reports and forecasts are available to assist the pilot in determining areas of potential turbulence. These include the Severe Weather Warning (WW), **SIGMET** (WS), **Convective SIGMET** (WST), **AIRMET** (WA), Severe Weather Outlook (AC), Center Weather Advisory (CWA), Area Forecast (FA), and Pilot Reports (UA or **PIREPs**). Since thunderstorms are always indicative of turbulence, areas of known and forecast thunderstorm activity will always be of interest to the pilot. In addition, clear air turbulence (CAT) associated with jet streams, strong winds over rough terrain, and fast moving cold fronts are good indicators of turbulence.

Pilots should be alert while in flight for the signposts of turbulence. For example, clouds with vertical development such as cumulus, towering cumulus, and cumulonimbus are indicators of atmospheric instability and possible turbulence. Standing lenticular clouds lack vertical development but indicate strong mountain wave turbulence. While en route, pilots can monitor hazardous in-flight weather advisory service (HIWAS) broadcast for updated weather advisories, or contact the nearest AFSS or En Route Flight Advisory Service (EFAS) for the latest turbulence-related PIREPs.

To avoid turbulence associated with strong thunderstorms, circumnavigate cells by at least 20 miles. Turbulence may also be present in the clear air above a thunderstorm. To avoid this, fly at least 1,000 feet above the tops for every 10 knots of wind at that level, or fly around the storm. Finally, do not underestimate the turbulence underneath a thunderstorm. Never attempt to fly under a thunderstorm even if you can see through to the other side. The possible results of turbulence and wind shear under the storm could be disastrous.

When you encounter moderate to severe turbulence, aircraft control will be difficult, and it will take a great deal of concentration to maintain an instrument scan. [Figure 10-13] Pilots should immediately reduce power and slow the aircraft to the recommended turbulence penetration speed as described in the POH/AFM. To minimize the load factor

**SIGMET:** A weather advisory issued concerning weather significant to the safety of all aircraft.

**Convective SIGMET:** Weather advisory concerning convective weather significant to the safety of all aircraft.

**AIRMET:** In-flight weather advisory issued as an amendment to the area forecast, concerning weather phenomena of operational interest to all aircraft which are potentially hazardous to aircraft with limited capability due to lack of equipment, instrumentation, or pilot qualifications.

**Pilot report (PIREP):** Report of meteorological phenomena encountered by aircraft in flight.

imposed on the aircraft, the wings should be kept level and the aircraft's pitch attitude should be held constant, while the altitude of the aircraft is allowed to fluctuate up and down. Maneuvering to maintain a constant altitude will only increase the stress on the aircraft. If necessary, the pilot should advise ATC of the fluctuations and request a block altitude clearance. In addition, the power should remain constant at a setting that will maintain the recommended turbulence penetration airspeed.



**Figure 10-13.** Maintaining an instrument scan in severe turbulence may be difficult.

The best source of information on the location and intensity of turbulence are PIREPs. Therefore, pilots are encouraged to familiarize themselves with the turbulence reporting criteria found in the AIM, which also describes the procedure for volunteering PIREPs relating to turbulence.

### Structural Icing

The very nature of IFR requires flight in visible moisture such as clouds. At the right temperatures, this moisture can freeze on the aircraft causing increased weight, degraded performance, and unpredictable aerodynamic characteristics. Understanding, avoidance, and early recognition followed by prompt action are the keys to avoiding this potentially hazardous situation.

Structural icing refers to the accumulation of ice on the exterior of the aircraft and is broken down into three classifications: **rime ice**, **clear ice**, and **mixed ice**. For ice to form,

**Rime ice:** Rough, milky, opaque ice formed by the instantaneous freezing of small supercooled water droplets.

**Clear ice:** Glossy, clear, or translucent ice formed by the relatively slow freezing of large supercooled water droplets.

there must be moisture present in the air, and the air must be cooled to a temperature of 0 °C (32 °F) or less. Aerodynamic cooling can lower the surface temperature of an airfoil and cause ice to form on the airframe even though the ambient temperature is slightly above freezing.

Rime ice forms if the droplets are small and freeze immediately when contacting the aircraft surface. This type of ice usually forms on areas such as the leading edges of wings or struts. It has a somewhat rough-looking appearance and a milky-white color.

Clear ice is usually formed from larger water droplets or freezing rain that can spread over a surface. This is the most dangerous type of ice since it is clear, hard to see, and can change the shape of the airfoil.

Mixed ice is a mixture of clear ice and rime ice. It has the bad characteristics of both types and can form rapidly. Ice particles become imbedded in clear ice, building a very rough accumulation. The table in figure 10-14 lists the temperatures at which the various types of ice will form.

Outside Air	Temperature Range	Icing Type
0 °C to	-10 °C	Clear
-10 °C to	-15 °C	Mixed clear and rime
-15 °C to	-20 °C	Rime

**Figure 10-14.** Temperature ranges for ice formation.

Structural icing is a condition that can only get worse. Therefore, during an inadvertent icing encounter, it is important the pilot act to prevent additional ice accumulation. Regardless of the level of **anti-ice** or **deice** protection offered by the aircraft, the first course of action should be to get out of the area of visible moisture. This might mean descending to an altitude below the cloud bases, climbing to an altitude that is above the cloud tops, or turning to a different course. If this is not possible, then the pilot must move to an altitude where the temperature is above freezing. Report icing conditions to ATC and request new routing or altitude if icing will be a hazard. Refer to the AIM for information on reporting icing intensities.

**Mixed ice:** A mixture of clear ice and rime ice.

**Deice:** System designed to remove ice accumulation from an aircraft structure.

**Anti-ice:** System designed to prevent the accumulation of ice on an aircraft structure.

## *Fog*

Instrument pilots must learn to anticipate conditions leading to the formation of fog and take appropriate action early in the progress of the flight. Before a flight, close examination of current and forecast weather should alert the pilot to the possibility of fog formation. When fog is a consideration, pilots should plan adequate fuel reserves and alternate landing sites. En route, the pilot must stay alert for fog formation through weather updates from EFAS, ATIS, and ASOS/AWOS sites.

Two conditions will lead to the formation of fog. Either the air is cooled to saturation, or sufficient moisture is added to the air until saturation occurs. In either case, fog can form when the temperature/dewpoint spread is 5° or less. Pilots planning to arrive at their destination near dusk with decreasing temperatures should be particularly concerned about the possibility of fog formation.

## *Volcanic Ash*

Volcanic eruptions create volcanic ash clouds containing an abrasive dust that poses a serious safety threat to flight operations. Adding to the danger is the fact that these ash clouds are not easily discernible from ordinary clouds when encountered at some distance from the volcanic eruption.

When an aircraft enters a volcanic ash cloud, dust particles and smoke may become evident in the cabin, often along with the odor of an electrical fire. Inside the volcanic ash cloud, the aircraft may also experience lightning and St. Elmo's fire on the windscreen. The abrasive nature of the volcanic ash can pit the windcreens, thus reducing or eliminating forward visibility. The pitot-static system may become clogged, causing instrument failure. Severe engine damage is probable in both piston and jet-powered aircraft.

Every effort must be made to avoid volcanic ash. Since volcanic ash clouds are carried by the wind, pilots should plan their flights to remain upwind of the ash-producing volcano. Visual detection and airborne radar are not considered a reliable means of avoiding volcanic ash clouds. Pilots witnessing volcanic eruptions or encountering volcanic ash should immediately pass this information along in the form of a pilot report. The National Weather Service monitors volcanic eruptions and estimates ash trajectories. This information is passed along to pilots in the form of SIGMETs.

Like many other hazards to flight, the best source of volcanic information comes from PIREPs. Pilots who witness a volcanic eruption or encounter volcanic ash in flight should immediately inform the nearest agency. Volcanic Ash Forecast Transport and Dispersion (VAFTAD) charts are also available; these depict volcanic ash cloud locations in the atmosphere following an eruption, and also forecast dispersion of the ash concentrations over 6- and 12-hour time intervals. *See AC 00-45, Aviation Weather Services.*

## *Thunderstorms*

A thunderstorm packs just about every weather hazard known to aviation into one vicious bundle. Turbulence, hail, rain, snow, lightning, sustained updrafts and downdrafts, and icing conditions are all present in thunderstorms. Do not take off in the face of an approaching thunderstorm or fly an aircraft that is not equipped with thunderstorm detection in clouds or at night in areas of suspected thunderstorm activity. [Figure 10-15]



**Figure 10-15.** A thunderstorm packs just about every weather hazard known to aviation into one vicious bundle.

### **Thunderstorm Avoidance**

Aircraft without airborne weather detection equipment should not operate in IMC near areas of suspected thunderstorm activity.



There is no useful correlation between the external visual appearance of thunderstorms and the severity or amount of turbulence or hail within them. All thunderstorms should be considered hazardous, and thunderstorms with tops above 35,000 feet should be considered extremely hazardous.

Weather radar, airborne or ground based, will normally reflect the areas of moderate to heavy precipitation (radar does not detect turbulence). The frequency and severity of turbulence generally increases with the radar reflectivity closely associated with the areas of highest liquid water content of the storm. A flightpath through an area of strong or very strong radar echoes separated by 20 to 30 miles or less may not be considered free of severe turbulence.

The probability of lightning strikes occurring to aircraft is greatest when operating at altitudes where temperatures are between -5 °C and +5 °C. In addition, an aircraft flying in the clear air near a thunderstorm is also susceptible to lightning strikes. Thunderstorm avoidance is always the best policy.

### Wind Shear

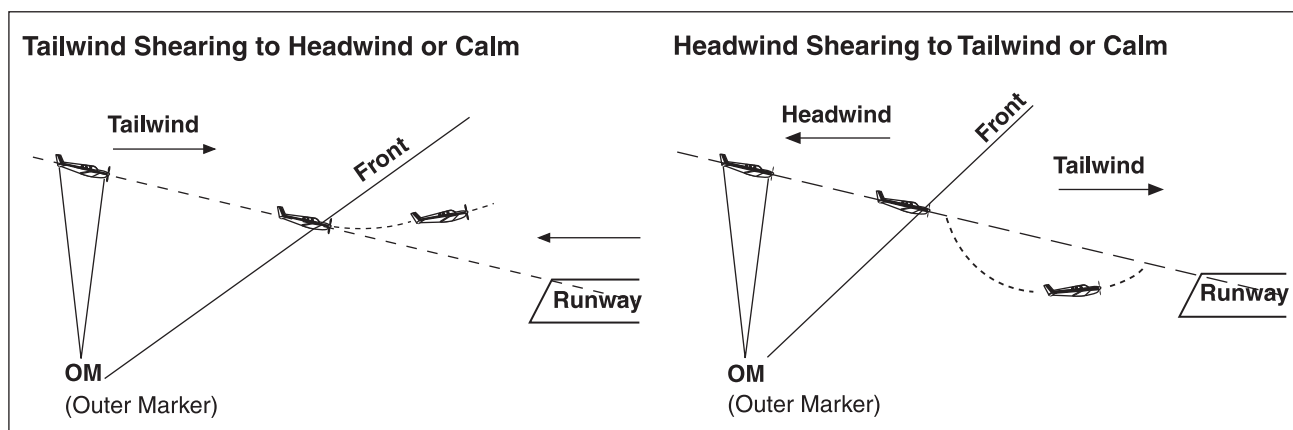
Wind shear can be defined as a change in wind speed and/or wind direction in a short distance. It can exist in a horizontal or vertical direction and occasionally in both. Wind shear can occur at all levels of the atmosphere but is of greatest concern during takeoffs and landings. It is typically associated with thunderstorms and low-level temperature inversions; however, the jet stream and weather fronts are also sources of wind shear.

As figure 10-16 illustrates, while an aircraft is on an instrument approach, a shear from a tailwind to a headwind will cause the airspeed to increase and the nose to pitch up with a corresponding balloon above the glidepath. A shear from a headwind to a tailwind will have the opposite effect and the aircraft will sink below the glidepath.

A headwind shear followed by a tailwind/downdraft shear is particularly dangerous because the pilot has reduced power and lowered the nose in response to the headwind shear. This leaves the aircraft in a nose-low, power-low configuration when the tailwind shear occurs, which makes recovery more difficult, particularly near the ground. This type of wind shear scenario is likely while making an approach in the face of an oncoming thunderstorm. Pilots should be alert for indications of wind shear early in the approach phase and be ready to initiate a missed approach at the first indication. It may be impossible to recover from a wind shear encounter at low altitude.

To inform pilots of hazardous wind shear activity, some airports have installed a Low-Level Wind Shear Alert System (LLWAS) consisting of a centerfield wind indicator and several surrounding boundary-wind indicators. With this system, controllers are alerted of wind discrepancies (an indicator of wind shear possibility) and provide this information to pilots. A typical wind shear alert issued to a pilot would be:

“Wind shear alert, Centerfield wind 230 at 8, south boundary wind 170 at 20.”



**Figure 10-16.** *Glide-slope deviations due to wind shear encounter.*

Pilots encountering wind shear are encouraged to pass along pilot reports. Refer to AIM for additional information on wind shear PIREPs.

### **VFR-On-Top**

Pilots on IFR flight plans operating in VFR weather conditions may request **VFR-On-Top** in lieu of an assigned altitude. This permits them to select an altitude or flight level of their choice (subject to any ATC restrictions).

Pilots desiring to climb through a cloud, haze, smoke, or other meteorological formation and then either cancel their IFR flight plan or operate VFR-On-Top may request a climb to VFR-On-Top. The ATC authorization will contain either a top report (or a statement that no top report is available), and a request to report upon reaching VFR-On-Top. Additionally, the ATC authorization may contain a clearance limit, routing, and an alternative clearance if VFR-On-Top is not reached by a specified altitude.

A pilot on an IFR flight plan, operating in VFR conditions, may request to climb/descend in VFR conditions. When operating in VFR conditions with an ATC authorization to “maintain VFR-On-Top/maintain VFR conditions” pilots on IFR flight plans must:

1. Fly at the appropriate VFR altitude as prescribed in part 91.
2. Comply with the VFR visibility and distance-from-cloud criteria in part 91.
3. Comply with IFRs applicable to this flight (e.g., minimum IFR altitudes, position reporting, radio communications, course to be flown, adherence to ATC clearance, etc.).

Pilots operating on a VFR-On-Top clearance should advise ATC before any altitude change to ensure the exchange of accurate traffic information.

ATC authorization to “maintain VFR-On-Top” is not intended to restrict pilots to operating only above an obscuring meteorological formation (layer). Rather, it permits operation above, below, between layers, or in areas where there is no meteorological obscuration. It is imperative pilots understand, however, that clearance to operate “VFR-On-Top/VFR conditions” does not imply cancellation of the IFR flight plan.

**VFR-On-Top:** ATC authorization for an IFR aircraft to operate in VFR conditions at any appropriate VFR altitude.

Pilots operating VFR-On-Top/VFR conditions may receive traffic information from ATC on other pertinent IFR or VFR aircraft. However, when operating in VFR weather conditions, it is the pilot’s responsibility to be vigilant to see-and-avoid other aircraft.

This clearance must be requested by the pilot on an IFR flight plan. VFR-On-Top is not permitted in certain areas, such as Class A airspace. Consequently, IFR flights operating VFR-On-Top must avoid such airspace.

### **VFR Over-The-Top**

**VFR Over-The-Top** must not be confused with VFR-On-Top. VFR-On-Top is an IFR clearance that allows the pilot to fly VFR altitudes. VFR Over-The-Top is strictly a VFR operation in which the pilot maintains VFR cloud clearance requirements while operating on top of an undercast layer. This situation might occur when the departure airport and the destination airport are reporting clear conditions, but a low overcast layer is present in between. The pilot could conduct a VFR departure, fly over the top of the undercast in VFR conditions, then complete a VFR descent and landing at the destination. VFR cloud clearance requirements would be maintained at all times, and an IFR clearance would not be required for any part of the flight.

## **Conducting an IFR Flight**

To illustrate some of the concepts introduced in this chapter, follow along on a typical IFR flight from the Detroit Metropolitan Airport (DTW) to the University of Illinois — Willard Airport located near Champaign, IL (CMI). [Figure 10-17] For this trip, a Cessna 182 with a call sign of N1230A will be flown. The aircraft is equipped with dual navigation and communication radios, DME, ADF, a transponder, and a GPS system approved for IFR en route operations to be used during the flight.

### **Preflight**

The success of the flight depends largely upon the thoroughness of the preflight planning. The evening before the flight, pay close attention to the weather forecast and begin planning the flight.

**VFR Over-The-Top:** A VFR operation in which an aircraft operates in VFR conditions on top of an undercast.

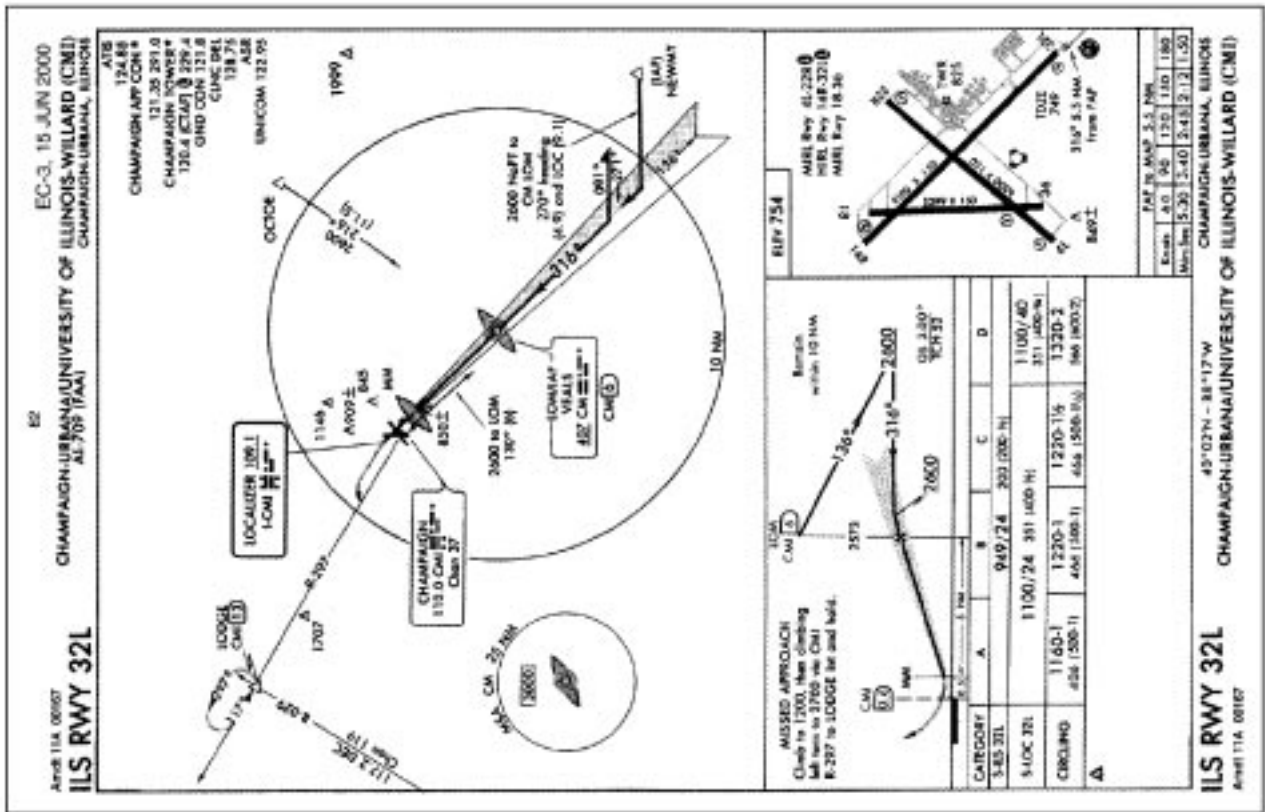


Figure 10-17. Route planning.

The Weather Channel indicates a large low-pressure system has settled in over the Midwest, pulling moisture up from the Gulf of Mexico and causing low ceilings and visibility, with little chance for improvement over the next couple of days. To begin planning, gather all the necessary charts and materials, and verify everything is current. This includes en route charts, approach charts, DPs, STAR charts, as well as an A/FD, some navigation logs, and the aircraft's POH/AFM. The charts cover both the departure and arrival airports, as well as any contingency airports that will be needed if you cannot complete the flight as planned. This is also a good time to consider your recent flight experience, proficiency as a pilot, fitness, and personal weather minimums to fly this particular flight.

To begin planning, go to the A/FD to become familiar with the departure and arrival airport and check for any preferred routing between DTW and CMI. Next, review the approach plates and any DP or STAR that pertain to the flight. Finally, review the en route charts for potential routing, paying close attention to the minimum en route and obstacle clearance altitudes.

After this review, you decide your best option is to fly the Palace Two DP (*see* figure 10-2) out of DTW direct to HARWL intersection, V116 to Jackson VOR (JXN), V221 to Litchfield VOR (LFD), then direct to CMI using the GPS. You also decide that an altitude of 4,000 feet will meet all the regulatory requirements and falls well within the performance capabilities of your aircraft.

Next, call 1-800-WX-BRIEF to obtain an outlook-type weather briefing for your proposed flight. This provides forecast conditions for your departure and arrival airports as well as the en route portion of the flight including forecast winds aloft. This also is a good opportunity to check the available NOTAMs.

The weather briefer confirms the predictions of the weather channel giving forecast conditions that are at or near minimum landing minimums at both DTW and CMI for your proposed departure time. The briefer also informs you of some NOTAM information for CMI indicating that the localizer back-course approach to runway 14 right is scheduled to be out of service for tomorrow, and that runway 4/22 is closed.

Somewhat leery of the weather, you continue flight planning and begin to transfer some preliminary information onto the navigation log, listing each fix along the route and the appropriate distances, frequencies, and altitudes. Consolidating this information onto an organized navigation log keeps your workload to a minimum during the flight. With your homework complete, now it is time to get a good night's sleep and see what tomorrow brings.

The next morning you awaken to light drizzle and low ceilings. You use the computer to print a standard weather briefing for the proposed route. A check of current conditions indicates low IFR conditions at both the departure airport and at the destination, with visibility of one-quarter mile:

#### SURFACE WEATHER OBSERVATIONS

METAR KDTW 111147Z VRB04KT 1/4SM FG -RN  
VV1600 06/05 A2944 RMK AO2 SLP970

METAR KCMI 111145Z 27006KT 1/4SM FG OVC001  
08/07 A2962 RMK AO2 SLP033

The small temperature/dewpoint spread is causing the low visibility and ceilings. As the temperatures increase, conditions should improve later in the day. A check of the terminal forecast confirms this theory:

#### TERMINAL FORECASTS

TAF KDTW 101146Z 101212 VRB04KT 1/4SM FG  
OVC001 TEMPO 1316 3/4SM VV1800

FM1600 VRB05KT 2SM BR OVC007 TEMPO 1720  
3SM DZ BKN009

FM2000 24008KT 3SM BR OVC015 TEMPO 2202  
3SM BR OVC025

FM0200 25010KT P6SM OVC025

FM0800 27013KT P6SM BKN030 PROB40 1012  
2SM -RN OVC030

TAF KCMI 101145Z 101212 2706KT 1/4SM FG  
VV1600 BECMG 1317 3SM BR OVC004

FM1700 2910KT 3SM BR OVC005

FM0400 2710KT 5SM SCT080 TEMPO 0612 P6SM  
SKC

In addition to the terminal forecast, the area forecast also indicates gradual improvement along the route. Since the terminal forecast only provides information for a 5-mile radius around a terminal area, checking the area forecast provides a better understanding of the overall weather picture along the route and alerts you to potential hazards:

SYNOPSIS AND VFR CLOUDS/WEATHER FORECASTS  
CHIC FA 111045

SYNOPSIS AND VFR CLDS/WX

SYNOPSIS VALID UNTIL 120500

CLDS/WX VALID UNTIL 112300...OTLK VALID  
112300-120500

ND SD NE KS MN IA MO WI LM LS MI LH IL IN  
KY

SEE AIRMET SIERRA FOR IFR CONDS AND MTN  
OBSCN.

TS IMPLY SEV OR GTR TURB SEV ICE LLWS AND  
IFR CONDS.

NON MSL HGTS DENOTED BY AGL OR CIG.

SYNOPSIS...AREA OF LOW PRESSURE CNTD OVR  
AL RMNG GENLY STNRY BRNGNG MSTR AND WD  
SPRD IFR TO GRT LKS RGN. ALF...LOW PRES  
TROF ACRS CNTR PTN OF THE CHI FA WILL  
GDLY MOV EWD DURG PD...KITE...

MO

CIG BKN020 TOPS TO FL180. VIS 1-3SM BR.  
SWLY WND. 18Z BRK030. OTLK...MVFR CIG.

WI LS LM MI LH IN

CIG OVC001-OVC006 TOPS TO FL240. VIS  
1/4-3/4SM FG. SWLY WND. 16Z CIG OVC010  
VIS 2SM BR. OCNL VIS 3-5SM -RN BR OVC009.  
OTLK...MVFR CIG VIS

IL

NRN 1/2 CIG OVC001 TOPS LYRD TO FL250.  
VIS 1/4-1SM FG BR. WLY WND THRUT THE PD.  
16Z CIG OVC006. SCT -SHRN. OTLK...IFR.  
SRN 1/2...CIG SCT-BKN015 TOPS TO FL250.  
WLY WND THRUT THE PD. 17Z AGL BRK040.  
OTLK...MVFR CIG VIS.

At this time, there are no SIGMETs or PIREPs reported. However, you note several AIRMETS, one for IFR conditions and one for turbulence that covers the entire route and another for icing conditions which covers an area just north of the route:

AIRMET TURB...MN WI MI LM IN IL IA MO OH  
FROM MSP TO TVC TO CLE TO FAM TO BUM TO  
MSP

OCNL MOD TURB BLW 080. CONDS CONTG BYD  
11Z THRU 17Z.

AIRMET ICE...WI MI MN

FROM MBS TO MSN TO INL TO AFW TO MBS  
LGT-OCNL MOD RIME ICGIC BTN 040 AND 100.  
CONDS CONTG BYD 11Z THRU 18Z.

FRZLVL...SFC-040 NRN MN SLPG 050-100 RMNDR  
FA AREA FM NW TO SE.

AIRMET IFR...IA MO IL IN WI LM LS MI LH  
MN

FROM INL TO AFW TO PIT TO BNA TO ICT TO  
INL

OCNL CIG BLW 010/VIS BLW 3SM PCPN/BR/FG.  
CONDS CONTG BYD 09Z THRU 15Z. RMNDR...NO  
WDSPRD IFR EXP.

A recheck of NOTAMs confirms that the localizer back-course approach for runway 14R at Champaign is out of service and that runway 22/4 is closed. You also learn of another NOTAM that was not mentioned in the telephone briefing, concerning the Palace-Two departure. If you use runway 21 for the departure, you should confirm that you are able to adhere to the climb restriction. This Palace-Two Departure NOTAM (below) is a good example of why it is important to check the second column of airport identifiers for the NOTAM location. If you only looked at the first column of identifiers, you might mistakenly think this NOTAM applied to USD rather than DTW:

USD 11/004 DTW PALACE TWO DEPARTURE: PROP  
AIRCRAFT DEPARTING RWY 21 WESTBOUND CROSS  
DXO 3.5 DME AT OR ABOVE 2500 MSL. IF  
UNABLE TO MAKE THE CLIMB RESTRICTION ADVISE  
DTW TOWER PRIOR TO DEPARTURE.

CMI 12/006 CMI RWY 22R/4L CLSD

CMI 12/008 CMI LOCBAC 14R OTS

# Flight Planner

## Preflight

TRUE COURSE	PLANNED ALTITUDE	PREDICTED WIND		TEMP	PLAN TAS	WIND CORR ANGLE -L +R	TRUE HEADING +E +W -E -W	MAG HEADING ± DEV	Checkpoints		AIRCRAFT N	TIME OFF	BLOCK START		BLOCK END
		DIRECTION	VELOCITY						DEPARTURE	ARRIVAL			SKY	TEMP	
275	4000	114	23	+02	140	-3L	272 +6	278 +2	DTW	K10	1308	1258	1455		
269	4000	116	23	+02	140	-4L	265 +5	270 +2	HARWL		1308	+8C	09008		
229	4000	116	23	+02	140	-9L	220 +5	225 +2	JXN		1308	3C	11		
236	4000	116	23	+02	140	-8L	228 +4	232 +2	LFD		1308				
									CMJ		1308				
									TOTALS		1308				
									ALTERNATE		1308				
230	4000	116	23	+02	140	-9L	221 +0	221 +2	CMJ		1308				
									ALN		1308				
									RESERVE		1308				

## Terminal Information

Field	Elevation	Runways	Radio Frequencies
DTW	640	3/21	133.67AHS 120.68 CLNC 119.456 (184M) 119.450EP
ALN	544	1/129	125.8 AHS 124.2 APA
CMJ	754	32L-14R	126.0T 120.2 GND 124.85 TFS 121.95 (A) 120.4 (T) 218 (G)

**Notes:** MINIMUM FUEL REQUIRED = 50 GALLONS  
 CMJ: LOC BAL 14R 05 RWY 22R/4L CLOSED

**Pilot Report**  
 FLIGHT WATCH 122.0  
 OR NEAREST  
 FLIGHT SERVICE  
 STATION

1 AIRCRAFT	2 POSITION	3 TIME (Z)	FLIGHT PLAN & WEATHER LOG ON REVERSE SIDE
	5 CLOUDS	6 ALTITUDE	



ASA-FP-2

Figure 10-18. Navigation log.

## Weather Briefing

LOCATION	TERMINAL AERODROME FORECASTS			
DTW	AFTER 8AM 70VC13 WIND 090@8			
CMI	AFTER 10AM 60VC14 WIND 140@9			
ALN	200VC13 WIND 140@8			
LOCATION	WINDS & TEMPERATURES ALOFT FORECASTS			
	ALT <u>3</u>	ALT <u>6</u>	ALT <u>9</u>	ALT _____
FWA	110@20	130@30	135@35	
LOCATION	PIREPS/SIGNIFICANT WEATHER/NOTAMS			
CMI	14R LOC BAC 05 RWY 22/4 CLSD			

Weight and Balance					
	WEIGHT	X	ARM	=	MOMENT
EMPTY WEIGHT AIRCRAFT	1802				139988
FRONT PASSENGERS	378		81		30618
REAR PASSENGERS	-		-		-
FUEL GAL x 6#/GAL=	420		95		39900
BAGGAGE	55		142		7810
TOTAL GROSS WEIGHT	2655		TOTAL MOMENT		218316
CG =	TOTAL MOMENT				
	TOTAL WEIGHT				82.2
GROSS WEIGHT AND CG WITHIN LIMITS? YES					

Figure 10-18. Navigation log. (continued)

The good news is that the weather is substantially better south of your route, making Alton Regional Airport a good alternate with current conditions and a forecast of marginal VFR.

METAR KALN 111049Z 25010KT 2SM BKN014  
OVC025 03/M03 A2973

TAF KSTL 101045Z 101212 2510KT 2SM BR  
OVC020 BECMG 1317 3SM BR OVC025

FM1700 2710KT 4SM BR OVC030

FM0400 2714KT 5SM OVC050 TEMPO 0612 P6SM  
OCV080

At this point, with weather minimums well below personal minimums, you make the decision to delay your departure for a couple of hours to wait for improved conditions; this gives you more time to continue with your preflight planning.

You can now complete your navigation log. [Figure 10-18] Use the POH/AFM to compute a true airspeed, cruise power setting, and fuel burn based on the forecast temperatures aloft and your cruising pressure altitude. Also, compute weight-and-balance information, and determine your takeoff and landing distance. You will have a slight tailwind if weather conditions require a straight-in landing on the ILS to runway 32L at CMI. Therefore, compute your landing distance assuming a 10-knot tailwind, and determine if the runway length is adequate to allow a downwind landing. Continuing in your navigation log, determine your estimated flight time and fuel burn using the winds aloft forecast and considering Alton, IL, as your alternate airport. With full tanks, you can make the flight nonstop, with adequate fuel for your destination, alternate, and a 1-hour and 10-minute reserve.

A look at the surface analysis chart provides the big picture and shows where you will find the pressure systems. The weather depiction chart shows areas of IFR conditions; you can use this to find areas of improving conditions. This is good information should you need to divert to VFR conditions. The radar depicts precipitation along the route, and the latest satellite photo confirms what the weather depiction chart showed.

With the navigation log finished, you can now complete the flight plan in preparation for filing with flight service. [Figure 10-19]

A couple of hours have passed, and a look out the window shows the weather appears to be improving. Calling AFSS for an update weather briefing, you learn that conditions have indeed improved. Detroit Metro airport is now 700 overcast with 3 miles visibility and Champaign is now 400 overcast with 2 miles visibility. The alternate, Alton Regional Airport, continues to report adequate weather conditions with 2,000 overcast and 3 miles visibility in light rain.

Several pilot reports have been submitted for light icing conditions; however, all the reports are north of the route of flight corresponding to the AIRMET that was issued earlier. You inquire about cloud tops, but the briefer states no pilot reports have included cloud tops, at this time; however, the area forecast was predicting cloud tops to flight level 240. Since the weather conditions appear to be improving and you have the weather briefer on the telephone, file your flight plan using the completed form.

U.S. DEPARTMENT OF TRANSPORTATION FEDERAL AVIATION ADMINISTRATION		(FAA USE ONLY) <input type="checkbox"/> PILOT BRIEFING <input type="checkbox"/> VNR			TIME STARTED		SPECIALIST INITIALS	
FLIGHT PLAN								
1. TYPE	2. AIRCRAFT IDENTIFICATION		3. AIRCRAFT TYPE/SPECIAL EQUIPMENT	4. TRUE AIRSPEED	5. DEPARTURE POINT		6. DEPARTURE TIME	
<input type="checkbox"/> VFR							PROPOSED (Z)	ACTUAL (Z)
<input checked="" type="checkbox"/> IFR	N1230A		C182/G	140 KTS	DTW		1300	
<input type="checkbox"/> DVFR								4000
8. ROUTE OF FLIGHT								
DCT LFD DCT CMI								
9. DESTINATION (Name of airport and city)			10. EST. TIME ENROUTE		11. REMARKS			
CMI-WILLARD AIRPORT SAVOY, IL			HOURS	MINUTES				
			01	42				
12. FUEL ON BOARD		13. ALTERNATE AIRPORT(S)		14. PILOT'S NAME, ADDRESS & TELEPHONE NUMBER & AIRCRAFT HOME BASE			15. NUMBER ABOARD	
HOURS	MINUTES			WARREN SMITH, 123 MAIN STREET DETROIT, MI 48123 217-555-1212 DTW				
04	20	ALN		17. DESTINATION CONTACT/TELEPHONE (OPTIONAL)			2	
16. COLOR OF AIRCRAFT			CIVIL AIRCRAFT PILOTS. FAR Part 91 requires you file an IFR flight plan to operate under instrument flight rules in controlled airspace. Failure to file could result in a civil penalty not to exceed \$1,000 for each violation (Section 901 of the Federal Aviation Act of 1958, as amended). Filing of a VFR flight plan is recommended as a good operating practice. See also Part 99 for requirements concerning DVFR flight plans.					
BLUE/WHITE								

FAA Form 7233-1 (8-82)

CLOSE VFR FLIGHT PLAN WITH \_\_\_\_\_ FSS ON ARRIVAL

**Figure 10-19.** Flight plan form.

Analyzing the latest weather, you decide to proceed with the trip. The weather minimums are now well above your personal minimums. With the absence of icing reported along the route and steadily rising temperatures, you are confident you will be able to avoid structural icing. However, make a note to do an operational check of the pitot heat during preflight and to take evasive action immediately should you encounter even light icing conditions in flight. This may require returning to DTW or landing at an intermediate spot before reaching CMI. Your go/no-go decision will be constantly reevaluated during the flight. With these thoughts you grab your flight bag and head for the airport.

At the airport you pull Cessna 1230A out of the hangar and conduct a thorough preflight inspection. A quick check of the logbooks indicates all airworthiness requirements have been met to conduct this IFR flight including an altimeter, static, and transponder test within the preceding 24-calendar months. In addition, a log on the clipboard indicates the VOR system has been checked within the preceding 30 days. Turn on the master switch and pitot heat, and quickly check the heating element before it becomes too hot. Then complete

the rest of the walk-around procedure. Since this will be a flight in actual IFR conditions, place special emphasis on IFR equipment during the walk-around, including the alternator belt and antennas. After completing the preflight, you organize your charts, pencils, paper, and navigation log in the cockpit for quick, easy access. You are ready to fly!

### Departure

After starting the engine, tune in ATIS and copy the information to your navigation log. The conditions remain the same as the updated weather briefing with the ceiling at 700 overcast, and visibility at 3 miles. Call clearance delivery, and receive your clearance:

“Departure Clearance, Cessna 1230A IFR to Champaign with information Kilo, ready to copy.”

“Cessna 1230A is cleared to Champaign via the PALACE 2 departure, HARWL, Victor 116 Jackson, Victor 221 Litchfield, then direct. Climb and maintain 4,000. Squawk 0321.”



Read back the clearance and review the DP. Although a departure frequency was not given in the clearance, you note that in the description of the DPs, it instructs propeller-driven aircraft to contact departure control frequency on 118.95. Since you are anticipating a departure from runway three center, you also note the instruction to climb to 1,100 prior to turning. The NOTAM received earlier applies only to runway 21 departures and will not be a factor. After tuning in the appropriate frequencies and setting up your navigation equipment for the departure routing, you contact ground control (noting that you are IFR), and receive the following clearance:

“Cessna 1230A taxi to runway 3 center via taxiways Sierra 4, Sierra, Foxtrot, and Mike. Hold short of runway 3 right at taxiway Foxtrot.”

Read back the clearance including the hold short instruction and your aircraft call sign. After a review of the taxi instructions on your airport diagram, begin your taxi and check your flight instruments for proper indications as you go. As you are holding short of runway three right at Foxtrot, ground control calls with the following clearance:

“Cessna 30A taxi to runway 3 center via Foxtrot and Mike.”

Continue taxi to runway three center and complete your before takeoff checklist and engine runup, then call the tower and advise them you are ready for takeoff. The tower gives the following clearance:

“Cessna 30A cleared for takeoff runway 3 center. Turn left heading 270. Caution wake turbulence for departing DC9.”

Taxi into position, note your time off on the navigation log, verify your heading indicator and magnetic compass are in agreement, the transponder is in the ALT position, all the necessary lights are on, and start the takeoff roll. Since you will be operating in the clouds, also turn on your pitot heat prior to departure. The takeoff roll will be substantially shorter than that of the DC9, so you are able to stay clear of its wake turbulence.

### **En Route**

After departure, climb straight ahead to 1,100 feet as directed by the Palace 2 Departure, then turn left to the assigned heading of 270 and continue your climb to 4,000 feet. As you roll out of the turn, tower contacts you:

“Cessna 30A contact Departure.”

Acknowledge the clearance and contact departure on the frequency designated by the DP. Provide your altitude so the departure controller can check your encoded altitude against your indicated altitude:

“Detroit Departure Cessna 1230A climbing through 2,700 heading 270.”

Departure replies:

“Cessna 30A proceed direct to HARWL intersection and resume your own navigation. Contact Cleveland Center on 125.45.”

Acknowledge the clearance, contact Cleveland Center, and proceed direct to HARWL intersection, using your IFR-approved GPS equipment, complete the appropriate checklists, and then on to Jackson and Litchfield VORs. At each fix you note your arrival time on the navigation log to monitor your progress. Upon reaching Litchfield VOR, proceed direct to CMI again using the GPS to navigate:

Cleveland replies:

“Cessna 30A radar contact. Fort Wayne altimeter 29.87. Traffic at your 2:00 position and 4 miles is a Boeing 727 descending to 5,000.”

Even when on an IFR flight plan, pilots are still responsible for seeing and avoiding other aircraft. Since you are in IFR conditions at the time the traffic advisory is issued, you should notify ATC:

“Roger, altimeter setting 29.87. Cessna 30A is in IMC.”

At this point you decide to get an update of the weather at the destination and issue a pilot report. To find the nearest AFSS, locate a nearby VOR and check above the VOR information box for a frequency. In this case, the nearest VOR is Goshen (GSH) which lists a receive-only frequency of 121.1. Request a frequency change from Cleveland Center and then attempt to contact Terre Haute 122.1 while listening over the Goshen VOR frequency of 113.7:

“Terre Haute Radio Cessna 1230A receiving on frequency 113.7, over.”

“Cessna 30A, this is Terre Haute, go ahead.”

“Terre Haute Radio, Cessna 30A is currently 20 miles southeast of the Goshen VOR at 4,000 feet en route to Champaign, IL. Requesting an update of en route conditions and current weather at CMI, as well as ALN.”

“Cessna 30A, Terre Haute Radio, current weather at Champaign is 300 overcast with 3 miles visibility in light rain. The winds are from 140 at 7 and the altimeter is 29.86. Weather across your route is generally IFR in light rain with ceilings ranging from 300 to 1,000 overcast with visibilities between 1 and 3 miles. Alton weather is much better with ceilings now at 2,500 and visibility 6 miles. Checking current NOTAMs at CMI shows the localizer back-course approach out of service and runway 4/22 closed.”

“Roger, Cessna 30A copies the weather. I have a PIREP when you are ready to copy.”

“Cessna 30A go ahead with your PIREP.”

“Cessna 30A is a Cessna 182 located on the Goshen 130 degree radial at 20 miles level at 4,000 feet. I am currently in IMC conditions with a smooth ride. Outside air temperature is plus 1-degree Celsius. Negative icing.”

“Cessna 30A thank you for your PIREP.”

With the weather check and PIREP complete, return to Cleveland Center:

“Cleveland Center, Cessna 30A is back on your frequency.”

“Cessna 30A, Cleveland Center roger, contact Chicago Center now on frequency 135.35.”

“Roger, contact Chicago Center frequency 135.35, Cessna 30A.”

“Chicago Center, Cessna 1230A level at 4,000 feet.”

“Cessna 30A, Chicago Center radar contact.”

A review of the weather provided by AFSS shows some deterioration of the CMI weather. In fact, the weather is right at your personal minimums. To further complicate matters, the only approach available is the ILS to runway 32L and the current weather does not allow for a circling approach. With the current winds at 140° and 7 knots, it means you will be flying the approach and landing with a tailwind. Re-evaluating your go/no-go decision, you decide to continue toward CMI. If the weather deteriorates further by the time you receive the CMI ATIS, you will proceed to the alternate of ALN which continues to report good weather.

Continuing toward Champaign, you discover a small trace of mixed ice beginning to form on the leading edge of the wing and notice the outside air temperature has dropped to 0 °C. You decide the best option is to climb to a higher altitude and request a climb to 5,000 feet from Chicago Center. Although this is the wrong altitude for your direction of flight, Chicago Center approves the request and you begin an immediate climb. Reaching 5,000 you are now between two cloud layers. A check of the outside air temperature shows a reading of 2 °C indicating a temperature inversion. Pass this information to Chicago Center in the form of a pilot report.

### **Arrival**

You are now approximately 50 miles northeast of CMI. Ask the Center controller for permission to leave the Center frequency, tune in the ATIS frequency, and you learn there has been no change in the weather since you talked to AFSS. ATIS is advertising ILS runway 32L as the active approach. After returning to Center, you begin reviewing the approach chart, placing special emphasis on the missed approach procedure. If the weather improves, you will want to circle for a landing on runway 14 right, so you should also review the circle to land minimums. You should complete the appropriate checklists.

Chicago Center hands you off to Champaign approach control and you contact approach:

“Champaign Approach, Cessna 1230A level 5,000 feet with information TANGO.”

“Cessna 30A, Champaign Approach, descend and maintain 3,000 feet, turn left heading 240 for radar vectors to the ILS approach to runway 32 left.”

“Descend to 3,000, turn left to 240, radar vectors to ILS 32L, Cessna 30A.”

Turn to 240° and begin your descent to 3,000. Since you are now on radar vectors, begin to configure your navigation radios for the approach. Tune in the ILS frequency of 109.1 on the number one navigation radio, and set in the final approach course of 316° on the OBS. Then set in the VOR frequency of 110.0 on your number two navigation radio, and set in the 297° radial on the OBS in anticipation of a missed approach. Finally, tune in the VEALS compass locator frequency of 407 on your ADF, identify each navigation signal, then tune in Champaign tower on your number two communication radio. You are ready to fly the approach when approach contacts you:

“Cessna 30A your position is 7 miles from VEALS, turn right heading 290 maintain 3,000 feet until intercepting the localizer, cleared for the ILS runway 32 left approach.”

Read back the clearance and concentrate on flying the aircraft. Intercept the localizer and descend to 2,600 as depicted on the approach chart. Champaign approach control hands you off to Champaign tower:

“Cessna 30A contact Tower on 120.4.”

“120.4, Cessna 30A.”

“Champaign Tower, Cessna 1230A outside VEALS on the ILS runway 32 left.”

“Cessna 30A Champaign Tower, the weather is improving at Champaign. The ceiling is now 600 overcast and the visibility is 4 miles. Plan to circle north of the field, cleared to land runway 14 right.”

“Circle north, cleared to land runway 14 right, Cessna 30A.”

Continue the approach, complete the appropriate checklists, cross the outer marker, and begin your descent on the glide slope. At 1,600 feet MSL you break out of the clouds and make visual contact with the airport. Even though circling minimums are 1,160 feet, you decide to conduct your circling approach at an altitude of 1,500 since the ceiling and visibility will allow it. You circle north of the field on a left downwind for runway 14 right and begin the descent abeam the touchdown to allow a normal descent to landing. As you touch down on the runway, Champaign Tower gives further instructions:

“Cessna 30A turn left at taxiway Bravo and taxi to the ramp on this frequency.”

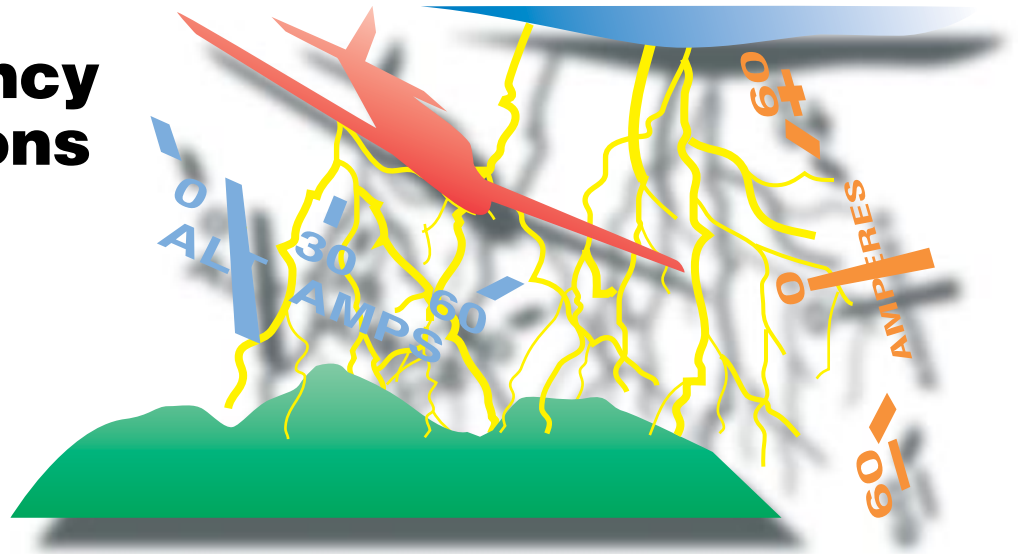
“Roger, Cessna 30A.”

As you taxi clear of the runway and complete the appropriate checklists, there is a great sense of accomplishment in having completed the flight successfully. Tower cancels your IFR flight plan with no further action on your part. Your thorough preflight planning has made this a successful trip.

### **Intercepting the Course**

If you are on a vector to intercept the localizer and the controller has not yet issued an approach clearance, do not proceed inbound upon localizer intercept, but do query the controller: “Cessna 1230 Alpha is intercepting.” The controller will then either issue the approach clearance or clarify why the flight is being vectored through the localizer.

# Emergency Operations



## Introduction

Changing weather conditions, air traffic control (ATC), the aircraft, and the pilot are all variables that make instrument flying an unpredictable and challenging operation. The safety of the flight depends upon the pilot's ability to manage these variables while maintaining positive aircraft control and adequate situational awareness. This chapter will discuss the recognition and suggested remedies for such abnormal and **emergency** events related to unforecasted, adverse weather, aircraft system malfunctions, communication/navigation system malfunctions, and loss of situational awareness.

## Unforecast Adverse Weather

### Inadvertent Thunderstorm Encounter

A pilot should avoid flying through a thunderstorm of any intensity. However, certain conditions may be present that could lead to an inadvertent thunderstorm encounter. For example, flying in areas where thunderstorms are embedded in large cloud masses may make thunderstorm avoidance difficult, even when the aircraft is equipped with thunderstorm detection equipment. Therefore, pilots must be prepared to deal with an inadvertent thunderstorm penetration. At the very least, a thunderstorm encounter will subject the aircraft to turbulence that could be severe. The pilot, as well as the passengers, should tighten seat belts and shoulder harnesses and secure any loose items in the cabin.

As with any emergency, the first order of business during an inadvertent thunderstorm encounter must be to fly the aircraft. The pilot workload will be high; therefore, increased concentration is necessary to maintain an instrument scan. Once you enter a thunderstorm, it is better to maintain a course straight through the thunderstorm rather than turning around. A straight course will most likely get you out of the hazard in the least amount of time, and turning maneuvers will only increase structural stress on the aircraft.

Reduce power to a setting that will maintain a speed at the recommended turbulence penetration speed as described in the Pilot's Operating Handbook/Airplane Flight Manual (POH/AFM), and try to minimize additional power adjustments. Concentrate on keeping the aircraft in a level attitude while allowing airspeed and altitude to fluctuate. Similarly, if using the autopilot, disengage the altitude hold and speed hold modes, as they will only increase the aircraft's maneuvering—thereby increasing structural stress.

During a thunderstorm encounter, the potential for icing also exists. As soon as possible, turn on anti-icing/deicing equipment and carburetor heat, if equipped. Icing can be rapid at any altitude and may lead to power failure and/or loss of airspeed indication.

Lightning will also be present in a thunderstorm and can temporarily blind a pilot. To reduce this risk, turn up cockpit lights to the highest intensity, concentrate on the flight instruments, and resist the urge to look outside.

**Emergency:** A distress or urgent condition.

## Inadvertent Icing Encounter

Because icing is unpredictable in nature, pilots may find themselves in icing conditions even though they have done everything to avoid it. In order to stay alert to this possibility while operating in visible moisture, pilots should monitor the outside air temperature (OAT).

Proper utilization of the anti-icing/deicing equipment is critical to the safety of the flight. If the anti-icing/deicing equipment is used before sufficient ice has accumulated, the equipment may not be able to remove all of the ice accumulation. Refer to the POH/AFM for the proper use of anti-icing/deicing equipment.

Prior to entering visible moisture with temperatures at 5° above freezing or cooler, activate the appropriate anti-icing/deicing equipment in anticipation of ice accumulation—early ice detection is critical. This may be particularly difficult during night flight. You may need to use a flashlight to check for ice accumulation on the wings. At the first indication of ice accumulation, you must act to get out of the icing conditions.

There are four options for action once ice has begun to accumulate on the aircraft:

1. Move to an altitude with significantly colder temperatures;
2. Move to an altitude with temperatures that are above freezing;
3. Fly to an area clear of visible moisture; or
4. Change heading and fly to an area of known nonicing conditions.

If none of these options are available, you must consider an immediate landing at the nearest suitable airport. Anti-icing/deicing equipment is not designed to allow aircraft to operate in icing conditions indefinitely. Anti-icing/deicing equipment will simply give you more time to get out of the icing conditions.

## Precipitation Static

**Precipitation static**, often referred to as P-static, occurs when accumulated static electricity is discharged from the extremities of the aircraft. This discharge has the potential to create problems for the instrument pilot. These problems range from the serious, such as the complete loss of very-high

**Precipitation static:** A form of radio interference caused by rain, snow, or dust particles hitting the antenna and inducing a small radio-frequency voltage into it.

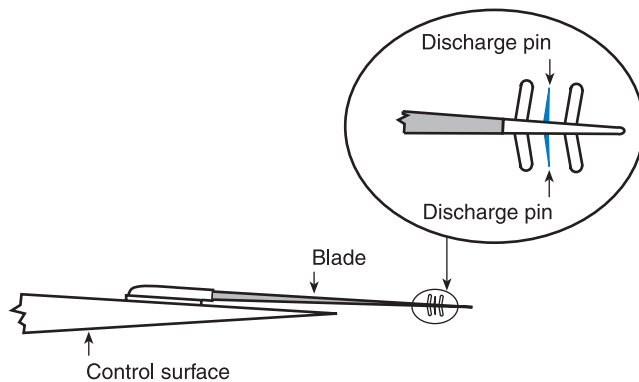
frequency (VHF) communications and erroneous magnetic compass readings, to the annoyance of high-pitched audio squealing, and **St. Elmo's Fire**. [Figure 11-1]



**Figure 11-1.** *St. Elmo's Fire.*

Precipitation static is caused when an aircraft encounters airborne particles during flight (e.g., rain or snow), and develops a negative charge. It can also result from atmospheric electric fields in thunderstorm clouds. When a significant negative voltage level is reached, the aircraft will discharge it, which can create electrical disturbances.

To reduce the problems associated with P-static, the pilot should ensure the aircraft's static wicks are properly maintained and accounted for. Broken or missing static wicks should be replaced before an instrument flight. [Figure 11-2]



**Figure 11-2.** *One example of a static wick installed on aircraft control surface to bleed off static charges built up during flight.*

**St. Elmo's Fire:** A corona discharge which lights up the aircraft surface areas where maximum static discharge occurs.

## Aircraft System Malfunctions

Preventing aircraft system malfunctions that might lead to an inflight emergency begins with a thorough preflight inspection. In addition to those items normally checked prior to a visual flight rule (VFR) flight, pilots intending to fly under instrument flight rules (IFR) should pay particular attention to the alternator belt, antennas, static wicks, anti-icing/deicing equipment, pitot tube, and static ports.

During taxi, verify the operation and accuracy of all flight instruments. In addition, during the runup, verify that the operation of the pneumatic system is within acceptable parameters. It is critical that all systems are determined to be operational before departing into IFR conditions.

### Alternator/Generator Failure

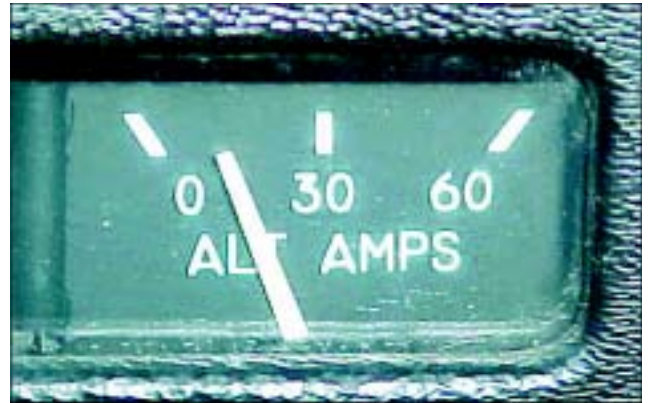
Depending upon the aircraft being flown, an alternator failure is indicated in different ways. Some aircraft use an **ammeter** that indicates the state of charge or discharge of the battery. [Figure 11-3] A positive indication on the ammeter indicates a charge condition; a negative indication reveals a discharge condition. Other aircraft use a **loadmeter** to indicate the load being carried by the alternator. [Figure 11-4] If the alternator were to fail, then a zero load indication is shown on the loadmeter. Sometimes an indicator light is also installed in the aircraft to alert the pilot to an alternator failure. Review the appropriate POH/AFM for information on the type of systems installed in your aircraft.



**Figure 11-3.** *Ammeter.*

**Ammeter:** An instrument installed in series with an electrical load to measure the amount of current flowing through the load.

**Loadmeter:** A type of ammeter installed between the generator output and the main bus in an aircraft electrical system.



**Figure 11-4.** *Loadmeter.*

Once an alternator failure has been detected, the pilot must reduce the electrical load on the battery and land as soon as practical. Depending upon the electrical load and condition of the battery, there may be sufficient power available for an hour or more of flight—or for only a matter of minutes. You should also be familiar with what systems on the aircraft are electric and which continue to operate without electrical power. The pilot can attempt to troubleshoot the alternator failure by following the established alternator failure procedure published in the POH/AFM. If the alternator cannot be reset, advise ATC of the situation and inform them of the impending electrical failure.

### Instrument Failure

System or instrument failure is usually identified by a warning indicator or an inconsistency between the indications on the attitude indicator and the supporting performance instruments. Aircraft control must be maintained while identifying the failed component(s). Expedite the cross-check and include all the flight instruments. The problem may be individual instrument failure or a system failure that affects several instruments.

One method of identification involves an immediate comparison of the attitude indicator with the rate-of-turn indicator and vertical speed indicator (VSI). Along with providing pitch-and-bank information, this technique compares the static system with the suction or pressure system and the electrical system. Identify the failed component(s) and use the remaining functional instruments to maintain aircraft control.

Attempt to restore the inoperative component(s) by checking the appropriate power source, changing to a backup or alternate system, and resetting the instrument if possible. Covering the failed instrument(s) may enhance your ability to maintain aircraft control and navigate the aircraft. Usually the next step is to advise ATC of the problem and, if necessary, declare an emergency before the situation deteriorates beyond your ability to recover.

### Pneumatic System Failure

One possible cause of instrument failure is a loss of the suction or pressure source. This pressure or suction is supplied by a vacuum pump mechanically driven off the engine. Occasionally, these pumps fail, leaving the pilot with inoperative attitude and heading indicators. [Figure 11-5] Many small aircraft are not equipped with a warning system for vacuum failure; therefore, the pilot should monitor the system's vacuum/pressure gauge. This can be a hazardous situation with the potential to lead the unsuspecting pilot into a dangerous unusual attitude—which would require a partial panel recovery. It is important pilots practice instrument flight without reference to the attitude and heading indicators in preparation for such a failure.

### Pitot/Static System Failure

A pitot or static system failure can also cause erratic and unreliable instrument indications. When a static system problem occurs, it will affect the airspeed indicator, altimeter, and the VSI. In most aircraft, provisions have been made for the pilot to select an alternate static source. Check the POH/AFM for the location and operation of the alternate static source. In the absence of an alternate static source, in an unpressurized aircraft, the pilot could break the glass on the VSI. The VSI is not required for instrument flight and breaking the glass will provide the altimeter and the airspeed indicator a source of static pressure. This procedure could cause additional instrument errors.

### Communication/Navigation System Malfunction

Avionics equipment has become very reliable, and the likelihood of a complete communications failure is remote. However, each IFR flight should be planned and executed in anticipation of a two-way radio failure. At any given point during a flight, the pilot must know exactly what route to fly, what altitude to fly, and when to continue beyond a **clearance limit**. Title 14 of the Code of Federal Regulations (14 CFR) part 91 describes the procedures to be followed in case of a two-way radio communications failure. If the pilot is operating



Figure 11-5. Vacuum failure—inoperative attitude and heading indicators.

**Clearance limit:** The fix, point, or location to which an aircraft is cleared when issued an air traffic clearance.

in VFR conditions at the time of the failure, the pilot should continue the flight under VFR and land as soon as practicable. If the failure occurs in IFR conditions, or if VFR conditions cannot be maintained, the pilot must continue the flight:

1. Along the route assigned in the last ATC clearance received;
2. If being radar vectored, by the direct route from the point of radio failure to the fix, route, or airway specified in the vector clearance;
3. In the absence of an assigned route, by the route that ATC has advised may be expected in a further clearance; or
4. In the absence of an assigned route or a route that ATC has advised may be expected in a further clearance, by the route filed in the flight plan.

The pilot should maintain the highest of the following altitudes or flight levels for the route segment being flown:

1. The altitude or flight level assigned in the last ATC clearance received;
2. The minimum altitude (converted, if appropriate, to minimum flight level as prescribed in part 91 for IFR operations); or
3. The altitude or flight level ATC has advised may be expected in a further clearance.

In addition to route and altitude, the pilot must also plan the progress of the flight to leave the clearance limit:

1. When the clearance limit is a fix from which an approach begins, commence descent or descent and approach as close as possible to the expect-further-clearance time if one has been received; or if one has not been received, as close as possible to the estimated time of arrival as calculated from the filed or amended (with ATC) estimated time en route.
2. If the clearance limit is not a fix from which an approach begins, leave the clearance limit at the expect-further-clearance time if one has been received; or if none has been received, upon arrival over the clearance limit, and proceed to a fix from which an approach begins and commence descent or descent and approach as close as possible to the estimated time of arrival as calculated from the filed or amended (with ATC) estimated time en route.

While following these procedures, set the transponder to code 7600 and use all means possible to re-establish two-way radio communication with ATC. This includes monitoring navigational aids (NAVAIDs), attempting radio contact with other aircraft, and attempting contact with a nearby automated flight service station (AFSS).

### **Loss of Situational Awareness (SA)**

Situational awareness (SA) is not simply a mental picture of where you are; rather, it is an overall assessment of each element of the environment and how it will affect your flight. On one end of the SA spectrum is a pilot who is knowledgeable of every aspect of the flight; consequently, this pilot's decision making is proactive. With good SA, this pilot is able to make decisions well ahead of time and evaluate several different options. On the other end of the SA spectrum is a pilot who is missing important pieces of the puzzle: "I knew exactly where I was when I ran out of fuel." Consequently, this pilot's decision making is reactive. With poor SA, this pilot lacks a vision of future events and is forced to make decisions quickly, often with limited options.

During a typical IFR flight, a pilot will operate at varying levels of SA. For example, a pilot may be cruising to his/her destination with a high level of SA when ATC issues an unexpected standard terminal arrival route (STAR). Since the pilot was not expecting the STAR and is not familiar with it, SA is lowered. However, after becoming familiar with the STAR and resuming normal navigation, the pilot returns to a higher level of SA.

Factors that reduce SA include: distractions, unusual or unexpected events, complacency, high workload, unfamiliar situations, and inoperative equipment. In some situations, a loss of SA may be beyond a pilot's control. For example, with a pneumatic system failure and associated loss of the attitude and heading indicators, a pilot may find his/her aircraft in an unusual attitude. In this situation, established procedures must be used to regain SA.

As a pilot, you should be alert to a loss of SA any time you find yourself in a reactive mindset. To regain SA, you must re-assess your situation and work toward understanding. This may mean you need to seek additional information from other sources, such as the navigation instruments or ATC.





# Appendix 1

## Clearance Shorthand

The following shorthand system is recommended by the Federal Aviation Administration (FAA). Applicants for the Instrument Rating may use any shorthand system, in any language, which ensures accurate compliance with air traffic control (ATC) instructions. No shorthand system is required by regulation and no knowledge of shorthand is required for the FAA Knowledge Test; however, because of the vital need for reliable communication between the pilot and controller, clearance information should be unmistakably clear.

The following symbols and contractions represent words and phrases frequently used in clearances. Most of them are used regularly by ATC personnel. By practicing this shorthand, omitting the parenthetical words, you will be able to copy long clearances as fast as they are read.





Example: CAF ~~M~~→ RH RV V18 <sup>↑</sup>40 SQ 0700 DPC 120.4  
 Cleared as filed, maintain runway heading for radar vector to Victor 18, climb to 4,000, squawk 0700, departure control frequency is 120.4.

### Words and Phrases

### Shorthand

Above .....	ABV
Above (Altitude, Hundreds of Feet) .....	70
Adjust speed to 250 knots .....	250 K
Advise .....	ADZ
After (Passing) .....	<
Airway (Designation) .....	V26
Airport .....	A
Alternate Instructions .....	( )
Altitude 6,000-17,000 .....	60-170
And .....	&
Approach .....	AP
Approach Control .....	APC
Area Navigation .....	RNAV

Arriving .....	↓
At .....	@
At or Above .....	↑
At or Below .....	↓
(ATC) Advises .....	CA
(ATC) Clears or Cleared .....	C
(ATC) Requests .....	CR
Back Course .....	BC
Bearing .....	BR
Before (Reaching, Passing) .....	>
Below .....	BLO
Below (Altitude, Hundreds of Feet) .....	70
Center .....	CTR
Clearance Void if Not Off By (time) .....	v<
Cleared as Filed .....	CAF
Cleared to Airport .....	A
Cleared to Climb/Descend at Pilot's Discretion .....	PD
Cleared to Cross .....	X
Cleared to Depart From the Fix .....	D
Cleared to the Fix .....	F
Cleared to Hold and Instructions Issued .....	H
Cleared to Land .....	L
Cleared to the Outer Marker .....	O
Climb to (Altitude, Hundreds of Feet) .....	↑ 70
Contact Approach .....	CT
Contact (Denver) Approach Control .....	(den
Contact (Denver) Center .....	(DEN
Course .....	CRS

Cross .....	X	ILS Approach .....	ILS
Cruise .....	→	Increase Speed 30 Knots .....	+30 K
Delay Indefinite .....	DLI	Initial Approach .....	I
Depart (direction, if specified) .....	T→ ( )	Instrument Departure Procedure .....	DP
Departure Control .....	DPC	Intersection .....	XN
Descend To (Altitude, Hundreds of Feet) .....	↓70	Join or Intercept Airway/ Jet Route/Track or Course .....	∩
Direct .....	DR	Left Turn After Takeoff .....	↶
Direction (Bound)		Locator Outer Marker .....	LOM
Eastbound .....	EB	Magnetic .....	M
Westbound .....	WB	Maintain .....	M→
Northbound .....	NB	Maintain VFR Conditions On Top .....	<u>VFR</u>
Southbound .....	SB	Middle Compass Locator .....	ML
Inbound .....	IB	Middle Marker .....	MM
Outbound .....	OB	Missed Approach .....	MA
DME Fix (Mile) .....		Nondirectional Beacon Approach .....	NDB
Each .....	EA	Out of (Leave) Control Area .....	
Enter Control Area .....		Outer Marker .....	OM
Estimated Time of Arrival .....	ETA	Over (Station) .....	<u>OKC</u>
Expect .....	EX	On Course .....	OC
Expect-Further-Clearance .....	EFC	Precision Approach Radar .....	PAR
Fan Marker .....	FM	Procedure Turn .....	PT
Final .....	F	Radar Vector .....	RV
Final Approach .....	FA	Radial (080° Radial) .....	080R
Flight Level .....	FL	Reduce Speed 20 Knots .....	-20 K
Flight Planned Route .....	FPR	Remain This Frequency .....	RTF
For Further Clearance .....	FFC	Remain Well to Left Side .....	LS
For Further Headings .....	FFH	Remain Well to Right Side .....	RS
From .....	FM	Report Crossing .....	RX
Ground .....	GND	Report Departing .....	RD
GPS Approach .....	GPS	Report Leaving .....	RL
Heading .....	HDG	Report on Course .....	R-CRS
Hold (Direction) .....	H-W	Report Over .....	RO
Holding Pattern .....			

Report Passing .....	RP	Turn Left .....	TL
Report Reaching .....	RR	Turn Right .....	TR
Report Starting Procedure Turn .....	RSPT	Until .....	/
Reverse Course .....	RC	Until Advised (By) .....	UA
Right Turn After Takeoff .....	↷	Until Further Advised .....	UFA
Runway Heading .....	RH	VFR Conditions On Top .....	OTP
Runway (Number) .....	RY18	Via .....	VIA
Squawk .....	SQ	Victor (Airway Number) .....	V14
Standby .....	STBY	Visual Approach .....	VA
Straight-in Approach .....	SI	VOR .....	⊙
Surveillance Radar Approach .....	ASR	VOR Approach .....	VR
Takeoff (Direction) .....	T→N	VORTAC .....	⊕
Tower .....	Z	While in Control Area .....	△



# Appendix 2

## *Instrument Training Lesson Guide*

### **Introduction**

Flight instructors may use this guide in the development of lesson plans. The lessons are arranged in a logical learning sequence and use the building-block technique. Each lesson includes ground training appropriate to the flight portion of the lesson. It is vitally important that the flight instructor brief the student on the objective of the lesson and how it will be accomplished. Debriefing the student's performance is also necessary to motivate further progress. To ensure steady progress, student pilots should master the objective of each lesson before advancing to the next lesson. Lessons should be arranged to take advantage of each student's knowledge and skills.

Flight instructors must monitor progress closely during training to guide student pilots in how to properly divide their attention. The importance of this division of attention or "cross-check" cannot be overemphasized. Cross-check and proper instrument interpretation are essential components of "attitude instrument flying" that enables student pilots to accurately visualize the aircraft's attitude at all times.

When possible, each lesson should incorporate radio communications, basic navigation, and emergency procedures so the student pilot is exposed to the entire IFR experience with each flight. Cross-reference the Instrument Training Lesson Guide with this handbook and the Instrument Practical Test Standards for a comprehensive instrument rating training program.

### **Lesson 1—Ground and flight evaluation of student's knowledge and performance**

- Aircraft systems
- Aircraft performance
- Preflight planning
- Use of checklists
- Basic flight maneuvers
- Radio communications procedures
- Navigation systems

### **Lesson 2—Preflight preparation and flight by reference to instruments**

#### **Ground Training**

- Instrument system preflight procedures
- Attitude instrument flying
- Fundamental instrument skills
- Instrument cross-check techniques

#### **Flight Training**

- Aircraft and instrument preflight inspection
- Use of checklists
- Fundamental instrument skills
- Basic flight maneuvers
- Instrument approach (demonstrated)
- Postflight procedures

### **Lesson 3—Flight instruments and human factors**

#### **Ground Training**

- Human factors
- Flight instruments and systems
- Aircraft systems
- Navigation instruments and systems

#### **Flight Training**

- Aircraft and instrument preflight inspection
- Radio communications
- Checklist procedures
- Attitude instrument flying
- Fundamental instrument skills
- Basic flight maneuvers
- Spatial disorientation demonstration
- Navigation systems
- Postflight procedures

### **Lesson 4—Attitude instrument flying**

#### **Ground Training**

- Human factors
- Flight instruments and systems
- Aircraft systems
- Navigation instruments and systems
- Attitude instrument flying
- Fundamental instrument skills
- Basic flight maneuvers

## **Flight Training**

Aircraft and instrument preflight inspection  
Checklist procedures  
Radio communications  
Attitude instrument flying  
Fundamental instrument skills  
Basic flight maneuvers  
Spatial disorientation  
Navigation  
Postflight procedures

## **Lesson 5—Aerodynamic factors and basic flight maneuvers**

### **Ground Training**

Basic aerodynamic factors  
Basic instrument flight patterns  
Emergency procedures

### **Flight Training**

Aircraft and instrument preflight inspection  
Checklist procedures  
Radio communications  
Basic instrument flight patterns  
Emergency procedures  
Navigation  
Postflight procedures

## **Lesson 6—Partial-panel operations**

### **Ground Training**

ATC system  
Flight instruments  
Partial-panel operations

### **Flight Training**

Aircraft and instrument preflight inspection  
Checklist procedures  
Radio communications  
Basic instrument flight patterns  
Emergency procedures  
Partial-panel practice  
Navigation  
Postflight procedures

## **Lesson 7—Recovery from unusual attitudes**

### **Ground Training**

Attitude instrument flying  
ATC system  
NAS overview

### **Flight Training**

Preflight  
Aircraft and instrument preflight inspection

Checklist procedures  
Radio communications  
Instrument takeoff  
Navigation  
Partial-panel practice  
Recovery from unusual attitudes  
Postflight procedures

## **Lesson 8—Navigation systems**

### **Ground Training**

ATC clearances  
Departure procedures  
IFR en route charts

### **Flight Training**

Aircraft and instrument preflight inspection  
Checklist procedures  
Radio communications  
Intercepting and tracking  
Holding  
Postflight procedures

## **Lesson 9—Review and practice**

### **Ground Training**

Aerodynamic factors  
Flight instruments and systems  
Attitude instrument flying  
Navigation systems  
NAS  
ATC  
Emergency procedures

### **Flight Training**

Aircraft and instrument preflight inspection  
Checklist procedures  
Radio communications  
Review and practice as determined by the flight instructor  
Instrument takeoff  
Radio communications  
Navigation systems  
Emergency procedures  
Postflight procedures

## **Lessons 10 through 19—Orientation, intercepting, tracking, and holding using each navigation system installed in the aircraft**

### **Ground Training**

Preflight planning  
Navigation systems  
NAS  
ATC  
Emergencies

### **Flight Training**

Aircraft and instrument preflight inspection  
Checklist procedures  
Radio communications  
Departure procedures  
En route navigation  
Terminal operations  
Partial-panel operation  
Instrument approach  
Missed approach  
Approach to a landing  
Postflight procedures

### **Lessons 20 and 21—Cross-country flights**

#### **Ground Training**

Preflight planning  
Aircraft performance  
Navigation systems  
NAS  
ATC  
Emergencies

#### **Flight Training**

Emergency procedures  
Partial-panel operation  
Aircraft and instrument preflight inspection  
Checklist procedures  
Radio communications  
Departure procedures  
En route navigation  
Terminal operations  
Instrument approach  
Missed approach  
Approach to a landing  
Postflight procedures

### **Lessons 22 and 23—Review and practice**

#### **Ground Training**

Human factors  
Aerodynamic factors  
Flight instruments and systems  
Attitude instrument flying  
Basic flight maneuvers  
Navigation systems  
NAS  
ATC  
Emergency operations

### **Flight Training**

Aircraft and instrument preflight inspection  
Checklist procedures  
Radio communications  
Review and practice as determined by the flight instructor  
Instrument takeoff  
Partial-panel operations  
Unusual attitude recoveries  
Radio communications  
Navigation systems  
Emergency procedures  
Postflight procedures

### **Lessons 24 and subsequent—Practical test preparation**

#### **Ground Training**

Title 14 of the Code of Federal Regulations (14 CFR) parts 61, 71, 91, 95, and 97  
*Instrument Flying Handbook*  
Practical test standards  
Administrative requirements  
Equipment requirements  
Applicant's requirements

#### **Flight Training**

Review and practice until the student can consistently perform all required tasks in accordance with the appropriate practical test standards.

**NOTE:** It is the recommending instructor's responsibility to ensure that the applicant meets part 61 requirements and is prepared for the practical test, including: training, knowledge, experience, and the appropriate instructor endorsements.





# Glossary

**absolute altitude.** The actual distance between an aircraft and the terrain over which it is flying.

**absolute pressure.** Pressure measured from the reference of zero pressure, or a vacuum.

**a.c.** Alternating current.

**acceleration error.** A magnetic compass error that shows up when the aircraft accelerates while flying on an easterly or westerly heading, causing the compass card to rotate toward North.

**accelerometer.** A part of an inertial navigation system (INS) that accurately measures the force of acceleration in one direction.

**ADF.** *See* automatic direction finder.

**ADI.** *See* attitude director indicator.

**ADM.** *See* aeronautical decision making.

**adverse yaw.** A flight condition at the beginning of a turn in which the nose of the aircraft starts to move in the direction opposite the direction the turn is being made, caused by the induced drag produced by the downward-deflected aileron holding back the wing as it begins to rise.

**aeronautical decision making (ADM).** A systematic approach to the mental process used by pilots to consistently determine the best course of action in response to a given set of circumstances.

**A/FD.** *See* Airport/Facility Directory.

**agonic line.** An irregular imaginary line across the surface of the Earth along which the magnetic and geographic poles are in alignment, and along which there is no magnetic variation.

**aircraft approach category.** A performance grouping of aircraft based on a speed of 1.3 times their stall speed in the landing configuration at maximum gross landing weight.

**AIRMET.** In-flight weather advisory issued as an amendment to the area forecast, concerning weather phenomena of operational interest to all aircraft and is potentially hazardous to aircraft with limited capability due to lack of equipment, instrumentation, or pilot qualifications.

**airport diagram.** The section of an instrument approach procedure chart that shows a detailed diagram of the airport including surface features and airport configuration information.

**Airport/Facility Directory (A/FD).** An FAA publication containing information on all airports, communications, and NAVAIDs.

**airport surface detection equipment (ASDE).** Radar equipment specifically designed to detect all principal features and traffic on the surface of an airport, presenting the entire image on the control tower console; used to augment visual observation by tower personnel of aircraft and/or vehicular movements on runways and taxiways.

**airport surveillance radar (ASR).** Approach control radar used to detect and display an aircraft's position in the terminal area.

**airport surveillance radar approach.** An instrument approach in which ATC issues instructions for pilot compliance based on aircraft position in relation to the final approach course, and the distance from the end of the runway as displayed on the controller's radar scope.

**air route surveillance radar (ARSR).** Air route traffic control center (ARTCC) radar used primarily to detect and display an aircraft's position while en route between terminal areas.

**air route traffic control center (ARTCC).** Provides ATC service to aircraft operating on IFR flight plans within controlled airspace and principally during the en route phase of flight.

**airways.** Based on a centerline that extends from one navigation aid or intersection to another navigation aid (or through several navigation aids or intersections); used to establish a known route for en route procedures between terminal areas.

**alert area.** An area in which there is a high volume of pilot training or an unusual type of aeronautical activity.

**almanac data.** Information the GPS receiver can obtain from one satellite which describes the approximate orbital positioning of all satellites in the constellation. This information is necessary for the GPS receiver to know what satellites to look for in the sky at a given time.

**ALS.** *See* approach lighting system.

**alternate airport.** Designated in an IFR flight plan, provides a suitable destination if a landing at the intended airport becomes inadvisable.

**alternate static source valve.** A valve in the instrument static air system that supplies reference air pressure to the altimeter, airspeed indicator, and vertical speed indicator if the normal static pickup should become clogged or iced over. This valve is accessible to the pilot in flight.

**altimeter setting.** Station pressure (the barometric pressure at the location the reading is taken) which has been corrected for the height of the station above sea level.

**amendment status.** The circulation date and revision number of an instrument approach procedure, printed above the procedure identification.

**ammeter.** An instrument installed in series with an electrical load to measure the amount of current flowing through the load.

**aneroid.** The sensitive component in an altimeter or barometer that measures the absolute pressure of the air. It is a sealed, flat capsule made of thin disks of corrugated metal soldered together and evacuated by pumping all of the air out of it.

**aneroid barometer.** An instrument that measures the absolute pressure of the atmosphere by balancing the weight of the air above it against the spring action of the aneroid.

**angle of attack.** The acute angle formed between the chord line of an airfoil and the direction of the air that strikes the airfoil.

**anti-ice.** System designed to prevent the accumulation of ice on an aircraft structure.

**approach lighting system (ALS).** Provides lights that will penetrate the atmosphere far enough from touchdown to give directional, distance, and glidepath information for safe transition from instrument to visual flight.

**area chart.** Part of the low-altitude en route chart series, these charts furnish terminal data at a larger scale for congested areas.

**area navigation (RNAV).** Allows a pilot to fly a selected course to a predetermined point without the need to overfly ground-based navigation facilities, by using waypoints.

**ARSR.** *See* air route surveillance radar.

**ARTCC.** *See* air route traffic control center.

**ASDE.** *See* airport surface detection equipment.

**ASR.** *See* airport surveillance radar.

**ATC.** Air Traffic Control.

**atmospheric propagation delay.** A bending of the electromagnetic (EM) wave from the satellite that creates an error in the GPS system.

**attitude director indicator (ADI).** An aircraft attitude indicator that incorporates flight command bars to provide pitch and roll commands.

**attitude indicator.** The basis for all instrument flight, this instrument reflects the airplane's attitude in relation to the horizon.

**attitude instrument flying.** Controlling the aircraft by reference to the instruments rather than outside visual cues.

**autokinesis.** Nighttime visual illusion that a stationary light is moving, which becomes apparent after several seconds of staring at the light.

**automatic direction finder (ADF).** Electronic navigation equipment that operates in the low- and medium-frequency bands. Used in conjunction with the ground-based non-directional beacon (NDB), the instrument displays the number of degrees clockwise from the nose of the aircraft to the station being received.

**back course (BC).** The reciprocal of the localizer course for an ILS. When flying a back-course approach, an aircraft approaches the instrument runway from the end at which the localizer antennas are installed.

**barometric scale.** A scale on the dial of an altimeter to which the pilot sets the barometric pressure level from which the altitude shown by the pointers is measured.

**BC.** *See* back course.

**block altitude.** A block of altitudes assigned by ATC to allow altitude deviations; for example, "Maintain block altitude 9 to 11 thousand."

**cake.** The black markings on the ball instrument indicating its neutral position.

**calibrated.** The instrument indication was compared with a standard value to determine the accuracy of the instrument.

**calibrated orifice.** A hole of specific diameter used to delay the pressure change in the case of a vertical speed indicator.

**CDI.** Course deviation indicator.

**changeover points (COPs).** A point along the route or airway segment between two adjacent navigation facilities or way-points where changeover in navigation guidance should occur.

**circling approach.** A maneuver initiated by the pilot to align the aircraft with a runway for landing when a straight-in landing from an instrument approach is not possible or is not desirable.

**Class A airspace.** Airspace from 18,000 feet MSL up to and including FL600, including the airspace overlying the waters within 12 NM of the coast of the 48 contiguous states and Alaska; and designated international airspace beyond 12 NM of the coast of the 48 contiguous states and Alaska within areas of domestic radio navigational signal or ATC radar coverage, and within which domestic procedures are applied.

**Class B airspace.** Airspace from the surface to 10,000 feet MSL surrounding the nation's busiest airports in terms of IFR operations or passenger numbers. The configuration of each Class B airspace is individually tailored and consists of a surface area and two or more layers, and is designed to contain all published instrument procedures once an aircraft enters the airspace. For all aircraft, an ATC clearance is required to operate in the area, and aircraft so cleared receive separation services within the airspace.

**Class C airspace.** Airspace from the surface to 4,000 feet above the airport elevation (charted in MSL) surrounding those airports having an operational control tower, serviced by radar approach control, and having a certain number of IFR operations or passenger numbers. Although the configuration of each Class C airspace area is individually tailored, the airspace usually consists of a 5 NM radius core surface area that extends from the surface up to 4,000 feet above the airport elevation, and a 10 NM radius shelf area that extends from 1,200 feet to 4,000 feet above the airport elevation.

**Class D airspace.** Airspace from the surface to 2,500 feet above the airport elevation (charted in MSL) surrounding those airports that have an operational control tower. The configuration of each Class D airspace area is individually tailored, and when instrument procedures are published, the airspace will normally be designed to contain the procedures.

**Class E airspace.** Airspace that is not Class A, Class B, Class C, or Class D, and it is controlled airspace.

**Class G airspace.** Airspace that is uncontrolled, except when associated with a temporary control tower, and has not been designated as Class A, Class B, Class C, Class D, or Class E airspace.

**clean configuration.** An aircraft in a clean configuration is one in which all flight control surfaces have been placed so as to create minimum drag; in most aircraft this means flaps and gear retracted.

**clearance.** Allows an aircraft to proceed under specified traffic conditions within controlled airspace, for the purpose of providing separation between known aircraft.

**clearance delivery.** Control tower position responsible for transmitting departure clearances to IFR flights.

**clearance limit.** The fix, point, or location to which an aircraft is cleared when issued an air traffic clearance.

**clearance on request.** After filing a flight plan, the IFR clearance has not yet been received but it is pending.

**clearance void time.** Used by ATC to advise an aircraft that the departure clearance is automatically canceled if takeoff is not made prior to a specified time. The pilot must obtain a new clearance or cancel the IFR flight plan if not off by the specified time.

**clear ice.** Glossy, clear, or translucent ice formed by the relatively slow freezing of large supercooled water droplets.

**compass course.** A true course corrected for variation and deviation errors.

**compass locator.** A low-power, low- or medium-frequency (L/MF) radio beacon installed at the site of the outer or middle marker of an ILS.

**compass rose.** A small circle graduated in 360° increments printed on navigational charts to show the amount of compass variation at different locations, or on instruments to indicate direction.

**computer navigation fix.** A point used to define a navigation track for an airborne computer system such as GPS or FMS.

**concentric rings.** The dashed-line circles depicted in the plan view of IAP charts, outside of the reference circle, that show en route and feeder facilities.

**cone of confusion.** A cone-shaped volume of airspace directly above a VOR station where no signal is received causing the CDI to fluctuate.

**control and performance.** A method of attitude instrument flying in which one instrument is used for making attitude changes, and the other instruments are used to monitor the progress of the change.

**controlled airspace.** An airspace of defined dimensions within which ATC service is provided to IFR and VFR flights in accordance with the airspace classification. Includes Class A, Class B, Class C, Class D, and Class E airspace.

**control pressures.** The amount of physical exertion on the control column necessary to achieve the desired aircraft attitude.

**convective.** Unstable, rising air—cumuliform clouds.

**convective SIGMET.** Weather advisory concerning convective weather significant to the safety of all aircraft, including thunderstorms, hail, and tornadoes.

**coordinated.** Using the controls to maintain or establish various conditions of flight with (1) a minimum disturbance of the forces maintaining equilibrium, or (2) the control action necessary to effect the smoothest changes in equilibrium.

**COPs.** *See* changeover points.

**Coriolis illusion.** An abrupt head movement, while in a prolonged constant-rate turn that has ceased stimulating the motion sensing system, can create the illusion of rotation or movement in an entirely different axis.

**crew resource management (CRM).** The effective use of all available resources—human resources, hardware, and information.

**critical areas.** Areas where disturbances to the ILS localizer and glide-slope courses may occur when surface vehicles or aircraft operate near the localizer or glide-slope antennas.

**CRM.** *See* crew resource management.

**cross-check.** The first fundamental skill of instrument flight, also known as “scan”; the continuous and logical observation of instruments for attitude and performance information.

**cruise clearance.** Used in an ATC clearance to allow a pilot to conduct flight at any altitude from the minimum IFR altitude up to and including the altitude specified in the clearance. Also authorizes a pilot to proceed to and make an approach at the destination airport.

**current induction.** An electrical current is induced into, or generated in, any conductor that is crossed by lines of flux from any magnet.

**DA.** *See* decision altitude.

**d.c.** Direct current.

**dark adaptation.** Physical and chemical adjustments of the eye that make vision possible in relative darkness.

**deceleration error.** A magnetic compass error that shows up when the aircraft decelerates while flying on an easterly or westerly heading, causing the compass card to rotate toward South.

**decision altitude (DA).** A specified altitude in the precision approach, charted in feet MSL, at which a missed approach must be initiated if the required visual reference to continue the approach has not been established.

**decision height (DH).** A specified altitude in the precision approach, charted in height above threshold elevation, at which a decision must be made to either continue the approach or to execute a missed approach.

**deice.** System designed to remove ice accumulation from an aircraft structure.

**density altitude.** Pressure altitude corrected for nonstandard temperature. Density altitude is used for computing the performance of an aircraft and its engines.

**departure procedure (DP).** Preplanned IFR ATC departure, published for pilot use, in textual and graphic format.

**deviation.** A magnetic compass error caused by local magnetic fields within the aircraft. Deviation error is different on each heading.

**DGPS.** Differential global positioning system.

**DH.** *See* decision height.

**direct indication.** The true and instantaneous reflection of aircraft pitch-and-bank attitude by the miniature aircraft, relative to the horizon bar of the attitude indicator.

**direct user access terminal system (DUATS).** Provides current FAA weather and flight plan filing services to certified civil pilots, via a personal computer, modem, and telephone access to the system. Pilots can request specific types of weather briefings and other pertinent data for planned flights.

**distance circle.** *See* reference circle.

**distance measuring equipment (DME).** A pulse-type electronic navigation system that shows the pilot, by an instrument-panel indication, the number of nautical miles between the aircraft and a ground station or waypoint.

**DME.** *See* distance measuring equipment.

**DME arc.** Flying a track that is a constant distance from the station or waypoint.

**DOD.** Department of Defense.

**doghouse.** A mark on the dial of a turn-and-slip indicator that has the shape of a doghouse.

**double gimbal.** A type of mount used for the gyro in an attitude instrument. The axes of the two gimbals are at right angles to the spin axis of the gyro, allowing free motion in two planes around the gyro.

**DP.** *See* departure procedure.

**DUATS.** *See* direct user access terminal system.

**duplex.** Transmitting on one frequency and receiving on a separate frequency.

**eddy currents.** Current induced in a metal cup or disc when it is crossed by lines of flux from a moving magnet.

**EFAS.** *See* En route Flight Advisory Service.

**EFC.** *See* expect-further-clearance.

**elevator illusion.** The feeling of being in a climb or descent, caused by the kind of abrupt vertical accelerations that result from up- or downdrafts.

**emergency.** A distress or urgent condition.

**emphasis error.** Giving too much attention to a particular instrument during the cross-check, instead of relying on a combination of instruments necessary for attitude and performance information.

**EM wave.** Electromagnetic wave.

**encoding altimeter.** A special type of pressure altimeter used to send a signal to the air traffic controller on the ground, showing the pressure altitude the aircraft is flying.

**en route facilities ring.** A circle depicted in the plan view of IAP charts, which designates NAVAIDs, fixes, and intersections that are part of the en route low altitude airway structure.

**En route Flight Advisory Service (EFAS).** An en route weather-only AFSS service.

**en route high-altitude charts.** Aeronautical charts for en route instrument navigation at or above 18,000 feet MSL.

**en route low-altitude charts.** Aeronautical charts for en route IFR navigation below 18,000 feet MSL.

**inverter.** A solid-state electronic device that converts electrical current from d.c. into a.c. to operate a.c. gyro-instruments.

**expect-further-clearance (EFC).** The time a pilot can expect to receive clearance beyond a clearance limit.

**FAF.** *See* final approach fix.

**false horizon.** Inaccurate visual information for aligning the aircraft caused by various natural and geometric formations that disorient the pilot from the actual horizon.

**federal airways.** Class E airspace areas that extend upward from 1,200 feet to, but not including, 18,000 feet MSL, unless otherwise specified.

**feeder facilities.** NAVAIDs used by ATC to direct aircraft to intervening fixes between the en route structure and the initial approach fix.

**final approach fix (FAF).** The fix from which the IFR final approach to an airport is executed, and which identifies the beginning of the final approach segment. An FAF is designated on government charts by the Maltese cross symbol for nonprecision approaches, and the lightning bolt symbol for precision approaches.

**fixating.** Staring at a single instrument, thereby interrupting the cross-check process.

**FL.** *See* flight level.

**flight configurations.** Adjusting the aircraft controls surfaces (including flaps and landing gear) in a manner that will achieve a specified attitude.

**flight level (FL).** A measure of altitude used by aircraft flying above 18,000 feet with the altimeter set at 29.92" Hg.

**flight management system (FMS).** Provides pilot and crew with highly accurate and automatic long-range navigation capability, blending available inputs from long- and short-range sensors.

**flightpath.** The line, course, or track along which an aircraft is flying or is intended to be flown.

**flight patterns.** Basic maneuvers, flown by reference to the instruments rather than outside visual cues, for the purpose of practicing basic attitude flying. The patterns simulate maneuvers encountered on instrument flights such as holding patterns, procedure turns, and approaches.

**flight strips.** Paper strips containing instrument flight information, used by ATC when processing flight plans.

**FMS.** *See* flight management system.

**fundamental skills.** Instrument cross-check, instrument interpretation, and aircraft control.

**glide slope (GS).** Part of the ILS that projects a radio beam upward at an angle of approximately 3° from the approach end of an instrument runway. The glide slope provides vertical guidance to aircraft on the final approach course for the aircraft to follow when making an ILS approach along the localizer path.

**glide-slope intercept altitude.** The minimum altitude of an intermediate approach segment prescribed for a precision approach that ensures obstacle clearance.

**global positioning system (GPS).** Navigation system that uses satellite rather than ground-based transmitters for location information.

**goniometer.** As used in radio frequency (RF) antenna systems, a direction-sensing device consisting of two fixed loops of wire oriented 90° from each other, which sense received signal strength separately and send those signals to two rotors (also oriented 90°) in the sealed direction-indicating instrument. The rotors are attached to the direction-indicating needle of the instrument and rotated by a small motor until minimum magnetic field is sensed near the rotors.

**GPS.** *See* global positioning system.

**GPS Approach Overlay Program.** An authorization for pilots to use GPS avionics under IFR for flying designated existing nonprecision instrument approach procedures, with the exception of LOC, LDA, and SDF procedures.

**graveyard spiral.** The illusion of the cessation of a turn while actually still in a prolonged coordinated, constant-rate turn, which can lead a disoriented pilot to a loss of control of the aircraft.

**great circle route.** The shortest distance across the surface of a sphere (the Earth) between two points on the surface.

**groundspeed.** Speed over the ground; either closing speed to the station or waypoint, or speed over the ground in whatever direction the aircraft is going at the moment, depending upon the navigation system used.

**GS.** *See* glide slope.

**HAA.** *See* height above airport.

**HAL.** *See* height above landing.

**HAT.** *See* height above touchdown elevation.

**hazardous attitudes.** Five aeronautical decision-making attitudes that may contribute to poor pilot judgment are: antiauthority, impulsivity, invulnerability, macho, and resignation.

**Hazardous Inflight Weather Advisory Service (HIWAS).** Recorded weather forecasts broadcast to airborne pilots over selected VORs.

**head-up display (HUD).** A special type of flight viewing screen that allows the pilot to watch the flight instruments and other data while looking through the windshield of the aircraft for other traffic, the approach lights, or the runway.

**height above airport (HAA).** The height of the MDA above the published airport elevation.

**height above landing (HAL).** The height above a designated helicopter landing area used for helicopter instrument approach procedures.

**height above touchdown elevation (HAT).** The DA/DH or MDA above the highest runway elevation in the touchdown zone (first 3,000 feet of the runway).

**HF.** High frequency.

**HIWAS.** *See* Hazardous Inflight Weather Advisory Service.

**holding.** A predetermined maneuver that keeps aircraft within a specified airspace while awaiting further clearance from ATC.

**holding pattern.** A racetrack pattern, involving two turns and two legs, used to keep an aircraft within a prescribed airspace with respect to a geographic fix. A standard pattern uses right turns; nonstandard patterns use left turns.

**homing.** Flying the aircraft on any heading required to keep the needle pointing directly to the 0° relative bearing position.

**horizontal situation indicator (HSI).** A flight navigation instrument that combines the heading indicator with a CDI, in order to provide the pilot with better situational awareness of location with respect to the courseline.

**HSI.** *See* horizontal situation indicator.

**HUD.** *See* head-up display.

**human factors.** A multidisciplinary field encompassing the behavioral and social sciences, engineering, and physiology, to consider the variables that influence individual and crew performance for the purpose of optimizing human performance and reducing errors.

**hypoxia.** A state of oxygen deficiency in the body sufficient to impair functions of the brain and other organs.

**IAF.** *See* initial approach fix.

**IAP.** *See* instrument approach procedures.

**ICAO.** *See* International Civil Aviation Organization.

**ident.** Push the button on the transponder to identify your return on the controller's scope.

**IFR.** *See* instrument flight rules.

**ILS.** *See* instrument landing system.

**ILS categories.** Categories of instrument approach procedures allowed at airports equipped with the following types of instrument landing systems:

ILS Category I: Provides for approach to a height above touchdown of not less than 200 feet, and with runway visual range of not less than 1,800 feet.

ILS Category II: Provides for approach to a height above touchdown of not less than 100 feet and with runway visual range of not less than 1,200 feet.

ILS Category IIIA: Provides for approach without a decision height minimum and with runway visual range of not less than 700 feet.

ILS Category IIIB: Provides for approach without a decision height minimum and with runway visual range of not less than 150 feet.

ILS Category IIIC: Provides for approach without a decision height minimum and without runway visual range minimum.

**IMC.** *See* instrument meteorological conditions.

**indirect indication.** A reflection of aircraft pitch-and-bank attitude by the instruments other than the attitude indicator.

**induced drag.** Drag caused by the same factors that produce lift; its amount varies inversely with airspeed. As airspeed decreases, the angle of attack must increase, and this increases induced drag.

**inertial navigation system (INS).** A computer-based navigation system that tracks the movement of an aircraft via signals produced by onboard accelerometers. The initial location of the aircraft is entered into the computer, and all subsequent movement of the aircraft is sensed and used to keep the position updated. An INS does not require any inputs from outside signals.

**initial approach fix (IAF).** The fix depicted on IAP charts where the IAP begins unless otherwise authorized by ATC.

**inoperative components.** Higher minimums are prescribed when the specified visual aids are not functioning; this information is listed in the Inoperative Components Table found in the U.S. Terminal Procedures Publications.

**INS.** *See* inertial navigation system.

**instrument approach procedures (IAP).** A series of predetermined maneuvers for the orderly transfer of an aircraft under IFR from the beginning of the initial approach to a landing or to a point from which a landing may be made visually.

**instrument flight rules (IFR).** Rules and regulations established by the Federal Aviation Administration to govern flight under conditions in which flight by outside visual reference is not safe. IFR flight depends upon flying by reference to instruments in the cockpit, and navigation is done by reference to electronic signals.

**instrument landing system (ILS).** An electronic system that provides both horizontal and vertical guidance to a specific runway, used to execute a precision instrument approach procedure.

**instrument meteorological conditions (IMC).** Meteorological conditions expressed in terms of visibility, distance from cloud, and ceiling less than the minimums specified for visual meteorological conditions, requiring operations to be conducted under IFR.

**instrument takeoff.** Using the instruments rather than outside visual cues to maintain runway heading and execute a safe takeoff.

**International Civil Aviation Organization (ICAO).** The United Nations agency for developing the principles and techniques of international air navigation, and fostering planning and development of international civil air transport.

**inversion illusion.** The feeling that the aircraft is tumbling backwards, caused by an abrupt change from climb to straight-and-level flight while in situations lacking visual reference.

**inverter.** A solid-state electronic device that converts d.c. into a.c. current of the proper voltage and frequency to operate a.c. gyro instruments.

**isogonic lines.** Lines drawn across aeronautical charts to connect points having the same magnetic variation.

**jet route.** A route designated to serve flight operations from 18,000 feet MSL, up to and including FL450.



**jet stream.** A high-velocity narrow stream of winds, usually found near the upper limit of the troposphere, which flows generally from west to east.

**Kollsman window.** A barometric scale window of a sensitive altimeter used to adjust the altitude for the altimeter setting.

**LAAS.** *See* local area augmentation system.

**lag.** The delay that occurs before an instrument needle attains a stable indication.

**land as soon as possible.** Land without delay at the nearest suitable area, such as an open field, at which a safe approach and landing is assured.

**land as soon as practical.** The landing site and duration of flight are at the discretion of the pilot. Extended flight beyond the nearest approved landing area is not recommended.

**land immediately.** The urgency of the landing is paramount. The primary consideration is to ensure the survival of the occupants. Landing in trees, water, or other unsafe areas should be considered only as a last resort.

**LDA.** *See* localizer-type directional aid.

**lead radial.** The radial at which the turn from the DME arc to the inbound course is started.

**leans, the.** An abrupt correction of a banked attitude, entered too slowly to stimulate the motion sensing system in the inner ear, can create the illusion of banking in the opposite direction.

**lines of flux.** Invisible lines of magnetic force passing between the poles of a magnet.

**LMM.** *See* locator middle marker.

**load factor.** The ratio of a specified load to the total weight of the aircraft. The specified load is expressed in terms of any of the following: aerodynamic forces, inertia forces, or ground or water reactions.

**loadmeter.** A type of ammeter installed between the generator output and the main bus in an aircraft electrical system.

**LOC.** *See* localizer.

**local area augmentation system (LAAS).** A differential global positioning system (DGPS) that improves the accuracy of the system by determining position error from the GPS satellites, then transmitting the error, or corrective factors, to the airborne GPS receiver.

**localizer (LOC).** The portion of an ILS that gives left/right guidance information down the centerline of the instrument runway for final approach.

**localizer-type directional aid (LDA).** A NAVAID used for nonprecision instrument approaches with utility and accuracy comparable to a localizer but which is not a part of a complete ILS and is not aligned with the runway. Some LDAs are equipped with a glide slope.

**locator middle marker (LMM).** NDB compass locator, colocated with a MM.

**locator outer marker (LOM).** NDB compass locator, colocated with an OM.

**LOM.** *See* locator outer marker.

**long range navigation (LORAN).** An electronic navigational system by which hyperbolic lines of position are determined by measuring the difference in the time of reception of synchronized pulse signals from two fixed transmitters. LORAN A operates in the 1750 to 1950 kHz frequency band. LORAN C and D operate in the 100 to 110 kHz frequency band.

**LORAN.** *See* long range navigation.

**lubber line.** The reference line used in a magnetic compass or heading indicator.

**MAA.** *See* maximum authorized altitude.

**magnetic bearing (MB).** The direction to or from a radio transmitting station measured relative to magnetic north.

**magnetic heading (MH).** The direction an aircraft is pointed with respect to magnetic north.

**mandatory altitude.** An altitude depicted on an instrument approach chart with the altitude value both underscored and overscored. Aircraft are required to maintain altitude at the depicted value.

**mandatory block altitude.** An altitude depicted on an instrument approach chart with two altitude values underscored and overscored. Aircraft are required to maintain altitude between the depicted values.

**MAP.** *See* missed approach point.

**margin identification.** The top and bottom areas on an instrument approach chart that depict information about the procedure, including airport location and procedure identification.

**marker beacon.** A low-powered transmitter that directs its signal upward in a small, fan-shaped pattern. Used along the flightpath when approaching an airport for landing, marker beacons indicate both aurally and visually when the aircraft is directly over the facility.

**maximum altitude.** An altitude depicted on an instrument approach chart with the altitude value overscored. Aircraft are required to maintain altitude at or below the depicted value.

**maximum authorized altitude (MAA).** A published altitude representing the maximum usable altitude or flight level for an airspace structure or route segment.

**MB.** *See* magnetic bearing.

**MCA.** *See* minimum crossing altitude.

**MDA.** *See* minimum descent altitude.

**MEA.** *See* minimum en route altitude.

**MH.** *See* magnetic heading.

**microwave landing system (MLS).** A precision instrument approach system operating in the microwave spectrum which normally consists of an azimuth station, elevation station, and precision distance measuring equipment.

**mileage breakdown.** A fix indicating a course change that appears on the chart as an “x” at a break between two segments of a federal airway.

**military operations area (MOA).** MOAs consist of airspace established for the purpose of separating certain military training activities from IFR traffic.

**Military Training Route (MTR).** Airspace of defined vertical and lateral dimensions established for the conduct of military training at airspeeds in excess of 250 KIAS.

**minimum altitude.** An altitude depicted on an instrument approach chart with the altitude value underscored. Aircraft are required to maintain altitude at or above the depicted value.

**minimum crossing altitude (MCA).** The lowest altitude at certain fixes at which an aircraft must cross when proceeding in the direction of a higher MEA.

**minimum descent altitude (MDA).** The lowest altitude (in feet MSL) to which descent is authorized on final approach, or during circle-to-land maneuvering in execution of a nonprecision approach.

**minimum en route altitude (MEA).** The lowest published altitude between radio fixes which ensures acceptable navigational signal coverage and meets obstacle clearance requirements between those fixes.

**minimum obstruction clearance altitude (MOCA).** The lowest published altitude in effect between radio fixes on VOR airways, off-airway routes, or route segments which meets obstacle clearance requirements for the entire route segment and which ensures acceptable navigational signal coverage only within 25 statute (22 nautical) miles of a VOR.

**minimum reception altitude (MRA).** The lowest altitude at which an airway intersection can be determined.

**minimum safe altitude (MSA).** The minimum altitude depicted on approach charts which provides at least 1,000 feet of obstacle clearance for emergency use within a specified distance from the listed navigation facility.

**minimum vectoring altitude (MVA).** An IFR altitude lower than the minimum en route altitude (MEA) that provides terrain and obstacle clearance.

**minimums section.** The area on an IAP chart that displays the lowest altitude and visibility requirements for the approach.

**missed approach.** A maneuver conducted by a pilot when an instrument approach cannot be completed to a landing.

**missed approach point (MAP).** A point prescribed in each instrument approach at which a missed approach procedure shall be executed if the required visual reference has not been established.

**mixed ice.** A mixture of clear ice and rime ice.

**MLS.** *See* microwave landing system.

**MM.** Middle marker.

**MOA.** *See* military operations area.

**MOCA.** *See* minimum obstruction clearance altitude.

**mode C.** Altitude reporting transponder mode.

**MRA.** *See* minimum reception altitude.

**MSA.** *See* minimum safe altitude.

**MTR.** *See* Military Training Route.

**MVA.** *See* minimum vectoring altitude.

**NACO.** *See* National Aeronautical Charting Office.

**NAS.** *See* National Airspace System.

**National Airspace System (NAS).** The common network of U.S. airspace—air navigation facilities, equipment and services, airports or landing areas; aeronautical charts, information and services; rules, regulations and procedures, technical information; and manpower and material.

**National Aeronautical Charting Office (NACO).** A Federal agency operating under the FAA, responsible for publishing charts such as the terminal procedures and en route charts.

**National Route Program (NRP).** A set of rules and procedures designed to increase the flexibility of user flight planning within published guidelines.

**National Security Area (NSA).** National Security Areas consist of airspace of defined vertical and lateral dimensions established at locations where there is a requirement for increased security and safety of ground facilities. Pilots are requested to voluntarily avoid flying through the depicted NSA. When it is necessary to provide a greater level of security and safety, flight in NSAs may be temporarily prohibited. Regulatory prohibitions are disseminated via NOTAMs.

**NM.** Nautical mile.

**NAV/COM.** Combined communication and navigation radio.

**NOAA.** National Oceanic and Atmospheric Administration.

**no-gyro approach.** A radar approach that may be used in case of a malfunctioning gyro-compass or directional gyro. Instead of providing the pilot with headings to be flown, the controller observes the radar track and issues control instructions “turn right/left” or “stop turn,” as appropriate.

**nonprecision approach.** A standard instrument approach procedure in which only horizontal guidance is provided.

**no procedure turn (NoPT).** Used with the appropriate course and altitude to denote the procedure turn is not required.

**NRP.** *See* National Route Program.

**NSA.** *See* National Security Area.

**NWS.** National Weather Service.

**OM.** Outer marker.

**omission error.** Failing to anticipate significant instrument indications following attitude changes; for example, concentrating on pitch control while forgetting about heading or roll information, resulting in erratic control of heading and bank.

**optical illusion.** A misleading visual image of features on the ground associated with landing, which causes a pilot to misread the spatial relationships between the aircraft and the runway.

**orientation.** Awareness of the position of the aircraft and of oneself in relation to a specific reference point.

**overcontrolling.** Using more movement in the control column than is necessary to achieve the desired pitch-and-bank condition.

**overpower.** Using more power than required for the purpose of achieving a faster rate of airspeed change.

**P-static.** *See* precipitation static.

**PAPI.** *See* precision approach path indicator.

**PAR.** *See* precision approach radar.

**parasite drag.** Drag caused by the friction of air moving over the aircraft structure; its amount varies directly with the airspeed. The higher the airspeed, the greater the parasite drag.

**PIC.** *See* pilot in command.

**pilot in command (PIC).** The pilot responsible for the operation and safety of an aircraft.

**pilot report (PIREP).** Report of meteorological phenomena encountered by aircraft.

**Pilot’s Operating Handbook/Airplane Flight Manual (POH/AFM).** FAA-approved documents published by the airframe manufacturer that list the operating conditions for a particular model of aircraft.

**PIREP.** *See* pilot report.

**pitot pressure.** Ram air pressure used to measure airspeed.

**pitot-static head.** A combination pickup used to sample pitot pressure and static air pressure.

**plan view.** The overhead view of an approach procedure on an instrument approach chart. The plan view depicts the routes that guide the pilot from the en route segments to the IAF.

**POH/AFM.** *See* Pilot’s Operating Handbook/Airplane Flight Manual.

**point in space approach.** A type of helicopter instrument approach procedure to a missed approach point more than 2,600 feet from an associated helicopter landing area.

**position error.** Error in the indication of the altimeter, ASI, and VSI caused by the air at the static system entrance not being absolutely still.

**position report.** A report over a known location as transmitted by an aircraft to ATC.

**precession.** The characteristic of a gyroscope that causes an applied force to be felt, not at the point of application, but 90° from that point in the direction of rotation.

**precipitation static (P-static).** A form of radio interference caused by rain, snow, or dust particles hitting the antenna and inducing a small radio-frequency voltage into it.

**precision approach.** A standard instrument approach procedure in which both vertical and horizontal guidance is provided.

**precision approach path indicator (PAPI).** Similar to the VASI but consisting of one row of lights in two- or four-light systems. A pilot on the correct glide slope will see two white lights and two red lights. *See* VASI.

**precision approach radar (PAR).** A type of radar used at an airport to guide an aircraft through the final stages of landing, providing both horizontal and vertical guidance. The radar operator directs the pilot to change heading or adjust the descent rate to keep the aircraft on a path that allows it to touch down at the correct spot on the runway.

**preferred IFR routes.** Routes established in the major terminal and en route environments to increase system efficiency and capacity. IFR clearances are issued based on these routes, listed in the A/FD except when severe weather avoidance procedures or other factors dictate otherwise.

**pressure altitude.** Altitude above the standard 29.92" Hg plane.

**prevailing visibility.** The greatest horizontal visibility equaled or exceeded throughout at least half the horizon circle (which is not necessarily continuous).

**primary and supporting.** A method of attitude instrument flying using the instrument that provides the most direct indication of attitude and performance.

**procedure turn.** A maneuver prescribed when it is necessary to reverse direction to establish an aircraft on the intermediate approach segment or final approach course.

**profile view.** Side view of an IAP chart illustrating the vertical approach path altitudes, headings, distances, and fixes.

**prohibited area.** Designated airspace within which flight of aircraft is prohibited.

**propeller/rotor modulation error.** Certain propeller RPM settings or helicopter rotor speeds can cause the VOR course deviation indicator (CDI) to fluctuate as much as  $\pm 6^\circ$ . Slight changes to the RPM setting will normally smooth out this roughness.

**rabbit, the.** High-intensity flasher system installed at many large airports. The flashers consist of a series of brilliant blue-white bursts of light flashing in sequence along the approach lights, giving the effect of a ball of light traveling towards the runway.

**radar.** Radio Detection And Ranging.

**radar approach.** The controller provides vectors while monitoring the progress of the flight with radar, guiding the pilot through the descent to the airport/heliport or to a specific runway.

**radials.** The courses oriented FROM the station.

**radio or radar altimeter.** An electronic altimeter that determines the height of an aircraft above the terrain by measuring the time needed for a pulse of radio-frequency energy to travel from the aircraft to the ground and return.

**radio magnetic indicator (RMI).** An electronic navigation instrument that combines a magnetic compass with an ADF or VOR. The card of the RMI acts as a gyro-stabilized magnetic compass, and shows the magnetic heading the aircraft is flying.

**radio wave.** An electromagnetic wave (EM wave) with frequency characteristics useful for radio transmission.

**RAIM.** *See* receiver autonomous integrity monitoring.

**random RNAV routes.** Direct routes, based on area navigation capability, between waypoints defined in terms of latitude/longitude coordinates, degree-distance fixes, or offsets from established routes/airways at a specified distance and direction.

**ranging signals.** Transmitted from the GPS satellite, these allow the aircraft's receiver to determine range (distance) from each satellite.

**RB.** *See* relative bearing.

**RBI.** *See* relative bearing indicator.

**RCO.** *See* remote communications outlet.

**receiver autonomous integrity monitoring (RAIM).** A system used to verify the usability of the received GPS signals and warns the pilot of any malfunction in the navigation system. This system is required for IFR-certified GPS units.

**recommended altitude.** An altitude depicted on an instrument approach chart with the altitude value neither underscored nor overscored. The depicted value is an advisory value.

**reference circle (also, distance circle).** The circle depicted in the plan view of an IAP chart that typically has a 10 NM radius, within which the elements are drawn to scale.

**regions of command.** The “regions of normal and reversed command” refers to the relationship between speed and the power required to maintain or change that speed in flight.

**REIL.** *See* runway end identifier lights.

**relative bearing (RB).** The angular difference between the aircraft heading and the direction to the station, measured clockwise from the nose of the aircraft.

**relative bearing indicator (RBI).** Also known as the fixed-card ADF, zero is always indicated at the top of the instrument and the needle indicates the relative bearing to the station.

**relative wind.** Direction of the airflow produced by an object moving through the air. The relative wind for an airplane in flight flows in a direction parallel with and opposite to the direction of flight; therefore, the actual flightpath of the airplane determines the direction of the relative wind.

**remote communications outlet (RCO).** An unmanned communications facility remotely controlled by air traffic personnel.

**restricted area.** Airspace designated under 14 CFR part 73 within which the flight of aircraft, while not wholly prohibited, is subject to restriction.

**reverse sensing.** When the VOR needle appears to be indicating the reverse of normal operation.

**RF.** Radio frequency.

**rigidity.** The characteristic of a gyroscope that prevents its axis of rotation tilting as the Earth rotates.

**rime ice.** Rough, milky, opaque ice formed by the instantaneous freezing of small supercooled water droplets.

**RMI.** *See* radio magnetic indicator.

**RNAV.** *See* area navigation.

**runway end identifier lights (REIL).** This system consists of a pair of synchronized flashing lights, located laterally on each side of the runway threshold, to provide rapid and positive identification of the approach end of a runway.

**runway visibility value (RVV).** The visibility determined for a particular runway by a transmissometer.

**runway visual range (RVR).** The instrumentally-derived horizontal distance a pilot should be able to see down the runway from the approach end, based on either the sighting of high-intensity runway lights, or the visual contrast of other objects.

**RVR.** *See* runway visual range.

**RVV.** *See* runway visibility value.

**SA.** *See* selective availability.

**St. Elmo’s Fire.** A corona discharge which lights up the aircraft surface areas where maximum static discharge occurs.

**satellite ephemeris data.** Data broadcast by the GPS satellite containing very accurate orbital data for that satellite, atmospheric propagation data, and satellite clock error data.

**scan.** The first fundamental skill of instrument flight, also known as “cross-check”; the continuous and logical observation of instruments for attitude and performance information.

**SDF.** *See* simplified directional facility.

**selective availability (SA).** A method by which the Department of Defense (DOD) can, in the interest of national security, create a significant clock and ephemeris error in the satellites, resulting in a navigation error.

**sensitive altimeter.** A form of multipointer pneumatic altimeter with an adjustable barometric scale that allows the reference pressure to be set to any desired level.

**SIGMET.** A weather advisory issued concerning weather significant to the safety of all aircraft.

**signal-to-noise ratio.** An indication of signal strength received compared to background noise, which is a measure of how adequate the received signal is.

**simplex.** Transmitting and receiving on the same frequency.

**simplified directional facility (SDF).** A NAVAID used for nonprecision instrument approaches. The final approach course is similar to that of an ILS localizer except that the SDF course may be offset from the runway, generally not more than 3°, and the course may be wider than the localizer, resulting in a lower degree of accuracy.

**situational awareness.** Knowing where you are in regard to location, air traffic control, weather, regulations, aircraft status, and other factors that may affect flight.

**skidding turn.** An uncoordinated turn in which the rate of turn is too great for the angle of bank, pulling the aircraft to the outside of the turn.

**slant range.** The horizontal distance from the aircraft antenna to the ground station, due to line-of-sight transmission of the DME signal.

**slaved-compass.** A system whereby the heading gyro “slaved to,” or continuously corrected to bring its direction readings into agreement with a remotely-located magnetic direction sensing device (usually a flux valve or flux gate compass).

**slipping turn.** An uncoordinated turn in which the aircraft is banked too much for the rate of turn, so the horizontal lift component is greater than the centrifugal force, pulling the aircraft toward the inside of the turn.

**small airplane.** An airplane of 12,500 pounds or less maximum certificated takeoff weight.

**somatogravic illusion.** The feeling of being in a nose-up or nose-down attitude, caused by a rapid acceleration or deceleration while in flight situations that lack visual reference.

**spatial disorientation.** The state of confusion due to misleading information being sent to the brain from various sensory organs, resulting in a lack of awareness of the aircraft position in relation to a specific reference point.

**special use airspace.** Airspace in which flight activities are subject to restrictions that can create limitations on the mixed use of airspace. Consists of prohibited, restricted, warning, military operations, and alert areas.

**SSV.** *See* standard service volume.

**standard holding pattern.** A holding pattern in which all turns are made to the right.

**standard-rate turn.** A turn in which an aircraft changes its direction at a rate of 3° per second (360° in 2 minutes) for low- or medium-speed aircraft. For high-speed aircraft, the standard-rate turn is 1-1/2° per second (360° in 4 minutes).

**standard service volume (SSV).** Defines the limits of the volume of airspace which the VOR serves.

**standard terminal arrival route (STAR).** A preplanned IFR ATC arrival procedure published for pilot use in graphic and/or textual form.

**STAR.** *See* standard terminal arrival route.

**static longitudinal stability.** The aerodynamic pitching moments required to return the aircraft to the equilibrium angle of attack.

**static pressure.** Pressure of the air that is still, or not moving, measured perpendicular to the surface of the aircraft.

**steep turns.** In instrument flight, anything greater than standard rate; in visual flight, anything greater than a 45° bank.

**stepdown fix.** Permits additional descent within a segment of an IAP by identifying a point at which an obstacle has been safely overflown.

**strapdown system.** An INS in which the accelerometers and gyros are permanently “strapped down” or aligned with the three axes of the aircraft.

**stress.** The body’s response to demands placed upon it.

**suction relief valve.** A relief valve in an instrument vacuum system to maintain the correct low pressure inside the instrument case for the proper operation of the gyros.

**synchro.** A device used to transmit indications of angular movement or position from one location to another.

**TAA.** *See* terminal arrival area.

**TACAN.** *See* tactical air navigation.

**tactical air navigation (TACAN).** An electronic navigation system used by military aircraft, providing both distance and direction information.

**TDZE.** *See* touch down zone elevation.

**TEC.** *See* Tower En route Control.

**technique.** The manner or style in which the procedures are executed.

**temporary flight restriction (TFR).** Restrictions to flight imposed in order to:

1. Protect persons and property in the air or on the surface from an existing or imminent flight associated hazard;
2. Provide a safe environment for the operation of disaster relief aircraft;
3. Prevent an unsafe congestion of sightseeing aircraft above an incident;
4. Protect the President, Vice President, or other public figures; and,
5. Provide a safe environment for space agency operations.

Pilots are expected to check appropriate NOTAMs during flight planning when conducting flight in an area where a temporary flight restriction is in effect.

**tension.** Maintaining an excessively strong grip on the control column; usually results in an overcontrolled situation.

**terminal arrival area (TAA).** The objective of the TAA procedure design is to provide a new transition method for arriving aircraft equipped with FMS and/or GPS navigational equipment. The TAA contains a “T” structure that normally provides a NoPT for aircraft using the approach.

**TFR.** *See* temporary flight restriction.

**thrust (aerodynamic force).** The forward aerodynamic force produced by a propeller, fan, or turbojet engine as it forces a mass of air to the rear, behind the aircraft.

**time and speed table.** A table depicted on an instrument approach procedure chart that identifies the distance from the FAF to the MAP, and provides the time required to transit that distance based on various groundspeeds.

**timed turn.** A turn in which the clock and the turn coordinator are used to change heading a definite number of degrees in a given time.

**Title 14 of the Code of Federal Regulations (14 CFR).** The federal aviation regulations governing the operation of aircraft, airways, and airmen.

**touchdown zone elevation (TDZE).** The highest elevation in the first 3,000 feet of the landing surface, TDZE is indicated on the instrument approach procedure chart when straight-in landing minimums are authorized.

**Tower En route Control (TEC).** The control of IFR en route traffic within delegated airspace between two or more adjacent approach control facilities, designed to expedite traffic and reduce control and pilot communication requirements.

**TPP.** *See* U.S. Terminal Procedures Publication.

**tracking.** Flying a heading that will maintain the desired track to or from the station regardless of crosswind conditions.

**Transcribed Weather Broadcast (TWEB).** Meteorological and aeronautical data is recorded on tapes and broadcast over selected NAVAIDs. Generally, the broadcast contains route-oriented data with specially prepared NWS forecasts, in-flight advisories, and winds aloft; plus selected current information such as weather reports (METAR/SPECI), NOTAMs, and special notices.

**transponder.** The airborne portion of the ATC radar beacon system.

**transponder code.** One of 4,096 four-digit discrete codes ATC will assign to distinguish between aircraft.

**trend.** Instruments showing an immediate indication of the direction of aircraft movement.

**trim.** Adjusting the aerodynamic forces on the control surfaces so that the aircraft maintains the set attitude without any control input.

**TWEB.** *See* Transcribed Weather Broadcast.

**uncaging.** Unlocking the gimbals of a gyroscopic instrument, making it susceptible to damage by abrupt flight maneuvers or rough handling.

**underpower.** Using less power than required for the purpose of achieving a faster rate of airspeed change.

**U.S. Terminal Procedures Publication (TPP).** Booklets published in regional format by the NACO that include DPs, STARs, IAPs, and other information pertinent to IFR flight.

**unusual attitude.** An unintentional, unanticipated, or extreme aircraft attitude.

**user-defined waypoints.** Waypoint location and other data which may be input by the user; this is the only GPS database that may be altered (edited) by the user.

**variation.** The compass error caused by the difference in the physical locations of the magnetic north pole and the geographic north pole.

**VASI.** *See* visual approach slope indicator.

**VDP.** *See* visual descent point.

**vectoring.** Navigational guidance by assigning headings.

**venturi tube.** A specially-shaped tube attached to the outside of an aircraft to produce suction to operate gyro instruments.

**very-high frequency omnidirectional range (VOR).** Electronic navigation equipment in which the cockpit instrument identifies the radial or line from the VOR station measured in degrees clockwise from magnetic north, along which the aircraft is located.

**vestibular.** The central cavity of the bony labyrinth of the ear, or the parts of the membranous labyrinth that it contains.

**VFR.** *See* visual flight rules.

**VFR-On-Top.** ATC authorization for an IFR aircraft to operate in VFR conditions at any appropriate VFR altitude.

**VFR Over-The-Top.** A VFR operation in which an aircraft operates in VFR conditions on top of an undercast.

**Victor airways.** Based on a centerline that extends from one VOR or VORTAC navigation aid or intersection, to another navigation aid (or through several navigation aids or intersections); used to establish a known route for en route procedures between terminal areas.

**visual approach slope indicator (VASI).** A system of lights arranged to provide visual descent guidance information during the approach to the runway. A pilot on the correct glide slope will see red lights over white lights.

**visual descent point (VDP).** A defined point on the final approach course of a nonprecision straight-in approach procedure from which normal descent from the MDA to the runway touchdown point may be commenced, provided the runway environment is clearly visible to the pilot.

**visual flight rules (VFR).** Flight rules adopted by the FAA governing aircraft flight using visual references. VFR operations specify the amount of ceiling and the visibility the pilot must have in order to operate according to these rules. When the weather conditions are such that the pilot can not operate according to VFR, he or she must use instrument flight rules (IFR).

**visual meteorological conditions (VMC).** Meteorological conditions expressed in terms of visibility, distance from cloud, and ceiling meeting or exceeding the minimums specified for VFR.

**VMC.** *See* visual meteorological conditions.

**VOR.** *See* very-high frequency omnidirectional range.

**VORTAC.** A facility consisting of two components, VOR and TACAN, which provides three individual services: VOR azimuth, TACAN azimuth, and TACAN distance (DME) at one site.

**VOR test facility (VOT).** A ground facility which emits a test signal to check VOR receiver accuracy. Some VOTs are available to the user while airborne, while others are limited to ground use only.

**WAAS.** *See* wide area augmentation system.

**warning area.** An area containing hazards to any aircraft not participating in the activities being conducted in the area. Warning areas may contain intensive military training, gunnery exercises, or special weapons testing.

**waypoint.** A designated geographical location used for route definition or progress-reporting purposes and is defined in terms of latitude/longitude coordinates.

**WCA.** *See* wind correction angle.

**wide area augmentation system (WAAS).** A differential global positioning system (DGPS) that improves the accuracy of the system by determining position error from the GPS satellites, then transmitting the error, or corrective factors, to the airborne GPS receiver.

**wind correction angle (WCA).** The angle between the desired track and the heading of the aircraft necessary to keep the aircraft tracking over the desired track.

**work.** A physical measurement of force used to produce movement.





# Index

## A

- acceleration ..... 1-3
  - error ..... 3-13
  - in cruise flight ..... 2-7
- ADF
  - components ..... 7-3
  - fixed-card ..... 7-3
  - function of ..... 7-4
  - movable-card ..... 7-3
  - operational errors ..... 7-7
  - orientation ..... 7-4
  - receiver ..... 7-3
- aerodynamic factors ..... 2-1
- aeronautical decision making (ADM) ..... 1-10
- Aeronautical Information Manual (AIM) ..... 10-1
- air route surveillance radar (ARSR) ..... 7-38
- air route traffic control center (ARTCC) ..... 9-4
- air traffic control towers ..... 9-5
- airborne equipment and ground facilities ..... 10-23
- aircraft control, helicopter ..... 6-3
- aircraft system malfunctions ..... 11-3
- airport diagram ..... 8-25
- airport information ..... 8-6
- airport surface detection equipment (ASDE) ..... 7-38
- airport surveillance radar (ASR) ..... 7-38, 10-18
- airport traffic control tower (ATCT) ..... 9-4
- Airport/Facility Directory (A/FD) ..... 10-1
- airspace classification ..... 8-1, 8-2
- airspeed ..... 3-7
  - calibrated ..... 3-7
  - color codes ..... 3-8
  - equivalent ..... 3-7
  - indicated ..... 3-7
  - true ..... 3-7
- airspeed indicators ..... 3-7
  - maximum allowable ..... 3-8
- alcohol ..... 1-10
- alert areas ..... 8-4
- alternator/generator failure ..... 11-3
- altimeter
  - absolute ..... 3-6
  - drum-type ..... 3-3
  - encoding ..... 3-6
  - errors ..... 3-4
  - sensitive ..... 3-3
- ANDS ..... 3-13
- anti-ice ..... 2-9
- approach
  - circling ..... 10-20
  - full ..... 10-14
  - missed ..... 10-22
  - no-gyro ..... 10-19
  - nonprecision ..... 7-18
  - parallel ..... 10-20
  - precision ..... 7-27, 10-19
  - radar ..... 10-17
  - radar vectors ..... 10-14
  - simultaneous ..... 10-20
  - surveillance ..... 10-18
  - timed ..... 10-19
  - to parallel runways ..... 10-20
- approach azimuth station ..... 7-36
- approach lighting systems ..... 7-30
- approach to airport
  - with an operating tower ..... 10-14
  - with tower and approach control ..... 10-17
  - with tower, no approach control ..... 10-14
  - without an operating control tower ..... 10-14
- approach/departure control ..... 9-10
- area chart ..... 8-6
- area navigation (RNAV) ..... 7-17
- atmosphere ..... 2-3
- attitude
  - control ..... 4-3
  - instrument flying, helicopter ..... 6-1
- attitude indicators ..... 3-18
- attitude instrument ..... 3-18
- autokinesis ..... 1-4
- automated flight service stations (AFSS) ..... 9-4

<b>B</b>		
ball instrument .....	2-8	
basic radio principles .....	7-1	
<b>C</b>		
C-R-A-F-T .....	9-5	
calibrated airspeed .....	3-7	
Category I approaches .....	7-29	
Category II approaches .....	7-29	
Category III approaches .....	7-29	
Center .....	9-5	
centrifugal force .....	2-7, 2-9	
centripetal force .....	2-7	
changeover points (COPs) .....	8-8	
charted IFR altitudes .....	8-7	
circling approaches .....	10-20	
clearance .....	10-3	
separations .....	10-4	
shorthand .....	9-6	
void time .....	9-11	
climbing		
while accelerating .....	1-5	
while turning .....	1-5	
climbs .....	2-7	
communication .....	9-1, 9-4	
equipment .....	9-1	
facilities .....	9-4	
communication/navigation system malfunction .....	11-4	
compass errors .....	3-10	
compass locator .....	7-30	
conducting an IFR flight		
arrival .....	10-35	
departure .....	10-33	
en route .....	10-34	
preflight .....	10-27	
control		
and performance method .....	4-1	
characteristics .....	2-5	
instruments .....	4-1	
procedural steps .....	4-2	
sequence .....	9-11	
controlled flight into terrain (CFIT) .....	3-6	
coordination		
of rudder and aileron controls .....	2-8	
coordination ball .....	3-22	
Coriolis illusion .....	1-3	
course deviation indicator (CDI)		
interpretation .....	7-11	
course interception .....	7-11	
crew/cockpit resource management (CRM) .....	1-13	
		cross-check .....
		common errors .....
		helicopter .....
		cruise clearance .....
		<b>D</b>
		dark adaptation .....
		deceleration .....
		DECIDE model .....
		deice .....
		density altitude .....
		departure .....
		control .....
		procedures (DPs) .....
		departures
		airports without an operating control tower .....
		radar controlled .....
		descent and approach, planning .....
		deviation .....
		dip errors .....
		directional gyros .....
		diving
		or rolling beyond the vertical plane .....
		spiral .....
		while turning .....
		DME .....
		components .....
		description .....
		errors .....
		function of .....
		DME arc .....
		DME holding .....
		drag curves .....
		duplex .....
		<b>E</b>
		ear .....
		inner .....
		electrical systems .....
		electromagnetic wave (EM wave) .....
		elevation guidance station .....
		elevator illusion .....
		emergencies, helicopter .....
		autorotations .....
		servo failure .....
		En route Flight Advisory Service (EFAS) .....
		en route high altitude charts .....
		en route procedures .....
		encoding altimeter .....
		equivalent airspeed .....
		eyes .....

## F

false horizon .....	1-4
fatigue .....	1-10
featureless terrain illusion .....	1-6
federal airways .....	8-4
filing in flight .....	10-3
fixation .....	4-3, 6-2
flight director systems .....	3-6, 3-22
flight management systems (FMS) .....	7-36
flight patterns, basic instrument	
80/260 procedure turn .....	5-35
circling approaches pattern .....	5-36
racetrack pattern .....	5-35
standard procedure turn .....	5-35
teardrop pattern .....	5-36
flight planning information, sources .....	10-1
flux gate compass .....	3-14
flying experience	
airborne equipment .....	10-23
ground facilities .....	10-23
instrument conditions, recency .....	10-23
fog .....	1-7, 10-25
four basic forces .....	2-1
full approach .....	10-14
fundamental skills	
aircraft control .....	4-7
cross-check .....	4-5
helicopter instrument flight .....	6-1
instrument interpretation .....	4-6

## G

glide slope .....	7-30, 7-34
glide-slope needle .....	7-32
GPS .....	7-21
components .....	7-21
database .....	7-21
description .....	7-21
errors .....	7-26
function of .....	7-22
IFR flight with .....	7-24
instrument approaches .....	7-25
substitution .....	7-22
graveyard spiral .....	1-3, 1-4
ground lighting illusions .....	1-7
ground proximity warning systems (GPWS) .....	3-6
ground wave .....	7-1
gyroscopic instruments .....	3-18
power systems .....	3-16

## H

hardware .....	1-13
hazardous attitudes .....	1-12
and antidotes .....	1-12
anti-authority .....	1-12
impulsivity .....	1-12
invulnerability .....	1-12
macho .....	1-12
resignation .....	1-12
haze .....	1-7
head-up display (HUD) .....	7-37
heading indicators .....	3-19
holding .....	10-10
airspeeds .....	10-12
direct entry .....	10-12
DME .....	10-13
instructions .....	10-11
maximum endurance speed .....	10-12
parallel entry .....	10-12
pattern .....	8-19
standard entry procedures .....	10-11
standard holding pattern (no wind) .....	10-10
standard holding pattern with wind .....	10-10
teardrop entry .....	10-12
time factors .....	10-13
homing .....	7-4
horizontal lift .....	2-7
horizontal situation indicator (HSI) .....	3-22, 7-10
human	
factors .....	1-1
resources .....	1-13

## I

ICAO Standard Atmosphere .....	2-3
icing .....	2-9
encounter, inadvertent .....	11-2
induction .....	2-9
structural .....	2-9
IFR altitudes, charted .....	8-7
IFR en route charts .....	8-6, 8-8
navigation features .....	8-8
IFR flight plan .....	10-2
cancelling .....	10-3
filing in flight .....	10-3
illusions .....	1-3
ILS .....	7-27
airborne components .....	7-32
components .....	7-29
description .....	7-27
errors .....	7-34
function .....	7-33

ILS critical areas .....	7-2
IMSAFE checklist .....	1-10
inclinometer .....	3-20
indicated airspeed .....	3-7
inertial navigation system (INS) .....	7-27
inertial reference systems (IRS) .....	7-27
information workload .....	1-13
inoperative components .....	8-28
inoperative or unusable	
components, substitutes for .....	10-10
instantaneous vertical speed indicators (IVSI) .....	3-9
instrument approach procedures (IAPs) .....	8-13, 10-14
charts .....	8-13–8-31
civil airports .....	10-14
instrument approach procedures, compliance with ...	10-13
instrument failure .....	11-3
instrument interpretation, helicopter .....	6-3
instrument systems, preflight procedures .....	3-23
after engine start .....	3-24
before engine start .....	3-23
engine shut down .....	3-24
taxiing and takeoff .....	3-24
instrument takeoff, helicopter	
common errors during .....	6-18
instrument takeoffs .....	5-33
common errors in .....	5-34
instrument weather flying .....	10-23
intersections, identifying .....	8-8
inversion illusion .....	1-4
inverted-V cross-check .....	4-5

**J**

jet routes .....	8-4
------------------	-----

**L**

lags or leads .....	3-13
land and hold short (LAHSO) .....	10-1
landing .....	10-22
large airplanes .....	2-7
Law of Inertia .....	2-1
Law of Momentum .....	2-2
Law of Reaction .....	2-2
lead radial .....	7-16
leans .....	1-3
letters of agreement (LOA) .....	9-11
lift .....	2-3
load factor .....	2-9
local area augmentation system (LAAS) .....	7-27
localizer (LOC)	
needle .....	7-29, 7-32
receiver .....	7-32

localizer type directional aid (LDA) .....	7-35
LORAN .....	7-19
accuracy .....	7-20
components .....	7-20
description .....	7-19
errors .....	7-20
function of .....	7-20

**M**

mach number .....	3-8
magnetic bearing (MB) .....	7-3
magnetic compass .....	3-9
vertical card .....	3-13
magnetic heading (MH) .....	7-3
margin identification .....	8-13
marker beacons .....	7-30
maximum allowable airspeed .....	3-8
maximum authorized altitude (MAA) .....	8-7
medical factors .....	1-9
alcohol .....	1-10
fatigue .....	1-10
microwave landing system (MLS) .....	7-35
military operations areas (MOAs) .....	8-4
Military Training Routes (MTRs) .....	8-4
minimum crossing altitude (MCA) .....	8-7
minimum en route altitude (MEA) .....	8-7
minimum obstruction clearance altitude (MOCA) .....	8-7
minimum reception altitude (MRA) .....	8-7
minimums and notes .....	8-23
missed approach procedure (MAP) .....	10-22
Mode C (altitude reporting) .....	9-3

**N**

National Airspace System (NAS) .....	8-1
National Route Program (NRP) .....	8-5
National Security Areas (NSAs) .....	8-4
navigation .....	8-8
features (NAVAIDs) .....	8-8
instruments .....	4-2
navigation/communication equipment .....	9-1
nerves .....	1-3
Newton's First Law of Motion .....	2-1
Newton's Second Law of Motion .....	2-2
Newton's Third Law of Motion .....	2-2
no-gyro approach under radar control .....	10-19
nondirectional beacon (NDB) .....	7-3
normal command .....	2-5
northerly turning error .....	3-12
nose-high attitudes .....	5-32
nose-low attitudes .....	5-32
Notices to Airmen (NOTAMs) .....	10-2
Notices to Airmen Publication .....	10-2

**O**

omnibearing selector (OBS) .....	7-9
optical illusions .....	1-6
featureless terrain illusion .....	1-6
fog .....	1-7
ground lighting illusions .....	1-7
haze .....	1-7
landing errors .....	1-7
runway and terrain slopes illusion .....	1-6
runway width illusion .....	1-6
water refraction .....	1-6
orientation .....	1-1
oscillation error .....	3-13

**P**

performance instruments .....	4-2
phonetic pronunciation guide .....	9-4
physiological and psychological factors .....	1-8
pitch/power relationship .....	2-3
pitot-static .....	
instruments .....	3-3
system .....	3-1
system failure .....	11-4
plan view .....	8-16
planning the descent and approach .....	10-8
pneumatic systems .....	3-16, 3-18
failure .....	11-4
POH/AFM .....	10-1, 10-2
position .....	
error .....	3-3
reports .....	10-7
postural .....	
orientation .....	1-1
system .....	1-4
power control .....	4-3
precipitation static (P-static) .....	7-2, 11-2
precision approach .....	7-27, 10-19
precision approach radar (PAR) .....	7-38
preferred IFR routes .....	8-4
preflight .....	10-27
pressure .....	
altimeter .....	3-3
altitude .....	2-3
primary and supporting method .....	4-3
bank instruments .....	4-3
pitch instruments .....	4-3
power instruments .....	4-3
procedure turns .....	8-18
profile view .....	8-20
prohibited areas .....	8-3
propeller modulation error .....	7-2

**R**

“rabbit, the” .....	7-31
radar .....	
approaches .....	10-17
transponders .....	9-3
vectors .....	10-14
radar controlled departures .....	10-5
radar navigation .....	7-37–7-39
radials .....	7-8
radio frequency .....	7-1
radio magnetic indicator (RMI) .....	7-3
radio wave .....	7-1, 7-2
ramp-down .....	7-26
range guidance station .....	7-36
rate instruments .....	3-20
rate of turn .....	2-8
recency of experience .....	10-23
rectangular cross-check .....	4-5
regions of command .....	2-5
normal command .....	2-5
reversed command .....	2-5
relative bearing (RB) .....	7-3
remote indicating compass .....	3-15
required navigational performance (RNP) .....	8-28
restricted areas .....	8-3
reversal of motion .....	1-5
reverse sensing .....	7-10
reversed command .....	2-6
RNAV .....	
description .....	7-17
VOR/DME .....	7-17
VOR/DME, components .....	7-17
VOR/DME, errors .....	7-19
VOR/DME, function of .....	7-18
RNAV en route high altitude charts .....	8-6
RNAV instrument approach charts .....	8-28
rudder and aileron controls, coordination of .....	2-8
runway .....	
and terrain slopes illusion .....	1-6
width illusion .....	1-6
runway end identifier lights (REIL) .....	7-32

**S**

scan .....	1-3, 6-1
selected radial cross-check .....	4-5
selective availability (SA) .....	7-26
sensitive altimeter, operation .....	3-3
side-step maneuver .....	10-20
signal strength indicators .....	7-10
simplex .....	9-1
simplified directional facility (SDF) .....	7-35
situational awareness .....	1-11
loss of .....	11-5

skidding turn .....	2-8
skids .....	1-3
sky wave .....	7-2
slaved gyro .....	3-15
slipping turn .....	2-8
slips .....	1-3
slow-speed flight .....	2-6
small airplanes .....	2-6
somatogravic illusion .....	1-4
space wave .....	7-2
spatial disorientation .....	1-1
coping with .....	1-6
demonstrating .....	1-5
special use airspace .....	8-3
speed stability .....	2-5
St. Elmo's Fire .....	11-2
stall, approach to .....	5-30
standard	
atmosphere .....	2-3
entry procedures .....	10-11
standard holding pattern	
no wind .....	10-10
with wind .....	10-10
standard terminal arrival routes (STARs) .....	10-8
static .....	7-2
straight climbs and descents	
climbs .....	5-16
common errors .....	5-22
descents .....	5-19
straight climbs and descents,	
helicopter; common errors .....	6-13
straight climbs; constant airspeed, constant rate	
entry .....	6-10
straight descents; constant airspeed, constant rate	
entry .....	6-12
straight-and-level flight	
bank control .....	5-7
common errors .....	5-14
pitch control .....	5-1
power control .....	5-9
trim technique .....	5-14
straight-and-level flight, helicopter	
bank control .....	6-6
common errors .....	6-7
pitch control .....	6-3
power control .....	6-8
stress .....	1-8
structural icing .....	10-24
surveillance approach .....	10-18

## T

temporary flight restrictions (TFRs) .....	8-4
terminal arrival area (TAA) .....	8-19
Terminal Instrument	
Approach Procedures (TERPs) .....	8-13
terminal radar approach control (TRACON) .....	9-6
terrain clearance .....	9-6
thunderstorm encounter, inadvertent .....	11-1
thunderstorms .....	10-25
tilting to right or left .....	1-5
time factors .....	10-13
TO/FROM indicator .....	7-10
tower en route control (TEC) .....	8-5, 9-9
tracking .....	7-5
transponders .....	3-6, 9-3
trim .....	2-6, 4-2
true airspeed .....	3-7
turbulence .....	10-23
turn .....	2-7
change of airspeed .....	5-28
climbing and descending .....	5-28
common errors .....	5-29
compass .....	5-25
coordinator .....	3-21
radius of .....	2-8
rate of .....	2-8
standard-rate .....	5-22
steep .....	5-26
timed .....	5-24
to predetermined heading .....	5-23
uncoordinated .....	1-3
turn, in helicopter .....	6-13–6-15
turn-and-slip indicator .....	3-20

## U

U.S. Terminal Procedures Publications .....	8-11
unforecast adverse weather .....	11-1
unusual attitudes	
and recoveries .....	5-33
common errors .....	5-33
recognizing .....	5-31
recovery .....	5-32
unusual attitudes, helicopter .....	6-16

## V

variation .....	3-10
venturi tube systems .....	3-16
vertical card magnetic compass .....	3-13
vertical lift component .....	2-7
vertical speed indicators (VSI) .....	3-8
vestibular orientation .....	1-1

VFR Over-The-Top .....	10-27
VFR-On-Top .....	10-27
victor airways .....	8-4
vision .....	1-8
visual .....	1-4
orientation .....	1-1
visual approach slope indicator (VASI) .....	7-32
visual glidepath .....	7-30
volcanic ash .....	10-25
VOR	
components .....	7-9
description .....	7-8
function of .....	7-10
operational errors .....	7-12
receiver accuracy check .....	7-12
VOT .....	7-13

## **W**

warning areas .....	8-3
water refraction .....	1-6
waypoint .....	7-18
weather .....	8-11
conditions, IFR flight .....	10-23
information and communication features .....	8-11
wet-type vacuum pump systems .....	3-17
wide area augmentation system (WAAS) .....	7-27
wind shear .....	10-26

## **Z**

zone of confusion .....	7-10
-------------------------	------



